

THIS DRAWING IS UNPUBLISHED. RELEASED FOR PUBLICATION
 © COPYRIGHT BY TYCO ELECTRONICS CORPORATION. ALL RIGHTS RESERVED.

LOC	DIST	REVISIONS			
P	LTR	DESCRIPTION	DATE	DWN	APVD
G	02	R1	REV PER ECR-06-001930	13FEB06	HMR TM

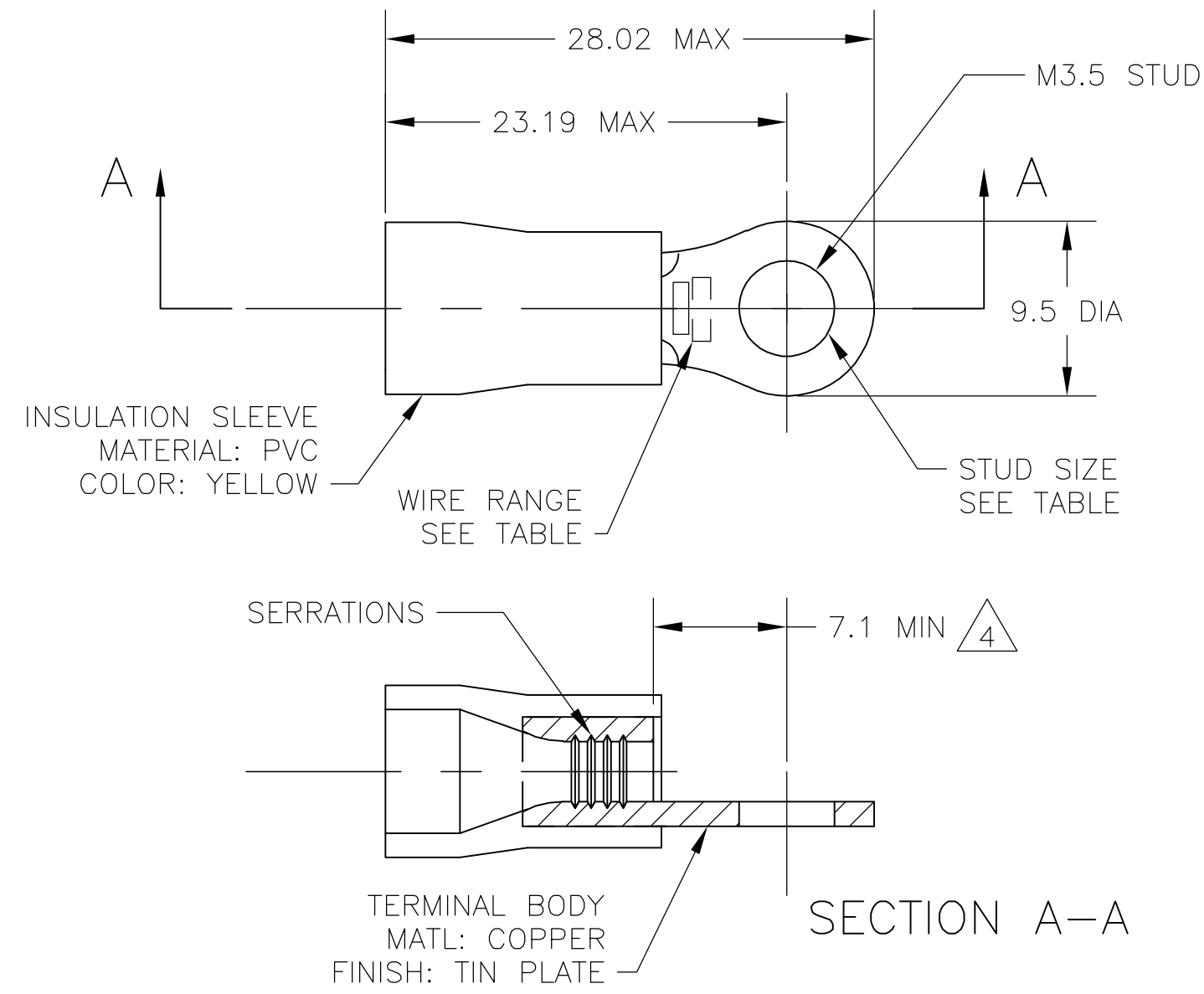

- 1 WIRE SIZE IS 12-10 AWG
- 2 WIRE INSULATION DIA: 3.8-6.4
- 3 MATERIAL THICKNESS IS 1.0
- 4 DIMENSION APPLIES FROM EDGE OF METAL WIRE BARREL TO END OF PIN.
- 5 SUPERSEDED BY 342182-1

POLY BAG WITH HEADER	STANDARD	50	5	7-342182-1
PLASTIC BOX	STANDARD	50	5	6-342182-1
TAPED MOUNTED	STANDARD	2500		2-342182-1
PLASTIC BAG	STANDARD	500		342182-1
PACKAGING	LABELLING	QTY		PART NO

THIS DRAWING IS A CONTROLLED DOCUMENT.		DWN jr ruth 02DEC05	tyco Tyco Electronics Corporation	
DIMENSIONS: INCHES		CHK T MICHELUTTI 02DEC05	Electronics Harrisburg, PA 17105-3608	
TOLERANCES UNLESS OTHERWISE SPECIFIED:		APVD T MICHELUTTI 02DEC05	NAME	
0 PLC ± -		PRODUCT SPEC	TERMINAL, RING TONGUE, PLASTI-GRIP,	
1 PLC ± 0.5		APPLICATION SPEC	-	
2 PLC ± -		WEIGHT	SIZE A2	CAGE CODE 00779
3 PLC ± -		MATERIAL	DRAWING NO C=342182	RESTRICTED TO
4 PLC ± -		FINISH	SCALE 5:1	SHEET 1 of 1
ANGLES ± 1°		CUSTOMER DRAWING	REV R1	