

# RF Power Field-Effect Transistor

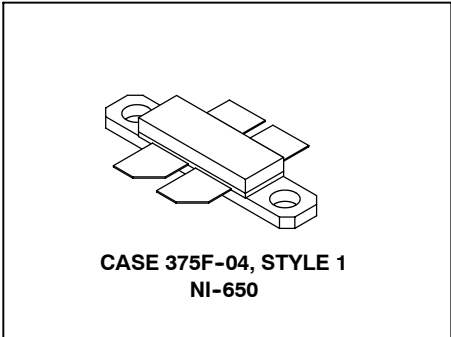
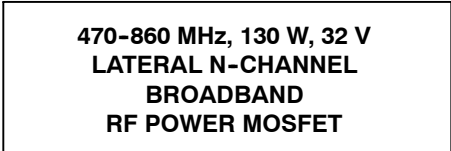
## N-Channel Enhancement-Mode Lateral MOSFET

Designed for broadband commercial and industrial applications with frequencies from 470 to 860 MHz. The high gain and broadband performance of this device make it ideal for large-signal, common source amplifier applications in 28/32 volt transmitter equipment.

- Typical Two-Tone Performance @ 860 MHz, 32 Volts, Narrowband Fixture  
 Output Power — 130 Watts PEP  
 Power Gain — 17.3 dB  
 Efficiency — 41%  
 IMD — -32.5 dBc
- Capable of Handling 10:1 VSWR @ 32 Vdc, 857 MHz, 130 Watts CW Output Power

### Features

- Integrated ESD Protection
- Excellent Thermal Stability
- Characterized with Differential Large-Signal Impedance Parameters
- RoHS Compliant



ARCHIVE INFORMATION

ARCHIVE INFORMATION

**Table 1. Maximum Ratings**

Rating	Symbol	Value	Unit
Drain-Source Voltage	$V_{DSS}$	-0.5, +70	Vdc
Gate-Source Voltage	$V_{GS}$	-0.5, +15	Vdc
Total Device Dissipation @ $T_C = 25^\circ\text{C}$ Derate above $25^\circ\text{C}$	$P_D$	302 1.72	W W/ $^\circ\text{C}$
Storage Temperature Range	$T_{stg}$	-65 to +150	$^\circ\text{C}$
Case Operating Temperature	$T_C$	150	$^\circ\text{C}$
Operating Junction Temperature	$T_J$	200	$^\circ\text{C}$

**Table 2. Thermal Characteristics**

Characteristic	Symbol	Value	Unit
Thermal Resistance, Junction to Case	$R_{\theta JC}$	0.58	$^\circ\text{C}/\text{W}$

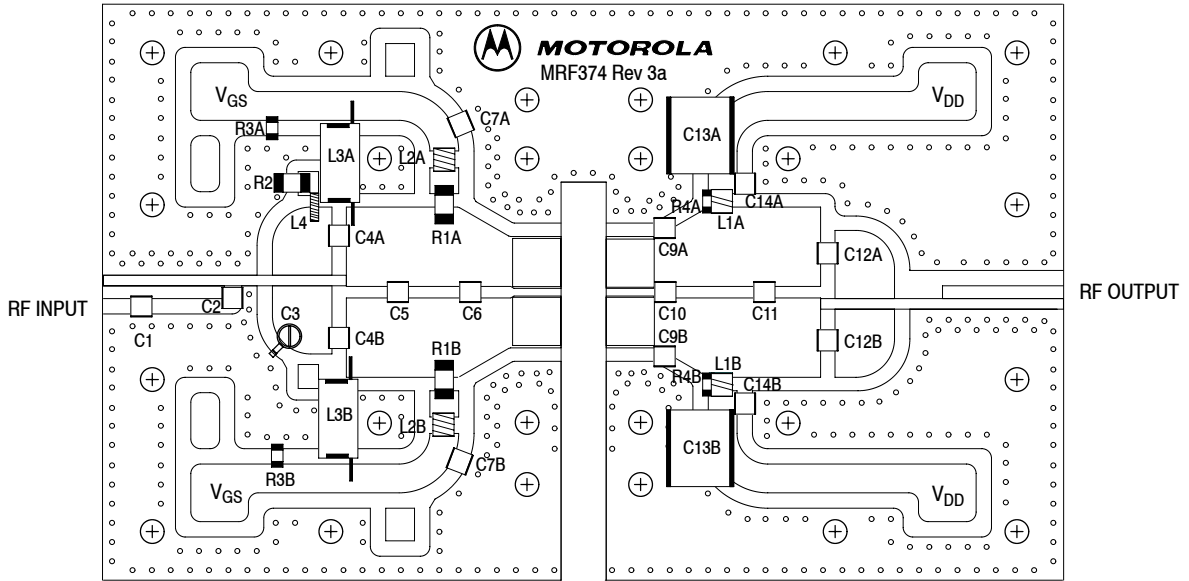
**Table 3. ESD Protection Characteristics**

Test Conditions	Class
Human Body Model	1 (Minimum)
Machine Model	M2 (Minimum)

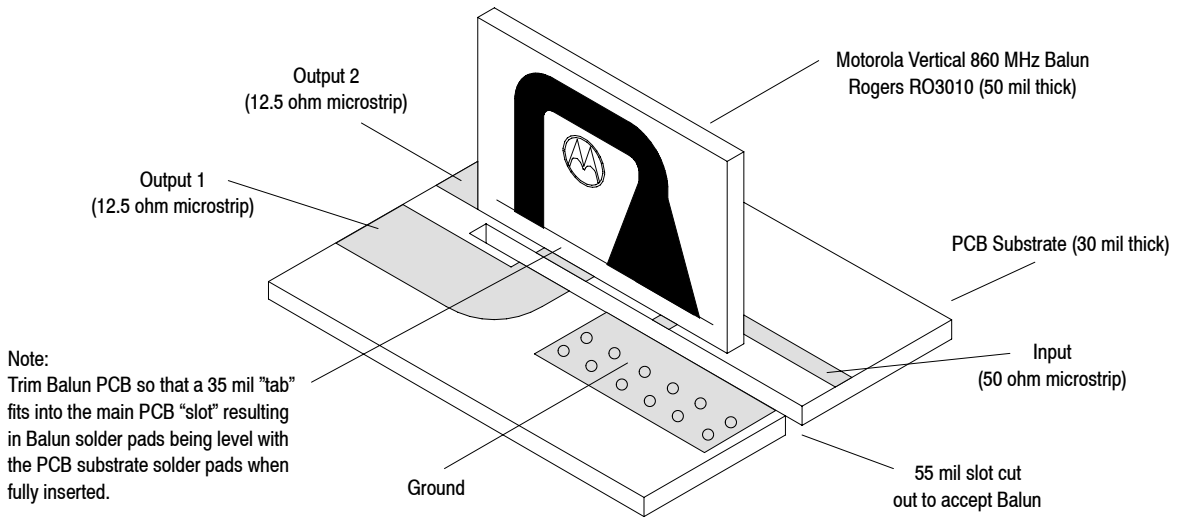
**Table 4. Electrical Characteristics** ( $T_C = 25^\circ\text{C}$  unless otherwise noted)

Characteristic	Symbol	Min	Typ	Max	Unit
<b>Off Characteristics</b> <sup>(1)</sup>					
Drain-Source Breakdown Voltage ( $V_{GS} = 0\text{ Vdc}$ , $I_D = 10\ \mu\text{A}$ )	$V_{(BR)DSS}$	70	—	—	Vdc
Zero Gate Voltage Drain Current ( $V_{DS} = 32\text{ Vdc}$ , $V_{GS} = 0\text{ Vdc}$ )	$I_{DSS}$	—	—	1	$\mu\text{Adc}$
Gate-Source Leakage Current ( $V_{GS} = 5\text{ Vdc}$ , $V_{DS} = 0\text{ Vdc}$ )	$I_{GSS}$	—	—	1	$\mu\text{Adc}$
<b>On Characteristics</b>					
Gate Threshold Voltage <sup>(1)</sup> ( $V_{DS} = 10\text{ V}$ , $I_D = 200\ \mu\text{A}$ )	$V_{GS(th)}$	2	2.9	4	Vdc
Gate Quiescent Voltage <sup>(2)</sup> ( $V_{DS} = 32\text{ V}$ , $I_D = 100\text{ mA}$ )	$V_{GS(Q)}$	2.5	3.3	4.5	Vdc
Drain-Source On-Voltage <sup>(1)</sup> ( $V_{GS} = 10\text{ V}$ , $I_D = 3\text{ A}$ )	$V_{DS(on)}$	—	0.41	0.45	Vdc
<b>Dynamic Characteristics</b> <sup>(1)</sup>					
Input Capacitance ( $V_{DS} = 32\text{ V}$ , $V_{GS} = 0\text{ V}$ , $f = 1\text{ MHz}$ )	$C_{iss}$	—	97.3	—	pF
Output Capacitance ( $V_{DS} = 32\text{ V}$ , $V_{GS} = 0\text{ V}$ , $f = 1\text{ MHz}$ )	$C_{oss}$	—	49	—	pF
Reverse Transfer Capacitance ( $V_{DS} = 32\text{ V}$ , $V_{GS} = 0\text{ V}$ , $f = 1\text{ MHz}$ )	$C_{rss}$	—	1.91	—	pF
<b>Functional Characteristics, Narrowband Operation</b> <sup>(2)</sup> (In Freescale MRF374A Narrowband Circuit, 50 ohm system)					
Common Source Power Gain ( $V_{DD} = 32\text{ Vdc}$ , $P_{out} = 130\text{ W PEP}$ , $I_{DQ} = 400\text{ mA}$ , $f_1 = 857\text{ MHz}$ , $f_2 = 863\text{ MHz}$ )	$G_{ps}$	16	17.3	—	dB
Drain Efficiency ( $V_{DD} = 32\text{ Vdc}$ , $P_{out} = 130\text{ W PEP}$ , $I_{DQ} = 400\text{ mA}$ , $f_1 = 857\text{ MHz}$ , $f_2 = 863\text{ MHz}$ )	$\eta$	36	41.2	—	%
Intermodulation Distortion ( $V_{DD} = 32\text{ Vdc}$ , $P_{out} = 130\text{ W PEP}$ , $I_{DQ} = 400\text{ mA}$ , $f_1 = 857\text{ MHz}$ , $f_2 = 863\text{ MHz}$ )	IMD	—	-32.5	-28	dB

1. Each side of device measured separately.
2. Measurement made with device in push-pull configuration.



**Vertical Balun Mounting Detail**



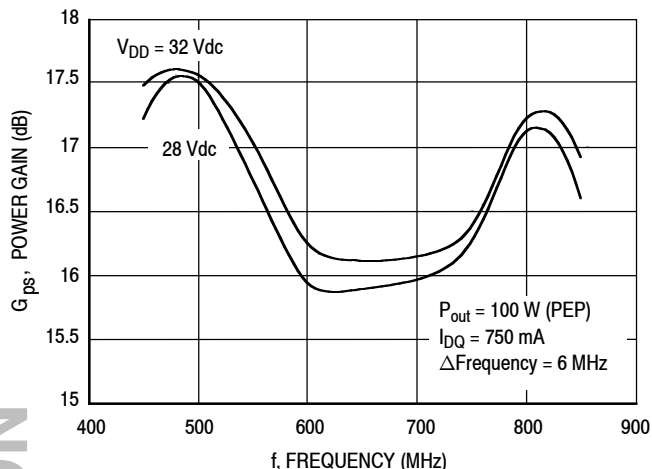
Freescale has begun the transition of marking Printed Circuit Boards (PCBs) with the Freescale Semiconductor signature/logo. PCBs may have either Motorola or Freescale markings during the transition period. These changes will have no impact on form, fit or function of the current product.

**Figure 1. MRF374A Narrowband Test Circuit Component Layout**

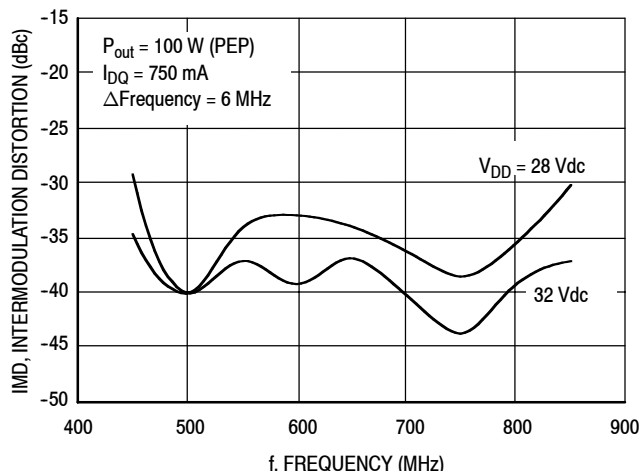
**Table 5. MRF374A Narrowband Test Circuit Component Layout Designations and Values**

Designation	Description
C1	0.8 pF Chip Capacitor, ATC
C2	2.2 pF Chip Capacitor, ATC
C3	0.5 - 5.0 pF Variable Capacitor, Johanson Gigatrim
C4A, B, C12A, B	47 pF Chip Capacitors, ATC
C5	1.0 pF Chip Capacitor, ATC
C6	10 pF Chip Capacitor, ATC
C7A, B, C14A, B	100,000 pF Chip Capacitors, ATC
C9A, B	15 pF Chip Capacitors, ATC
C10	3.9 pF Chip Capacitor, ATC
C11	5.1 pF Chip Capacitor, ATC
C13A, B	2.2 $\mu$ F, 100 V Chip Capacitors, Vishay #VJ3640Y225KXBAT
L1A, B	5.0 nH, Coilcraft #A02T
L2A, B	8.0 nH, Coilcraft #A03T
L3A, B	130.0 nH, Coilcraft #132-11SMJ
L4	8.8 nH, Coilcraft #1606-8
R1A, B	51 $\Omega$ , 1/4 W Chip Resistors, Vishay Dale (1210)
R2	10 $\Omega$ , 1/2 W Chip Resistor, Vishay Dale (2010)
R3A, B	3.3 k $\Omega$ , 1/8 W Chip Resistors, Vishay Dale (1206)
R4A, B	180 $\Omega$ , 1/4 W Chip Resistors, Vishay Dale (1210)
PCB	MRF374 Printed Circuit Board Rev 03, Rogers RO4350, Height 30 mils, $\epsilon_r = 3.48$
Balun B1A, B	Vertical 860 MHz Narrowband Balun, Printed Circuit Board Rev 01, Rogers RO3010, Height 50 mils, $\epsilon_r = 10.2$

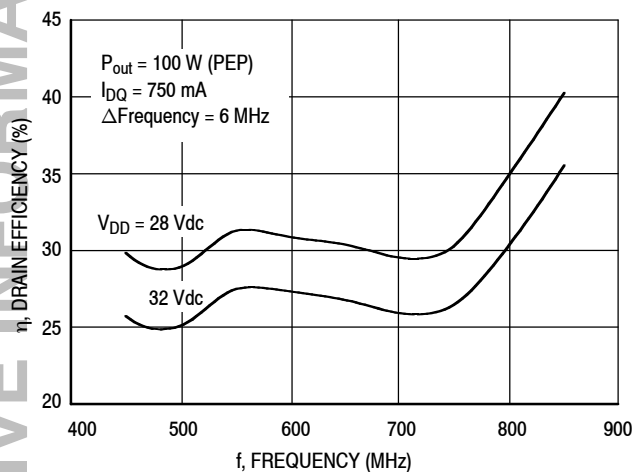
## TYPICAL CHARACTERISTICS



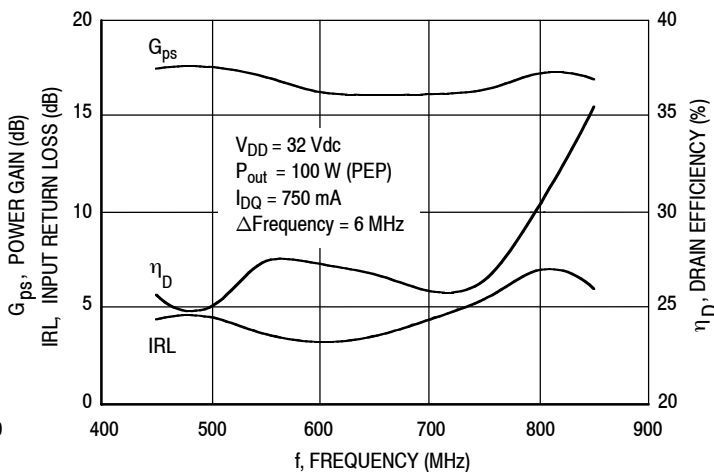
**Figure 2. Gain versus Frequency in Broadband Circuit**



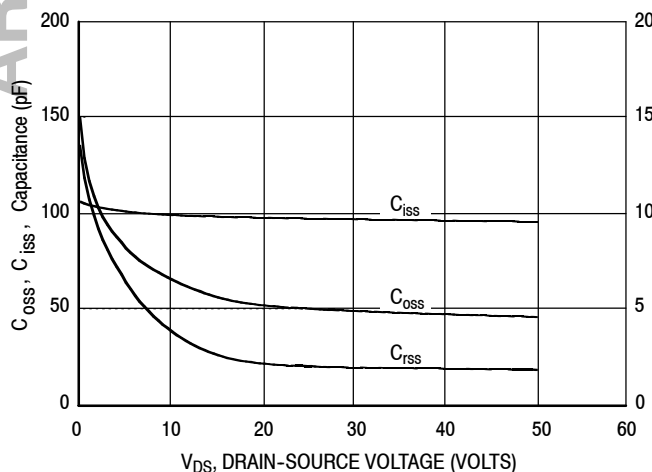
**Figure 3. Intermodulation Distortion versus Frequency in Broadband Circuit**



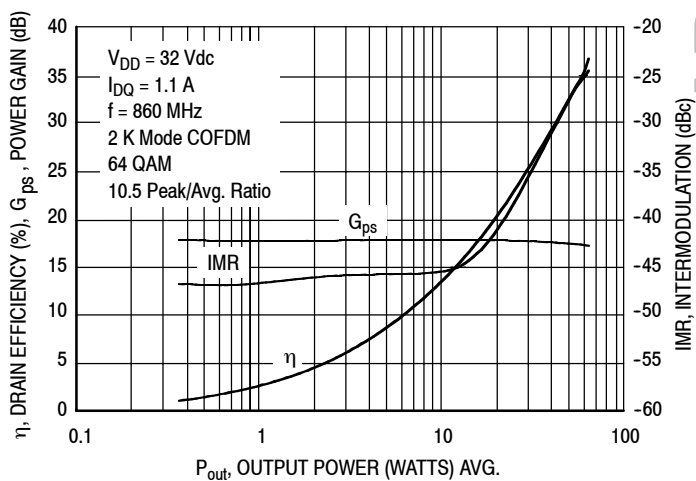
**Figure 4. Drain Efficiency versus Frequency in Broadband Circuit**



**Figure 5. Performance in Broadband Circuit**

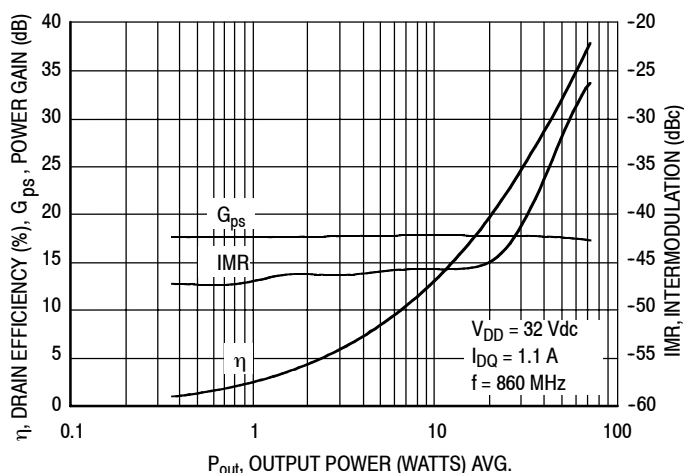


**Figure 6. Capacitance versus Voltage**

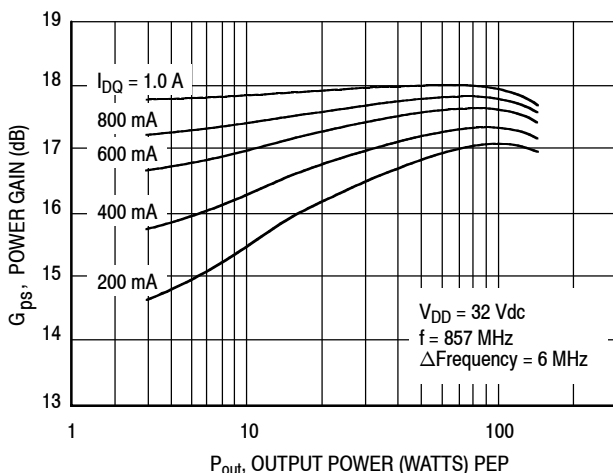


**Figure 7. COFDM Intermodulation, Gain and Efficiency versus Output Power in Broadband Circuit**

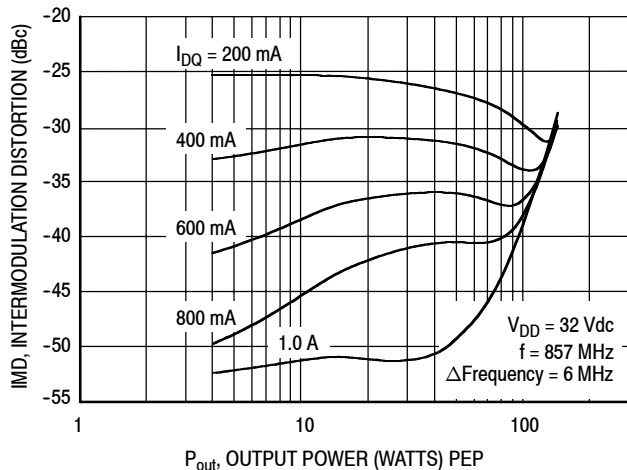
### TYPICAL CHARACTERISTICS



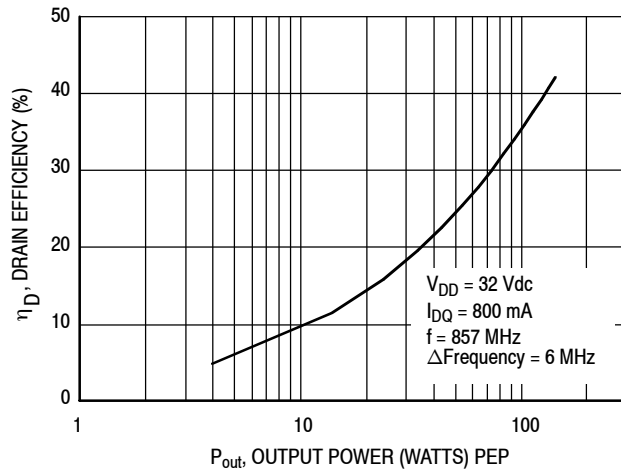
**Figure 8. 8-VSB Intermodulation, Gain and Efficiency versus Output Power in Broadband Circuit**



**Figure 9. Power Gain versus Peak Output Power in Narrowband Circuit**



**Figure 10. Intermodulation Distortion versus Peak Output Power in Narrowband Circuit**



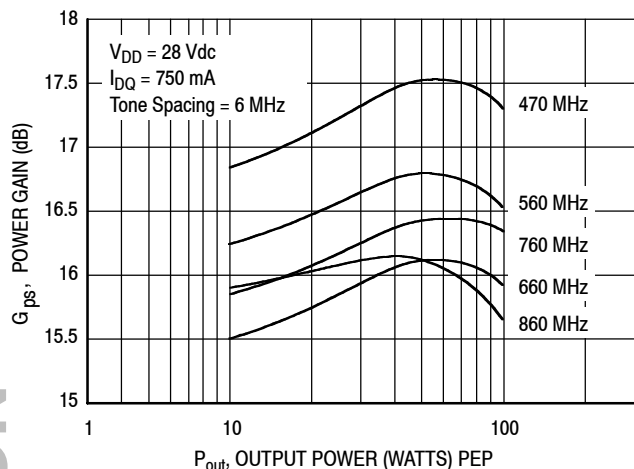
**Figure 11. Drain Efficiency versus Peak Output Power in Narrowband Circuit**

ARCHIVE INFORMATION

ARCHIVE INFORMATION

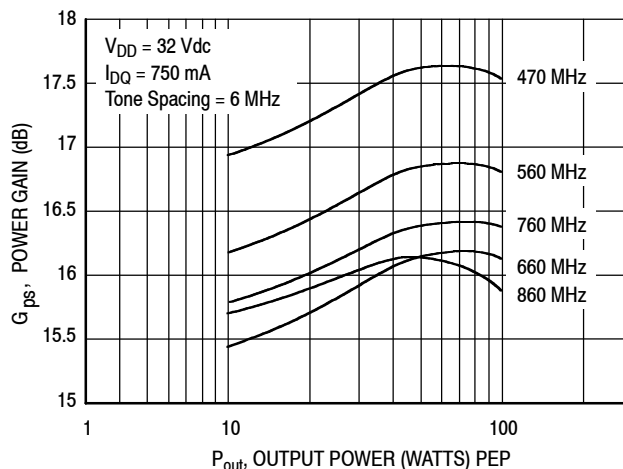
### TYPICAL CHARACTERISTICS

$V_{DD} = 28 \text{ Vdc}$

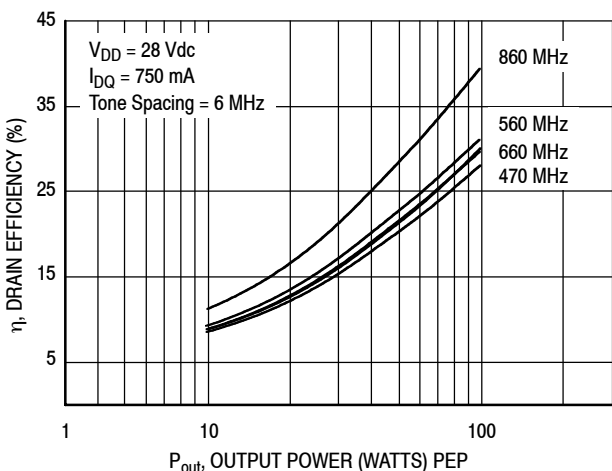


**Figure 12. Power Gain versus Peak Output Power in Broadband Circuit**

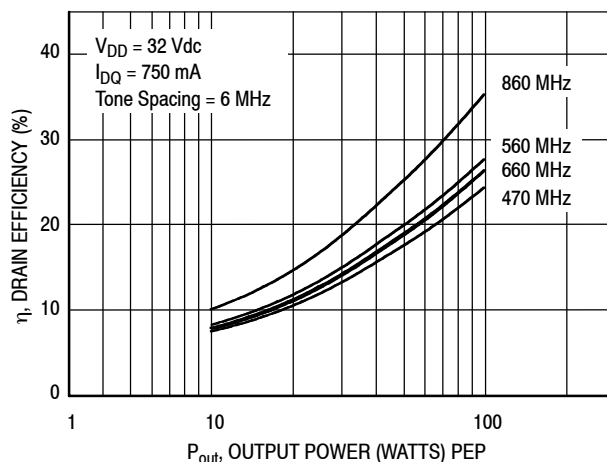
$V_{DD} = 32 \text{ Vdc}$



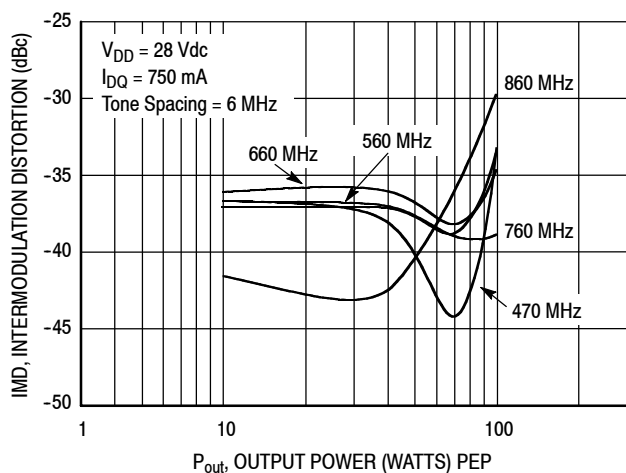
**Figure 13. Power Gain versus Peak Output Power in Broadband Circuit**



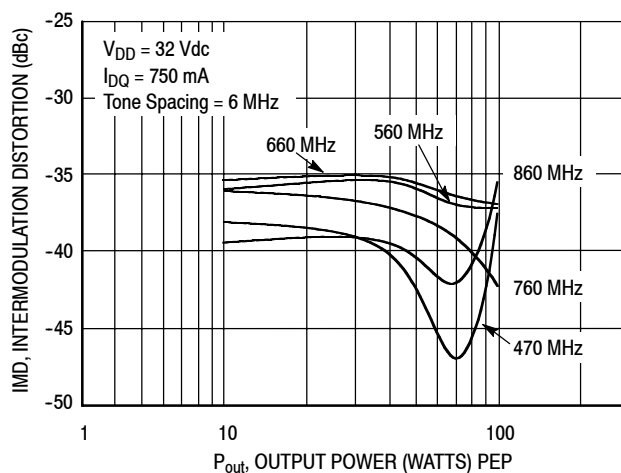
**Figure 14. Drain Efficiency versus Peak Output Power in Broadband Circuit**



**Figure 15. Drain Efficiency versus Peak Output Power in Broadband Circuit**



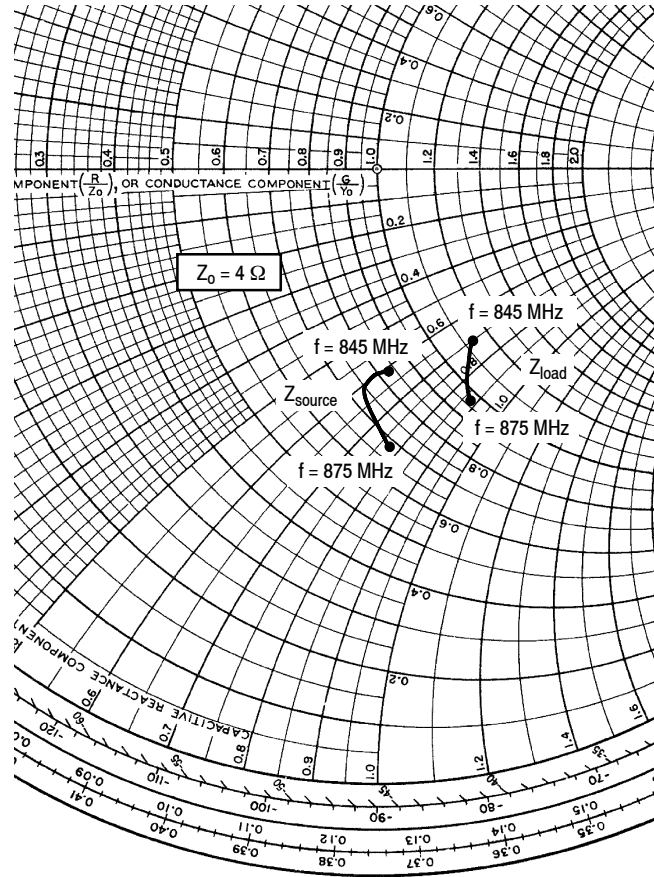
**Figure 16. Intermodulation Distortion versus Peak Output Power in Broadband Circuit**



**Figure 17. Intermodulation Distortion versus Peak Output Power in Broadband Circuit**

ARCHIVE INFORMATION

ARCHIVE INFORMATION



$V_{DD} = 32\text{ V}$ ,  $I_{DQ} = 400\text{ mA}$ ,  $P_{out} = 130\text{ W PEP}$

f MHz	$Z_{source}$ $\Omega$	$Z_{load}$ $\Omega$
845	$3.33 - j2.42$	$4.56 - j2.86$
860	$3.03 - j2.39$	$4.22 - j3.16$
875	$2.73 - j3.10$	$3.87 - j3.52$

$Z_{source}$  = Test circuit impedance as measured from gate to gate, balanced configuration.

$Z_{load}$  = Test circuit impedance as measured from drain to drain, balanced configuration.

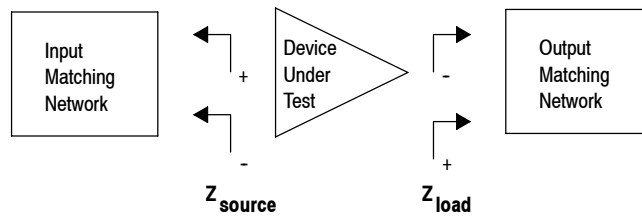


Figure 18. Series Equivalent Source and Load Impedance



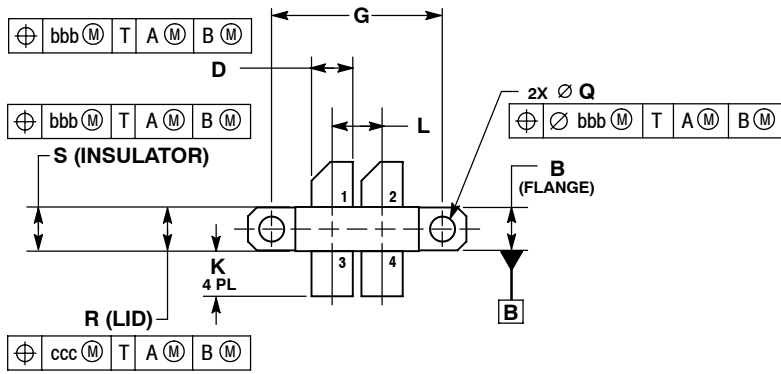
ARCHIVE INFORMATION

ARCHIVE INFORMATION

ARCHIVE INFORMATION

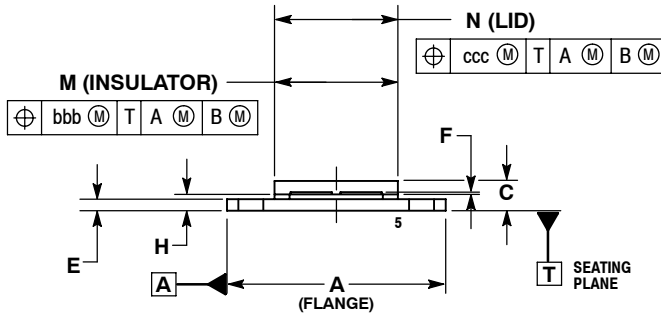
ARCHIVE INFORMATION

### PACKAGE DIMENSIONS



- NOTES:
1. DIMENSIONING AND TOLERANCING PER ANSI Y14.5M, 1994.
  2. CONTROLLING DIMENSION: INCH.
  3. DIMENSION H IS MEASURED 0.030 (0.762) AWAY FROM PACKAGE BODY.

DIM	INCHES		MILLIMETERS	
	MIN	MAX	MIN	MAX
A	1.135	1.145	28.80	29.10
B	0.225	0.235	5.72	5.97
C	0.135	0.178	3.43	4.52
D	0.210	0.220	5.33	5.59
E	0.055	0.065	1.40	1.65
F	0.004	0.006	0.11	0.15
G	0.900	BSC	22.86	BSC
H	0.077	0.087	1.96	2.21
K	0.220	0.250	5.59	6.35
L	0.260	BSC	6.60	BSC
M	0.643	0.657	16.33	16.69
N	0.638	0.650	16.20	16.50
Q	∅ .125	∅ .135	∅ 3.175	∅ 3.43
R	0.227	0.233	5.77	5.92
S	0.225	0.235	5.715	5.97
bbb	0.010	BSC	0.254	BSC
ccc	0.015	BSC	0.381	BSC



CASE 375F-04  
ISSUE E  
NI-650

- STYLE 1:  
PIN 1. DRAIN  
2. DRAIN  
3. GATE  
4. GATE  
5. SOURCE

ARCHIVE INFORMATION

ARCHIVE INFORMATION

**How to Reach Us:**

**Home Page:**  
www.freescale.com

**E-mail:**  
support@freescale.com

**USA/Europe or Locations Not Listed:**  
Freescale Semiconductor  
Technical Information Center, CH370  
1300 N. Alma School Road  
Chandler, Arizona 85224  
+1-800-521-6274 or +1-480-768-2130  
support@freescale.com

**Europe, Middle East, and Africa:**  
Freescale Halbleiter Deutschland GmbH  
Technical Information Center  
Schatzbogen 7  
81829 Muenchen, Germany  
+44 1296 380 456 (English)  
+46 8 52200080 (English)  
+49 89 92103 559 (German)  
+33 1 69 35 48 48 (French)  
support@freescale.com

**Japan:**  
Freescale Semiconductor Japan Ltd.  
Headquarters  
ARCO Tower 15F  
1-8-1, Shimo-Meguro, Meguro-ku,  
Tokyo 153-0064  
Japan  
0120 191014 or +81 3 5437 9125  
support.japan@freescale.com

**Asia/Pacific:**  
Freescale Semiconductor Hong Kong Ltd.  
Technical Information Center  
2 Dai King Street  
Tai Po Industrial Estate  
Tai Po, N.T., Hong Kong  
+800 2666 8080  
support.asia@freescale.com

**For Literature Requests Only:**  
Freescale Semiconductor Literature Distribution Center  
P.O. Box 5405  
Denver, Colorado 80217  
1-800-441-2447 or 303-675-2140  
Fax: 303-675-2150  
LDCForFreescaleSemiconductor@hibbertgroup.com

Information in this document is provided solely to enable system and software implementers to use Freescale Semiconductor products. There are no express or implied copyright licenses granted hereunder to design or fabricate any integrated circuits or integrated circuits based on the information in this document.

Freescale Semiconductor reserves the right to make changes without further notice to any products herein. Freescale Semiconductor makes no warranty, representation or guarantee regarding the suitability of its products for any particular purpose, nor does Freescale Semiconductor assume any liability arising out of the application or use of any product or circuit, and specifically disclaims any and all liability, including without limitation consequential or incidental damages. "Typical" parameters that may be provided in Freescale Semiconductor data sheets and/or specifications can and do vary in different applications and actual performance may vary over time. All operating parameters, including "Typicals", must be validated for each customer application by customer's technical experts. Freescale Semiconductor does not convey any license under its patent rights nor the rights of others. Freescale Semiconductor products are not designed, intended, or authorized for use as components in systems intended for surgical implant into the body, or other applications intended to support or sustain life, or for any other application in which the failure of the Freescale Semiconductor product could create a situation where personal injury or death may occur. Should Buyer purchase or use Freescale Semiconductor products for any such unintended or unauthorized application, Buyer shall indemnify and hold Freescale Semiconductor and its officers, employees, subsidiaries, affiliates, and distributors harmless against all claims, costs, damages, and expenses, and reasonable attorney fees arising out of, directly or indirectly, any claim of personal injury or death associated with such unintended or unauthorized use, even if such claim alleges that Freescale Semiconductor was negligent regarding the design or manufacture of the part.

Freescale™ and the Freescale logo are trademarks of Freescale Semiconductor, Inc. All other product or service names are the property of their respective owners.  
© Freescale Semiconductor, Inc. 2006, 2010. All rights reserved.