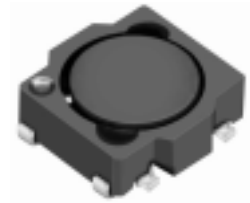
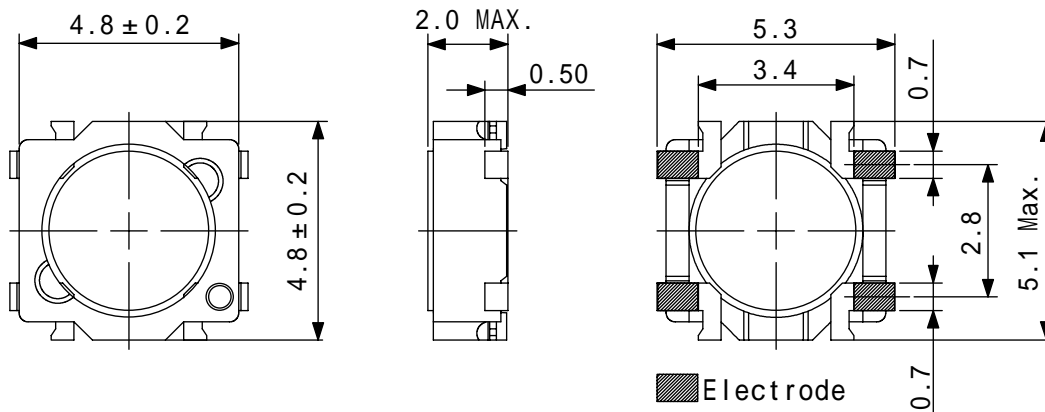
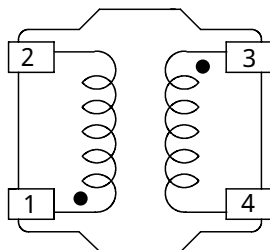

Type: CLS4D18
Description

- 4 Terminal pins' type gives a flexible design as inductors or transformers.
- Can also be used as a coupled inductor, two single inductors connected in parallel, as 1:1 transformer or as an autotransformer when connected in series.
- Core material: Ferrite.
- Custom design is available.

Feature

- Max. Operating frequency: 1MHz.
- 2 in 1 Coils for high efficiency up-down DC-DC converters.(SEPIC, Zeta, Cuk converter).
- Storage temperature range: -40 ~+105 .
- Operating temperature range: -40 ~+105 (including coil's self-heat).
- Product weight: 140mg(Ref.).
- Ideally used in the power supply for DSC, Note PC, DVC and W-LED backlighting.
- RoHS Compliance.

Dimensions (mm)

Schematics (Bottom)

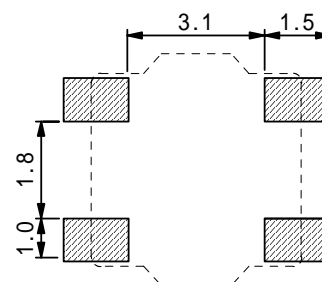
“●” indicates polarity.

Land Pattern (mm)

Type: CLS4D18
Specification

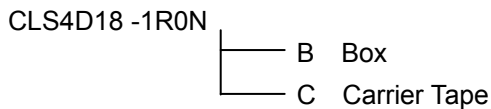
Part No.	Stamp	Inductance [Within]	D.C.R. [Max.] (m)		Saturation Current (A) ²				Temperature Rise current (A) ³	
			(at 20) ¹		In parallel		In series		In parallel	In series
			(2-1)	(4-3)	at 20	at 100	at 20	at 100		
CLS4D18-1R0N	A	1.0μH±30%	52(40)	64(49)	2.10	1.40	1.00	0.77	3.0	1.5
CLS4D18-1R8N	B	1.8μH±30%	69(53)	85(65)	1.50	1.10	0.72	0.56	2.7	1.2
CLS4D18-2R2N	C	2.2μH±30%	75(58)	95(73)	1.20	0.96	0.62	0.51	2.4	1.1
CLS4D18-3R3N	D	3.3μH±30%	95(72)	120(94)	1.10	0.80	0.52	0.40	2.3	0.9
CLS4D18-5R0N	E	5.0μH±30%	145(114)	185(145)	0.96	0.70	0.45	0.34	1.8	0.7
CLS4D18-6R8N	F	6.8μH±30%	175(134)	230(178)	0.72	0.62	0.39	0.30	1.6	0.65
CLS4D18 -100N	G	10μH±30%	310(240)	415(320)	0.64	0.51	0.32	0.26	1.2	0.47

Description of Part Name

- () typical value.
- Saturation Current: The DC current at which the inductance decreases to 90% of it's nominal value.
- Temperature rise current: The DC current at which the temperature rise is $t = 40$.($T_a = 20$).

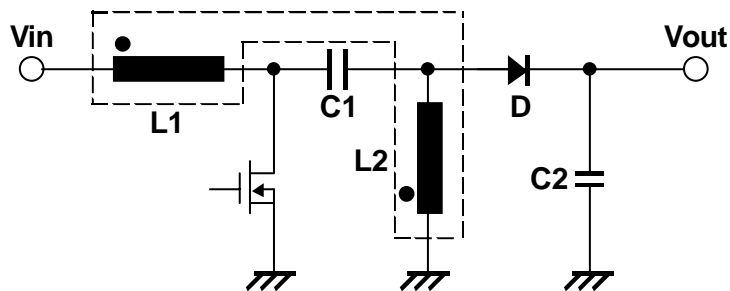
Typical SEPIC Schematic

Type: CLS4D18

Typical L Vs Current (REF.)

Parallel mode L vs I_{dc} (at 20) (REF.)

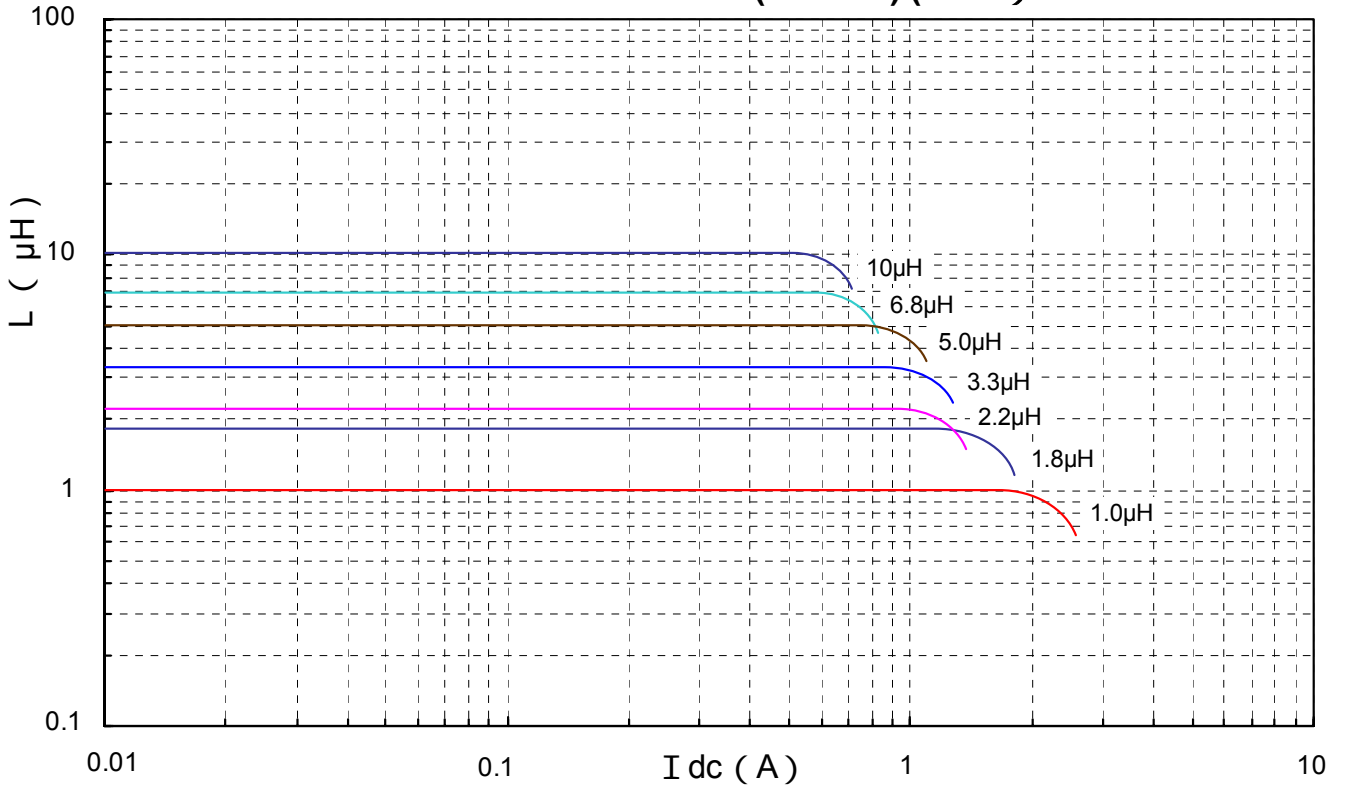

Series mode L vs I_{dc} (at 20) (REF.)

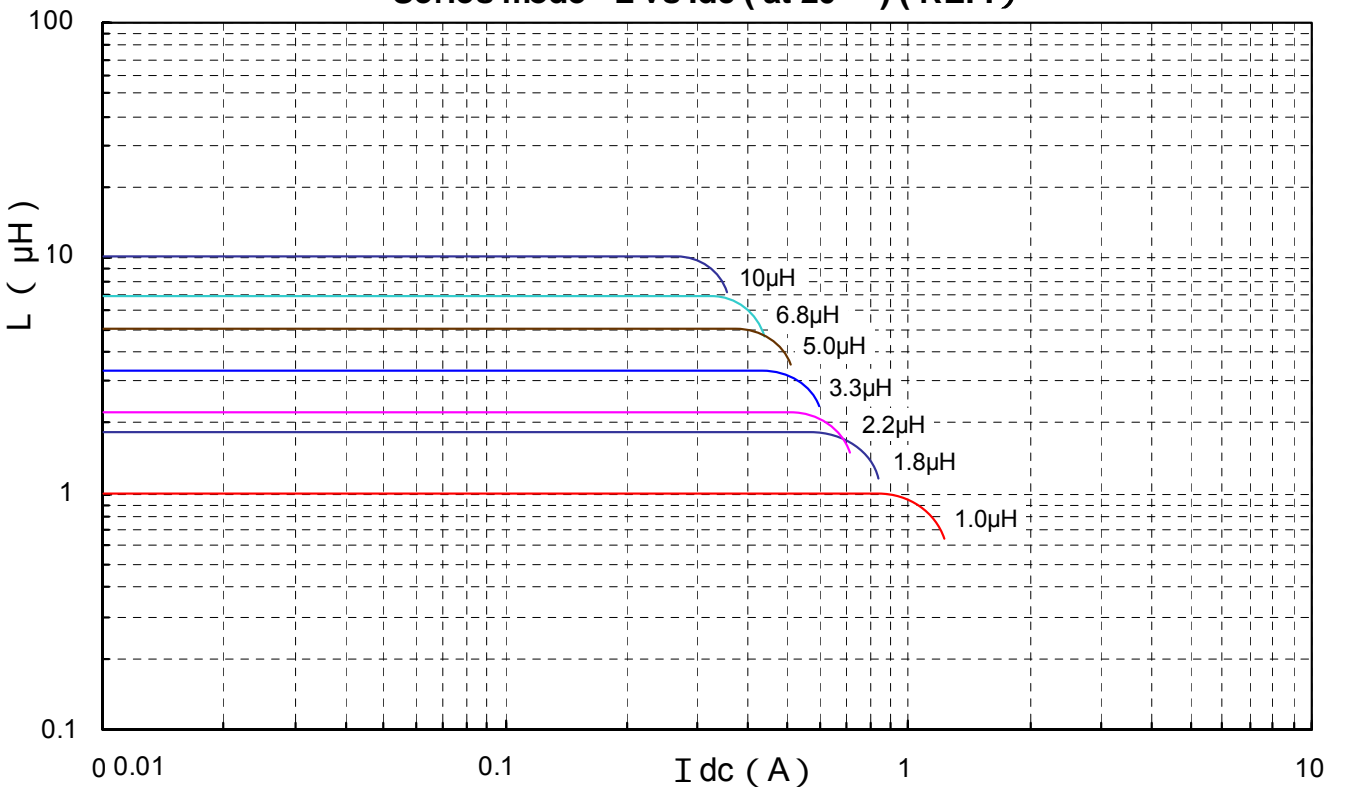

Type: CLS4D18

Recommendation Reflow Condition

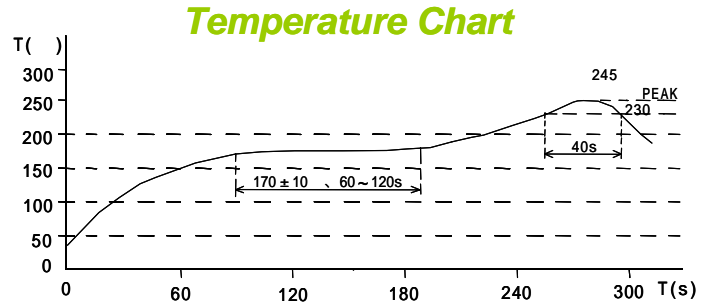
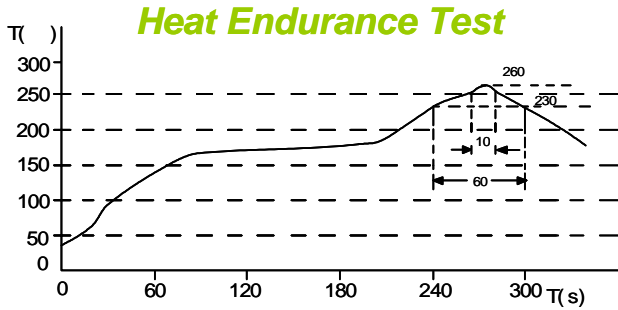

Packaging with Embossed Tape and Reel

Qty.: 1000pcs/reel

