

High Side Switch ICs 2ch

BD651xF Series BD20xxAFJ Series

●General Description

This High side switch IC for Universal Serial Bus (USB) is a high side switch that features over current protection used in power supply line of USB. Its switch unit has two channels of N-channel power MOSFET which are capable of current equal to 500mA for each channel. Moreover, it features over current detection, thermal shutdown, under voltage lockout and soft start circuit that are all built in.

●Features

- Dual N-MOS high side switch
- Continuous current load 0.5A
- Control input logic
Active-Low
Active-High
- Soft start circuit
- Over current detection
- Thermal shutdown
- Under voltage lockout
- Open drain error flag output
- Reverse-current protection when switch off
- Flag output delay filter built in

●Applications

USB hub in consumer appliances, Car accessory, PC, PC peripheral equipment, and so on.

●Typical Application Circuit

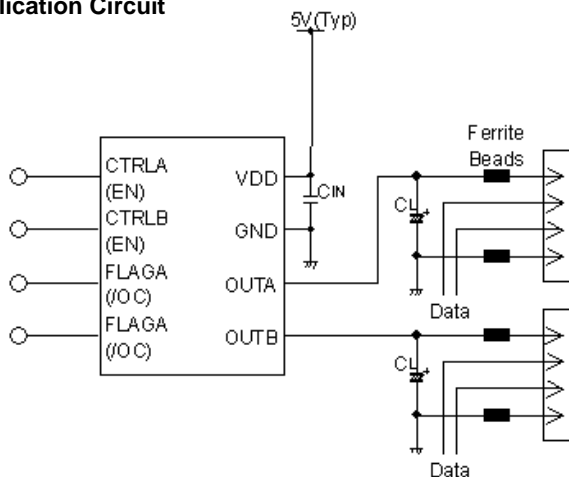

●Key Specifications

- Input voltage range:
 - BD651xF Series 3.0V to 5.5V
 - BD20xxAFJ Series 2.7V to 5.5V
- ON resistance :
 - BD6512F/BD6513F 100mΩ or 120mΩ(Typ.)
 - BD6516F/BD6517F 110mΩ or 140mΩ(Typ.)
 - BD2042FAFJ/BD2052AFJ 100 mΩ(Typ.)
- Over current threshold:
 - BD6512F/BD6513F 1.25A min., 2.2A max.
 - BD6516F/BD6517F 1.2A min., 2.5A max.
 - BD2042FAFJ/BD2052AFJ 0.7A min., 1.8A max.
- Standby current:
 - BD20xxAFJ Series 0.01μA (Typ.)
- Operating temperature range:
 - BD651xF Series -25°C to +85°C
 - BD20xxAFJ Series -40°C to +85°C

●Packages

- SOP8 W(Typ.) D(Typ.) H (Max.)
5.00mm x 6.20mm x 1.71mm
- SOP-J8 4.90mm x 6.00mm x 1.65mm

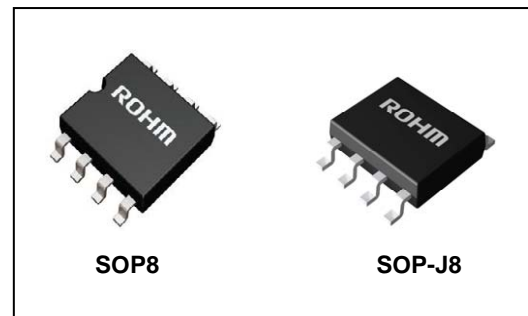

●Lineup

Over current threshold			Control input logic	Package	Orderable Part Number
Min.	Typ.	Max.			
1.25A	1.65A	2.2A	High	SOP8	BD6512F – E2
1.25A	1.65A	2.2A	Low		BD6513F – E2
1.2A	1.65A	2.5A	High		BD6516F – E2
1.2A	1.65A	2.5A	Low		BD6517F – E2
0.7A	1.0A	1.8A	High	SOP-J8	BD2042AFJ – E2
0.7A	1.0A	1.8A	Low		BD2052AFJ – E2

○Product structure : Silicon monolithic integrated circuit ○This product has no designed protection against radioactive rays

●Block Diagrams

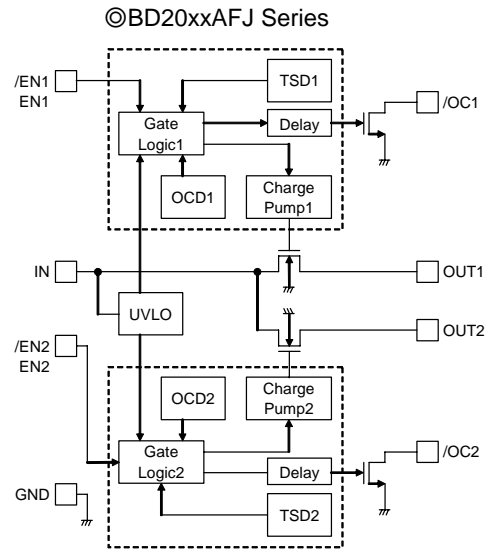
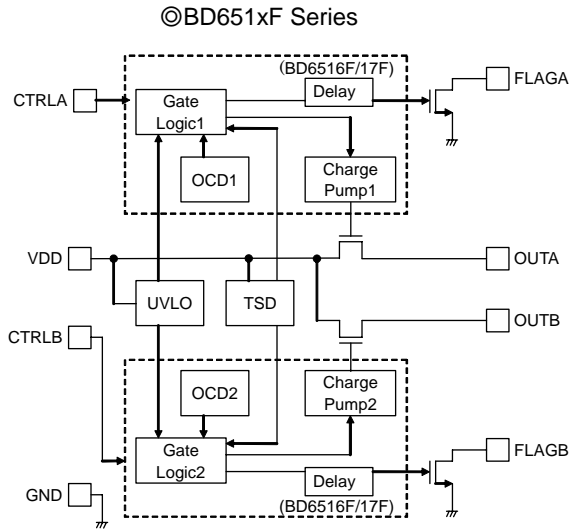

●Pin Configurations

BD651xF Series
TOP VIEW

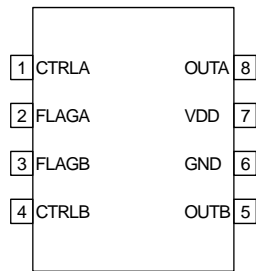

BD20xxAFJ Series
TOP VIEW

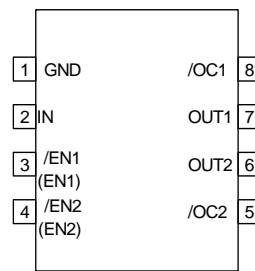

●Pin Descriptions

©BD651xF Series

Pin No.	Symbol	I / O	Pin function
1, 4	CTRLA CTRLB	I	Enable input. Switch ON at Low level. (BD6513F/BD6517F) Low level input < 0.7V. Switch ON at High level. (BD6512F/BD6516F) High level input > 2.5V.
2, 3	FLAGA FLAGB	O	Error flag output. Low at over current, thermal shutdown. Open drain output.
5, 8	OUTB OUTA	O	Switch output.
6	GND	I	Ground.
7	VDD	I	Power supply input. Input terminal of the switch and power supply of internal circuit.

©BD20xxAFJ Series

Pin. No.	Symbol	I / O	Pin function
1	GND	I	Ground.
2	IN	I	Power supply input. Input terminal of the switch and power supply of internal circuit.
3, 4	/EN, EN	I	Enable input. Switch on at Low level. (BD2042AFJ) Low level input < 0.8V Switch On at High level. (BD2052AFJ) High level input > 2.0V. .
5, 8	/OC	O	Error flag output. Low at over current, thermal shutdown. Open drain output.
6, 7	OUT	O	Switch output.

● Absolute Maximum Ratings

◎BD651xF Series

Parameter	Symbol	Ratings	Unit
Input voltage	V _{DD}	-0.3 to 6.0	V
CTRL voltage	V _{CTRL}	-0.3 to V _{DD} +0.3	V
Flag voltage	V _{FLAG}	-0.3 to 6.0	V
Output voltage	V _{OUT}	-0.3 to V _{DD} +0.3 (BD6512F/ BD6513F)	V
		-0.3 to 6.0 (BD6516F/ BD6517F)	V
Storage temperature	T _{STG}	-55 to 150	°C
Power dissipation *1	P _d	560 *1	mW

◎BD20xxAFJ Series

Parameter	Symbol	Ratings	Unit
Input voltage	V _{IN}	-0.3 to 6.0	V
EN,/EN voltage	V _{EN} , V _{/EN}	-0.3 to 6.0	V
/OC voltage	V _{/OC}	-0.3 to 6.0	V
/OC current	I _{S/OC}	10	mA
OUT voltage	V _{OUT}	-0.3 to 6.0	V
Storage temperature	T _{STG}	-55 to 150	°C
Power dissipation *1	P _d	560*1	mW

*1 This value decreases by 4.48mW/°C above Ta=25°C.

● Recommended Operation Ratings

◎BD651xF Series

Parameter	Symbol	Ratings	Unit
Input voltage	V _{DD}	3.0 to 5.5	V
Operation temperature	T _{OPR}	-25 to 85	°C
Continuous output current	I _{LO}	0 to 500	mA

◎BD20xxAFJ Series

Parameter	Symbol	Ratings	Unit
Input voltage	V _{IN}	2.7 to 5.5	V
Operation temperature	T _{OPR}	-40 to 85	°C
Continuous output current	I _{LO}	0 to 500	mA

●Electrical Characteristics

©BD6512F/BD6513F($V_{DD}=5V$, $T_a=25^{\circ}C$, unless otherwise specified.)

Parameter	Symbol	Limits			Unit	Condition
		Min.	Typ.	Max.		
Operating current	I _{DD}	-	85	120	μA	V _{CTRL} =5V(BD6512F), 0V(BD6513F) OUT=OPEN
		-	0.01	2	μA	V _{CTRL} =0V(BD6512F), 5V(BD6513F) OUT=OPEN
Control input voltage	V _{CTRL}	-	-	0.7	V	CTRL Low Level Input
		2.5	-	-	V	CTRL High Level Input
Control input current	I _{CTRL}	-1	0.01	1	μA	V _{CTRL} =0V or 5V
On resistance	R _{ON}	-	100	130	m Ω	V _{DD} =5V, I _{OUT} =500mA
		-	120	160	m Ω	V _{DD} =3.3V, I _{OUT} =500mA
Turn on delay	T _{RD}	100	600	2000	μs	R _L =10 Ω
Turn on rise time	T _R	200	1500	6000	μs	R _L =10 Ω
Turn off delay	T _{FD}	-	3	20	μs	R _L =10 Ω
Turn off fall time	T _F	-	1	20	μs	R _L =10 Ω
UVLO threshold voltage	V _{UVLOH}	2.3	2.5	2.7	V	V _{DD} increasing
	V _{UVLOL}	2.1	2.3	2.5	V	V _{DD} decreasing
Thermal shutdown threshold	T _{TS}	-	135	-	$^{\circ}C$	
Flag output resistance	R _{FLAG}	-	16	40	Ω	I _{FLAG} =5mA
Flag off current	I _{FLAG}	-	0.01	1	μA	
Current limit threshold	I _{THLIM}	1.25	1.65	2.20	A	
Over current limit level	I _{LIM}	0.6	1.1	1.6	A	

©BD6516F/BD6517F ($V_{DD}=5V$, $T_a=25^{\circ}C$, unless otherwise specified.)

Parameter	Symbol	Limits			Unit	Condition
		Min.	Typ.	Max.		
Current consumption	I _{DD}	-	100	140	μA	V _{CTRL} =5V(BD6516F), 0V(BD6517F) OUT=OPEN
		-	0.01	2	μA	V _{CTRL} =0V(BD6516F), 5V(BD6517F) OUT=OPEN
CTRL input voltage	V _{CTRL}	-	-	0.7	V	Low level input voltage
		2.5	-	-	V	High level input voltage
CTRL input current	I _{CTRL}	-1	0.01	1	μA	V _{CTRL} =0V or 5V
FLAG output resistance	R _{FLAG}	-	250	450	Ω	I _{FLAG} =1mA
FLAG output leak current	I _{FLAG}	-	0.01	1	μA	V _{FLAG} =5V
FLAG output delay	T _{DFL}	-	1	4	ms	
ON resistance	R _{ON}	-	110	150	m Ω	V _{DD} =5V, I _{OUT} =500mA
		-	140	180	m Ω	V _{DD} =3.3V, I _{OUT} =500mA
Over-current Threshold	I _{TH}	1.2	1.65	2.5	A	
Short circuit output current	I _{SC}	1.2	1.65	2.2	A	V _{OUT} =0V
Output leak current	I _{LEAK}	-	-	10	μA	V _{CTRL} =0V(BD6516F), 5V(BD6517F)
Thermal shutdown threshold	T _{TS}	-	135	-	$^{\circ}C$	At T _j increase
Output rise time	T _{ON1}	100	1300	4000	μs	R _L =10 Ω
Output turn on delay time	T _{ON2}	200	1500	6000	μs	R _L =10 Ω
Output fall time	T _{OFF1}	-	1	20	μs	R _L =10 Ω
Output turn off delay time	T _{OFF2}	-	3	20	μs	R _L =10 Ω

©BD20xxAFJ Series ($V_{DD} = 5V$, $T_a = 25^\circ C$, unless otherwise specified.)

Parameter	Symbol	Limits			Unit	Condition
		Min.	Typ.	Max.		
Operating Current	I_{DD}	-	110	140	μA	$V_{/EN} = 0V$, OUT = OPEN (BD2042AFJ) $V_{EN} = 5V$, OUT = OPEN (BD2052AFJ)
Standby Current	I_{STB}	-	0.01	1	μA	$V_{/EN} = 5V$, OUT = OPEN (BD2042AFJ) $V_{EN} = 0V$, OUT = OPEN (BD2052AFJ)
/EN input voltage	$V_{/EN,EN}$	2.0	-	-	V	High input
		-	-	0.8	V	Low input
		-	-	0.4	V	Low input $2.7V \leq V_{IN} \leq 4.5V$
/EN input current	$I_{/EN,EN}$	-1.0	0.01	1.0	μA	$V_{/EN,EN} = 0V$ or $V_{/EN,EN} = 5V$
/OC output LOW voltage	$V_{/OC}$	-	-	0.5	V	$I_{/OC} = 5mA$
/OC output leak current	$I_{L/OC}$	-	0.01	1	μA	$V_{/OC} = 5V$
ON resistance	R_{ON}	-	100	130	$m\Omega$	$I_{OUT} = 500mA$
Over Current Threshold	I_{TH}	0.7	1.0	1.8	A	
Output current at short	I_{SC}	0.7	1.0	1.3	A	$V_{IN} = 5V$, $V_{OUT} = 0V$, $C_L = 100\mu F$ (RMS)
Output rise time	T_{ON1}	-	1.8	10	ms	$R_L = 10\Omega$, $C_L = OPEN$
Output turn on time	T_{ON2}	-	2.1	20	ms	
Output fall time	T_{OFF1}	-	1	20	μs	
Output turn off time	T_{OFF2}	-	3	40	μs	
UVLO threshold	V_{TUVH}	2.1	2.3	2.5	V	Increasing V_{IN}
	V_{TUVL}	2.0	2.2	2.4	V	Decreasing V_{IN}

● Measurement Circuit

©BD651xF Series

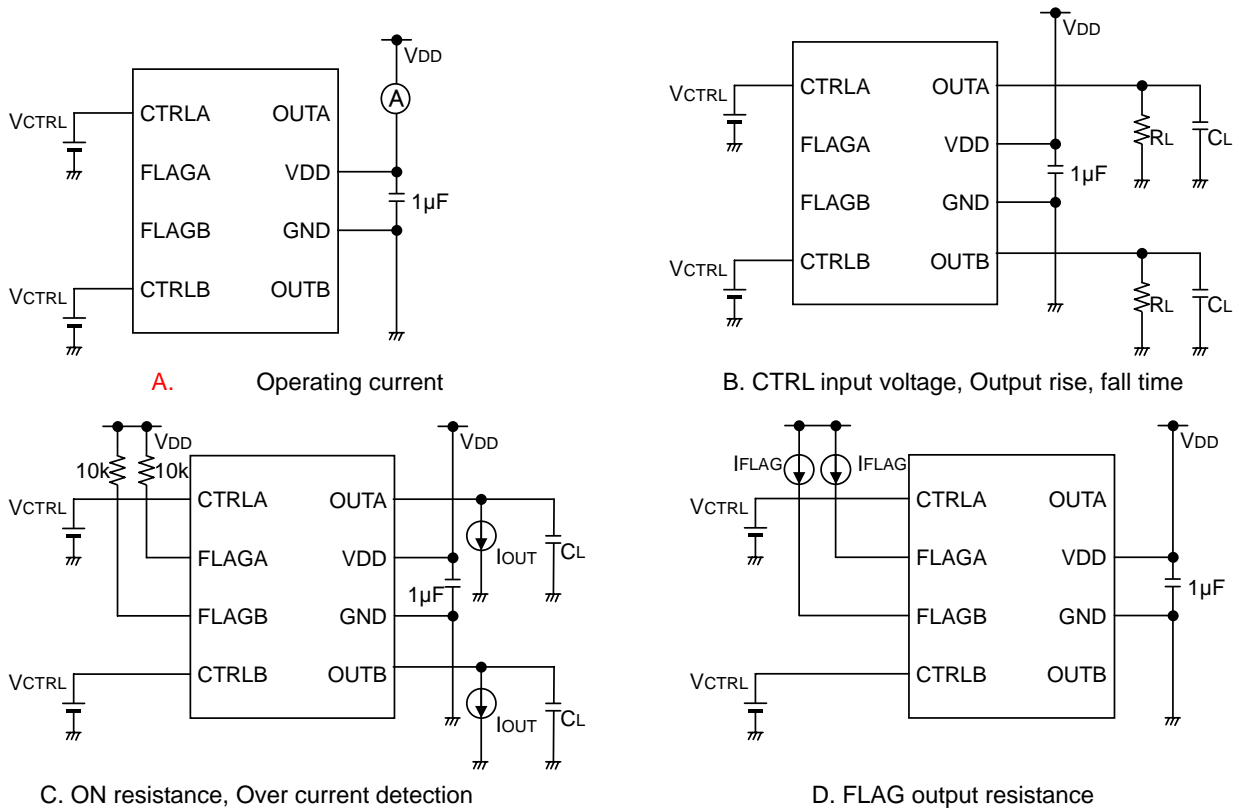

©BD20xxAFJ Series

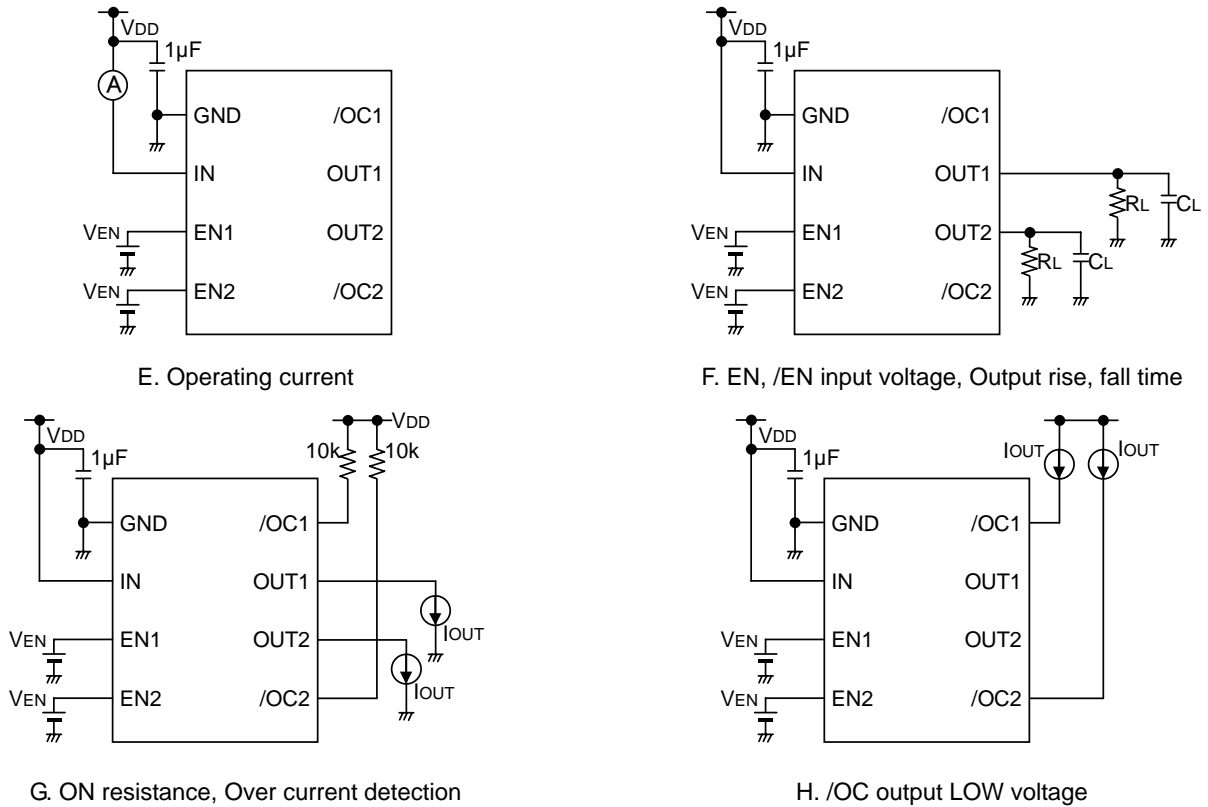
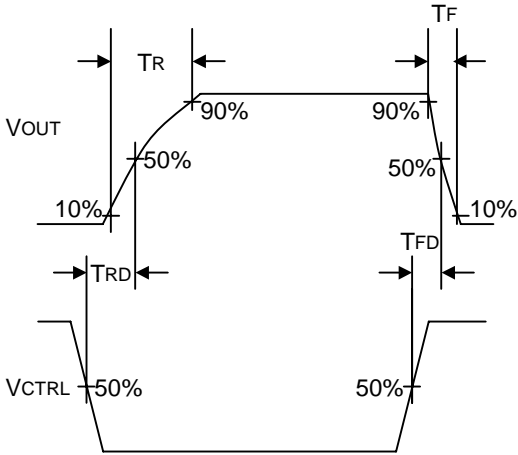

Figure 1. Measurement circuits

●Timing Diagram

©BD6513F



©BD6512F

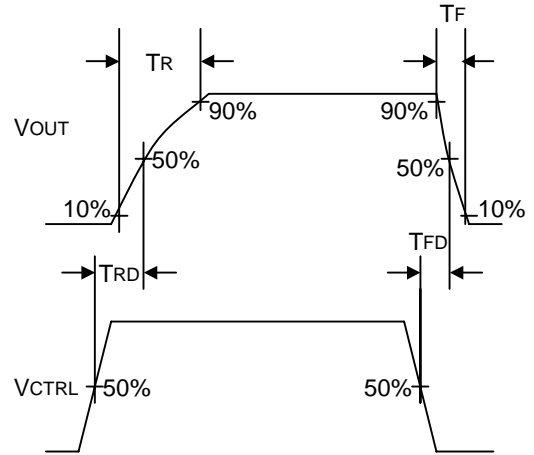

©BD6516F/BD2042AFJ

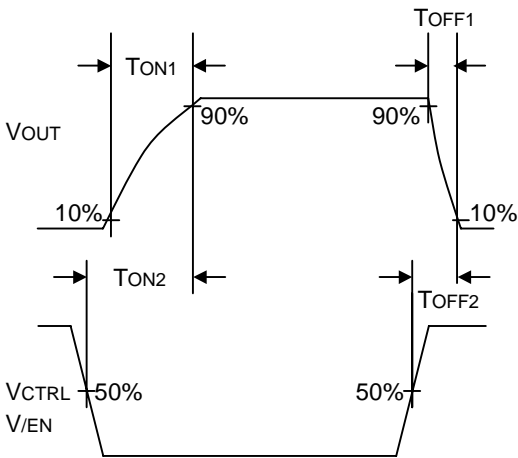

©BD6517F/BD2052AFJ

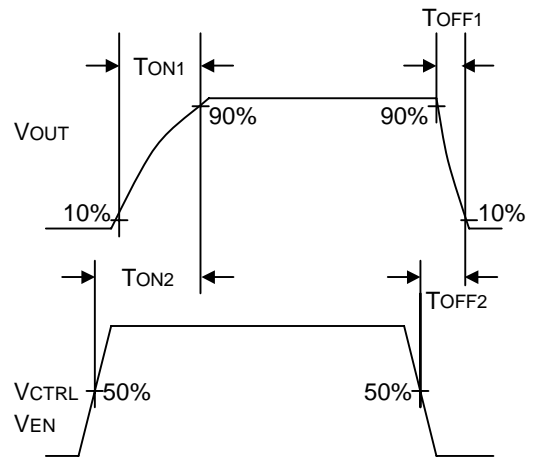

Figure 2. Timing Diagram

● Typical Performance Curves

©BD6512F/ BD6513F

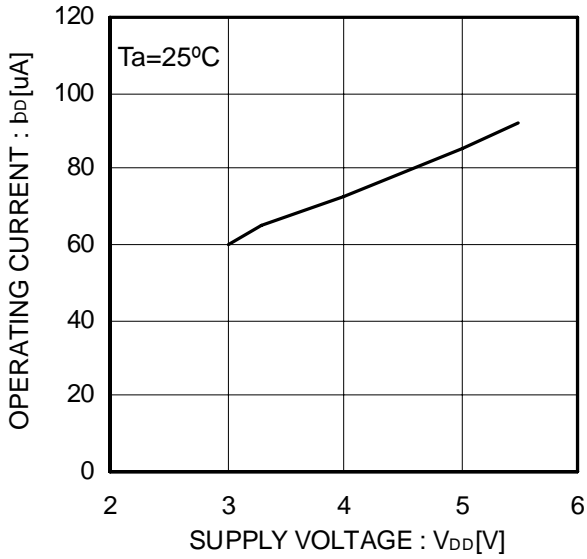

Figure 3. Operating current

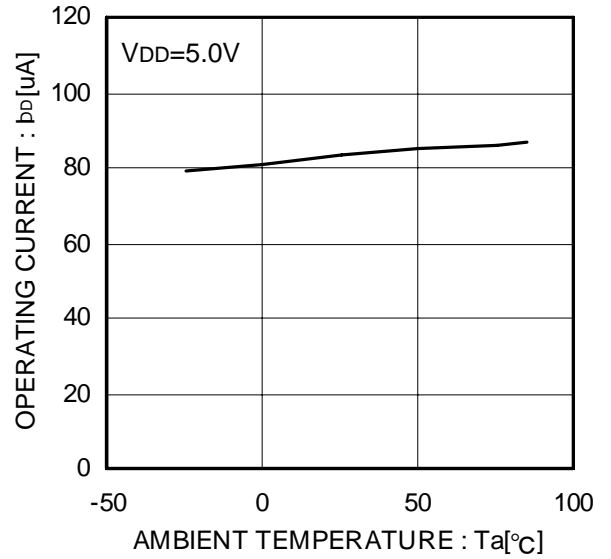

Figure 4. Operating current

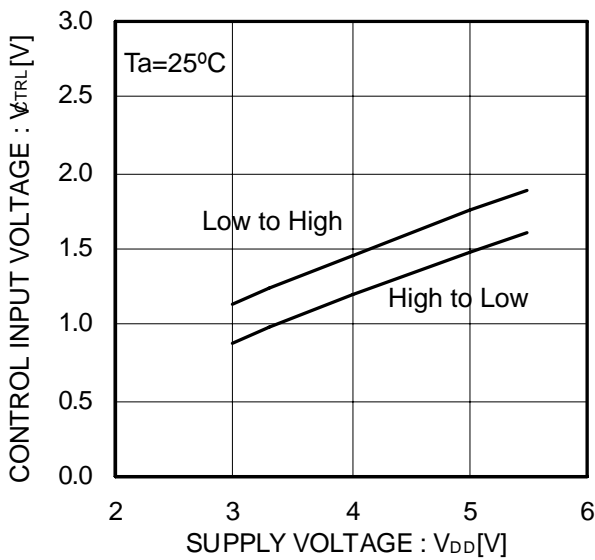

Figure 5. CTRL input voltage

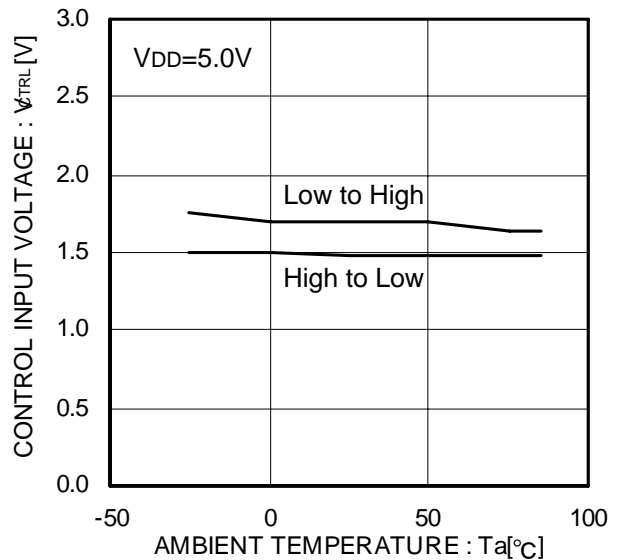

Figure 6. CTRL input voltage

● Typical Performance Curves - continued

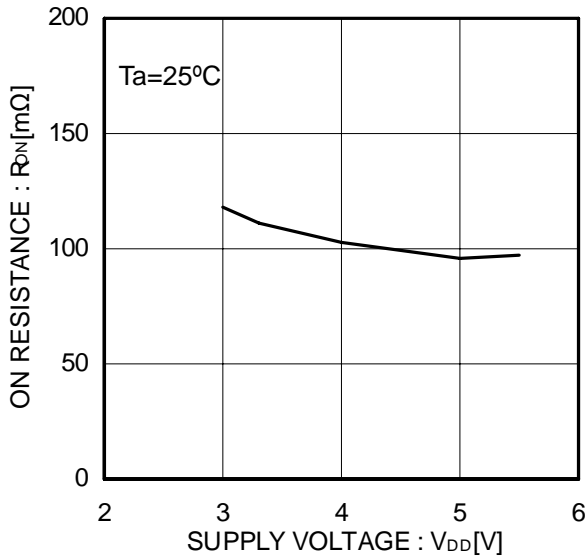

Figure 7. ON resistance

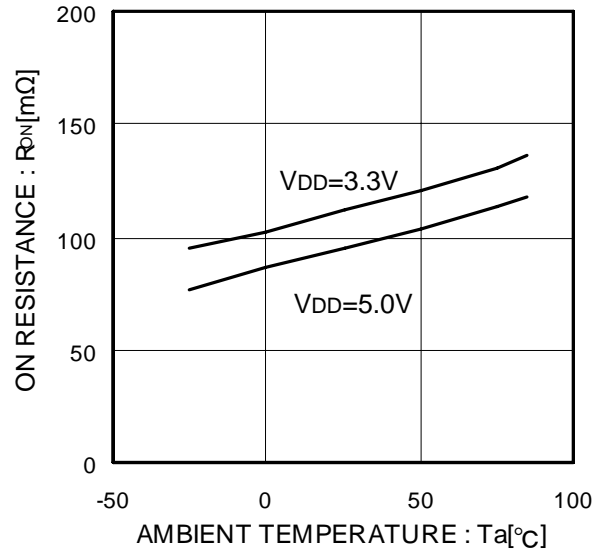

Figure 8. ON resistance

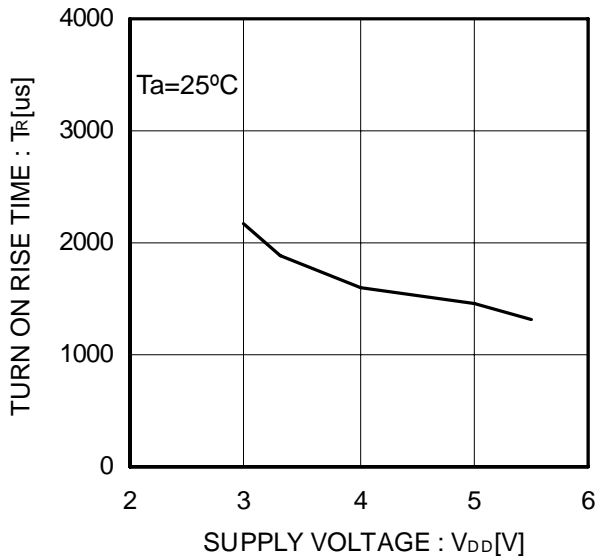

Figure 9. Output rise time

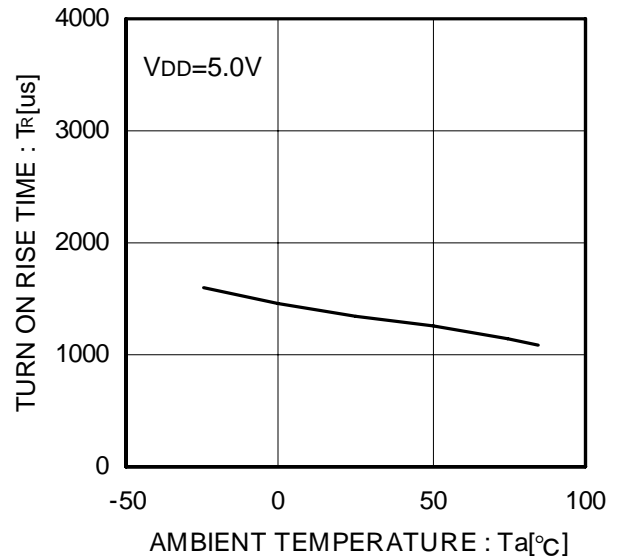

Figure 10. Output rise time

● Typical Performance Curves - continued

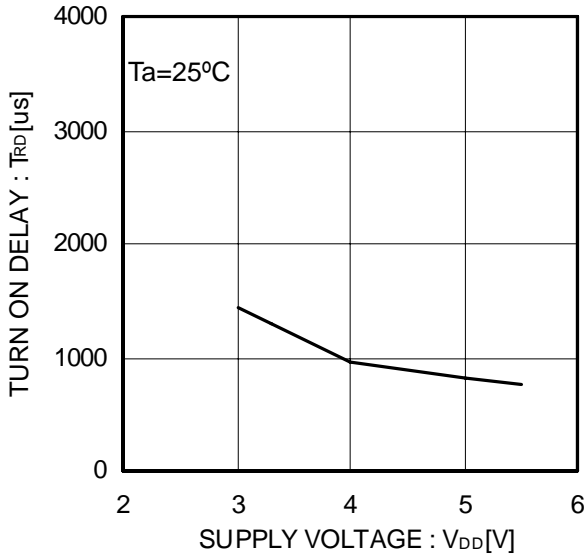

Figure 11. Output rise delay time

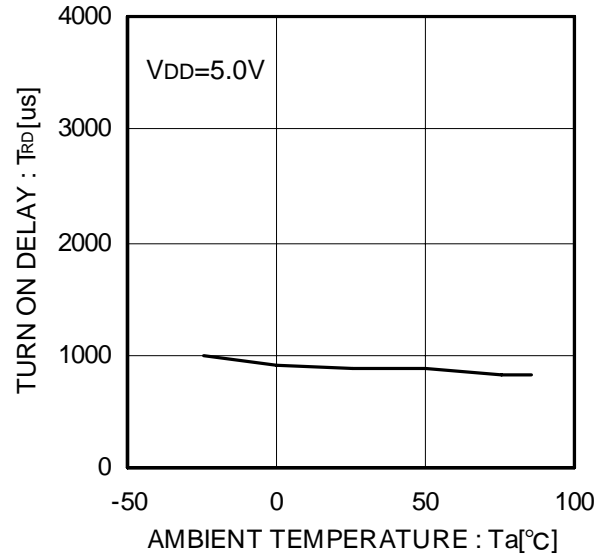

Figure 12. Output rise delay time

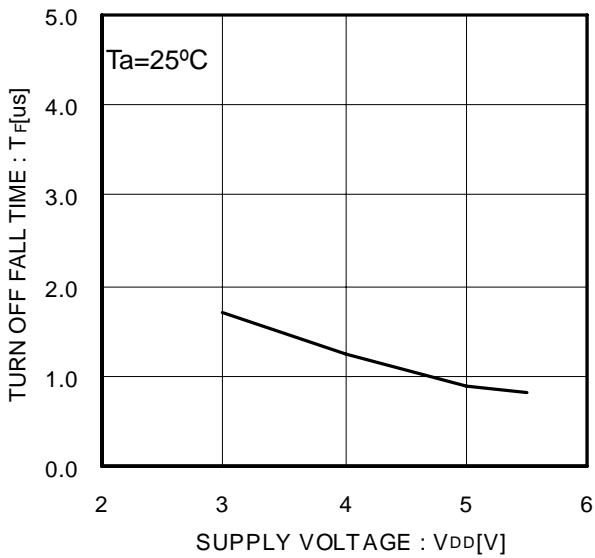

Figure 13. Output fall time

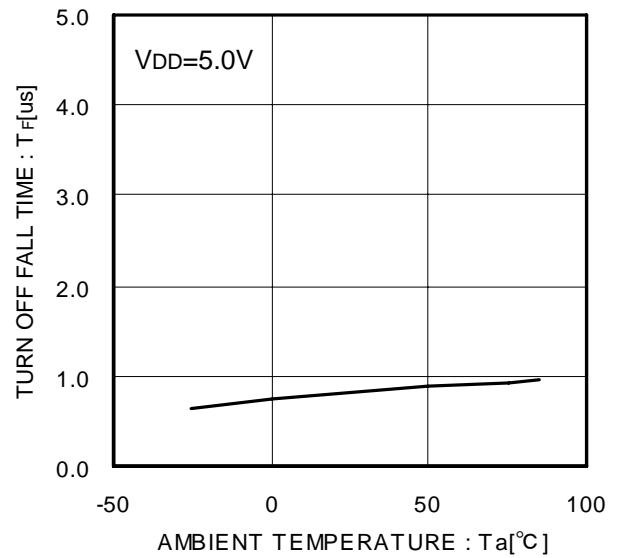

Figure 14. Output fall time

● Typical Performance Curves - continued

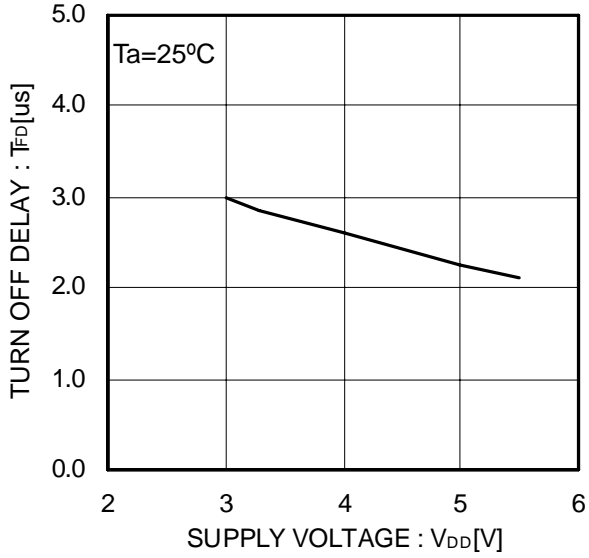

Figure 15. Output fall delay time

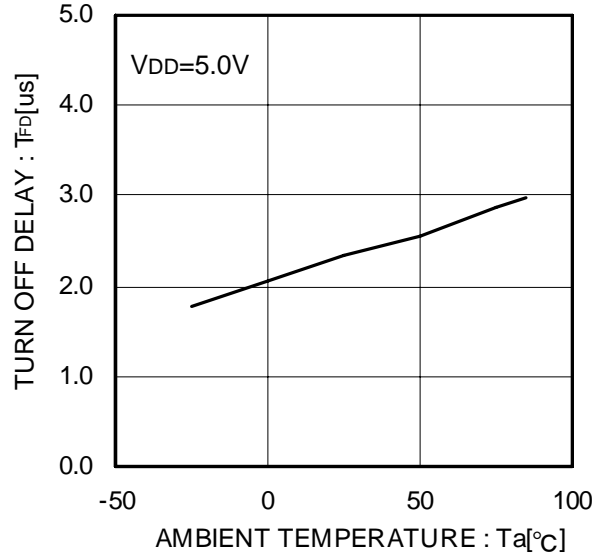

Figure 16. Output fall delay time

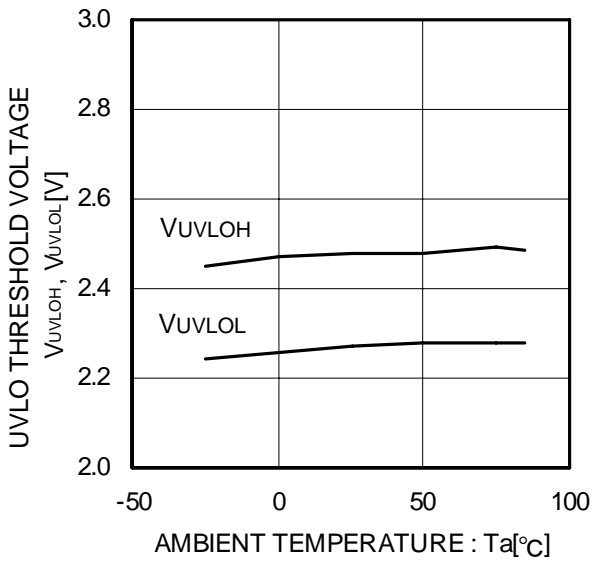

Figure 17. UVLO threshold voltage

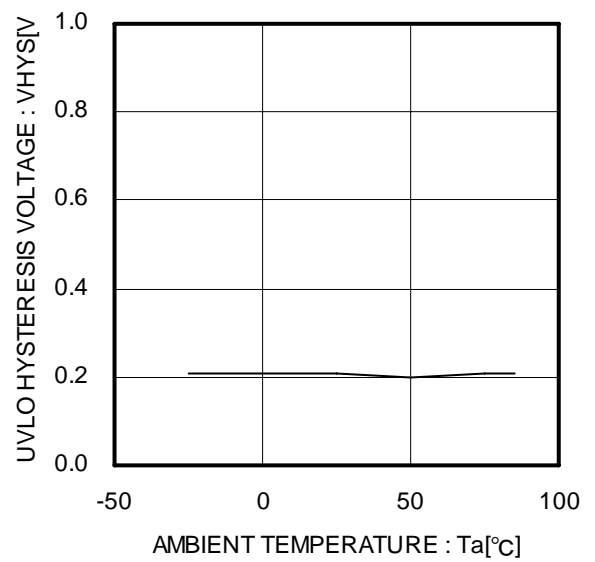

Figure 18. UVLO hysteresis voltage

● Typical Performance Curves - continued

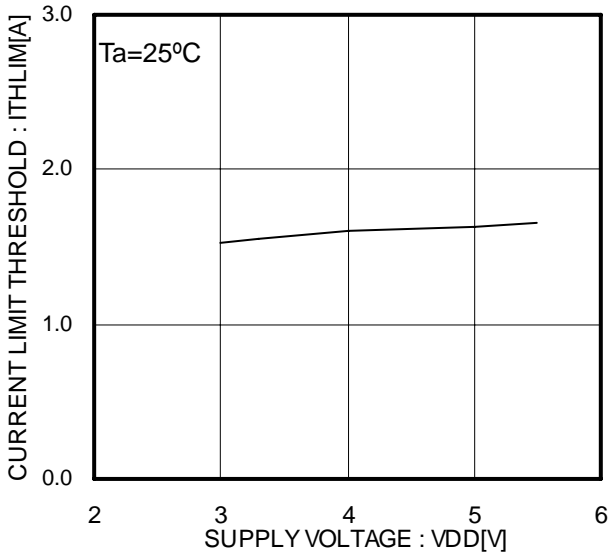

Figure 19. Over current threshold

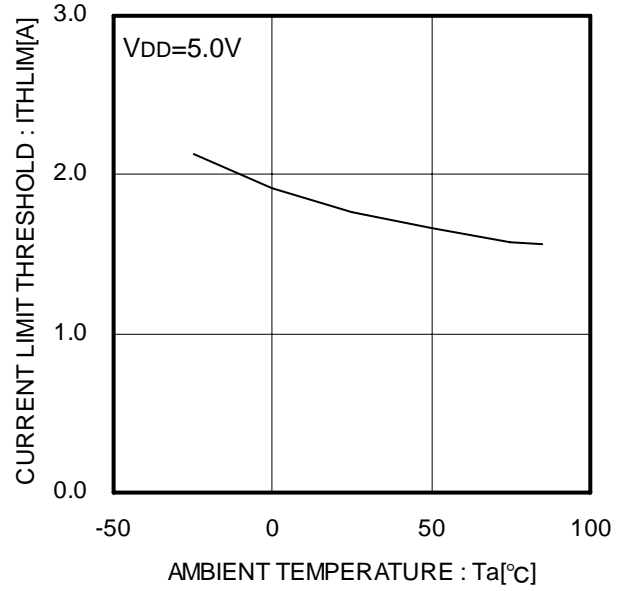

Figure 20. Over current threshold

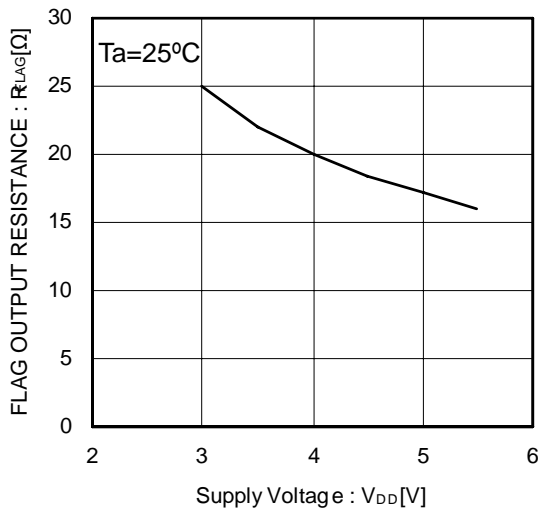

Figure 21. Flag output resistance

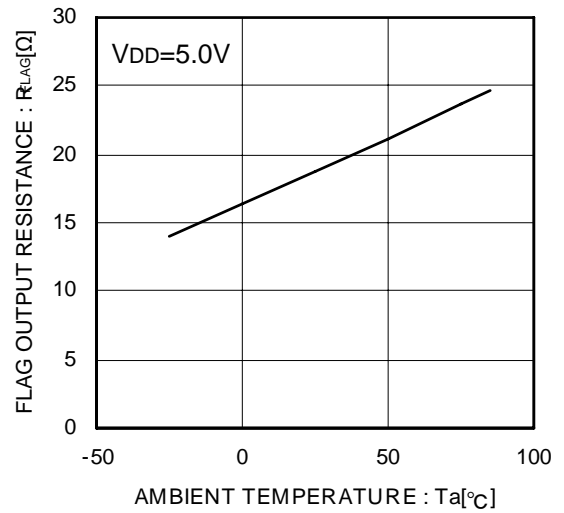

Figure 22. Flag output resistance

● Typical Performance Curves - continued

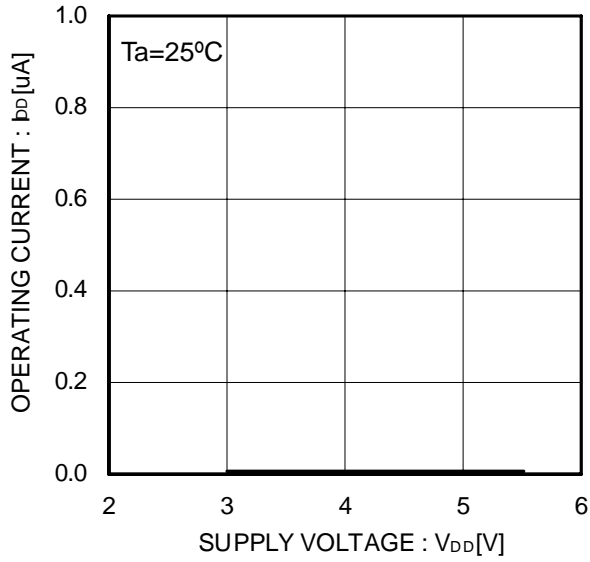

Figure 23. Operating current
CTRL Disable

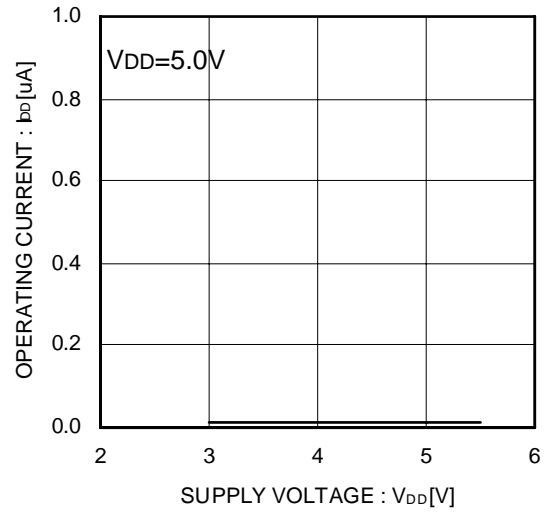

Figure 24. Operating current
CTRL Disable

● Typical Performance Curves – continued

©BD6516F/ BD6517F

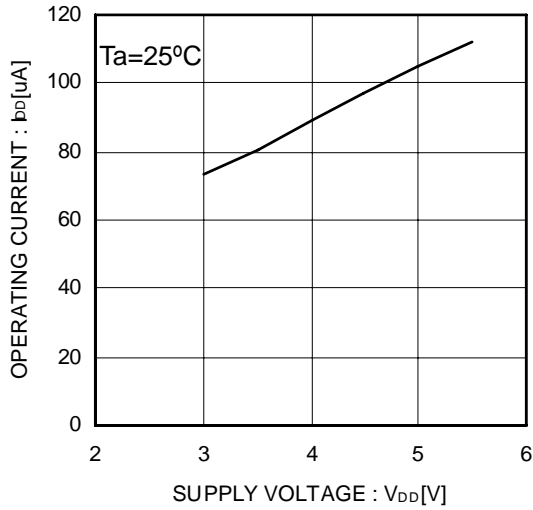

Figure 25. Operating current

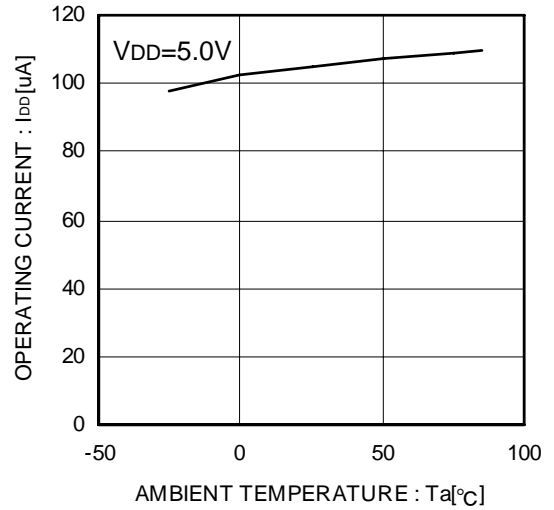

Figure 26. Operating current

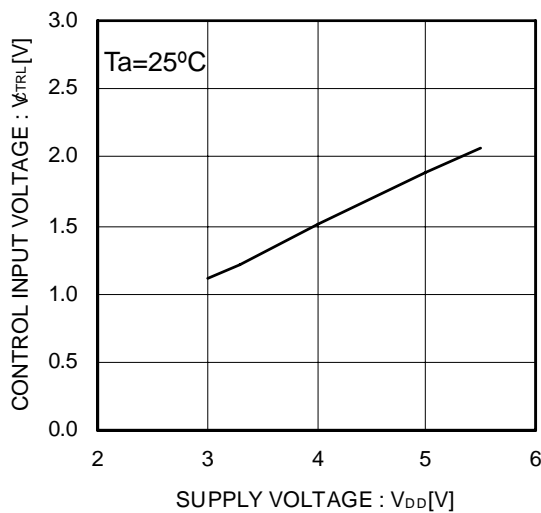

Figure 27. CTRL input voltage (BD6516F)

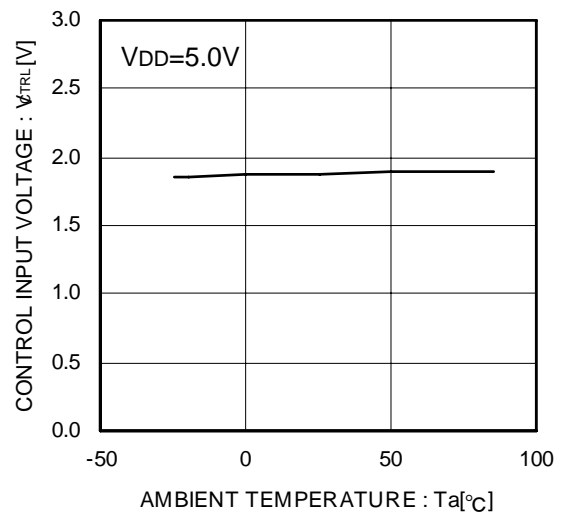

Figure 28. CTRL input voltage (BD6516F)

● Typical Performance Curves - continued

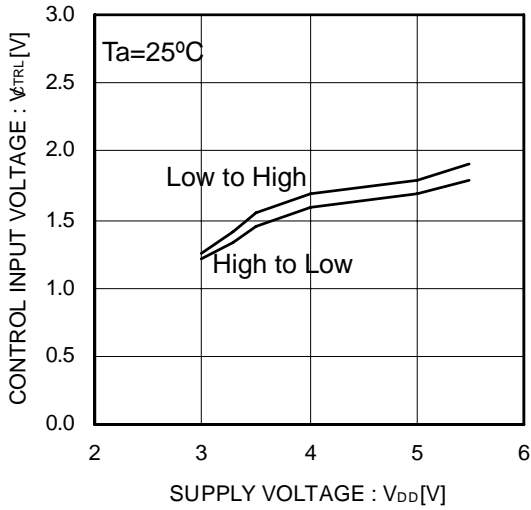

Figure 29. CTRL input voltage (BD6517F)

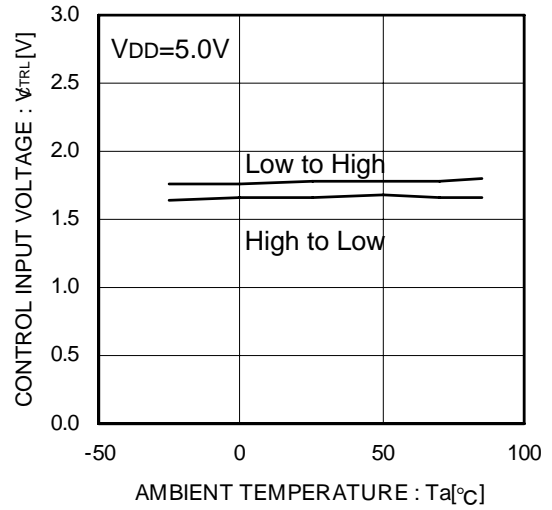

Figure 30. CTRL input voltage (BD6517F)

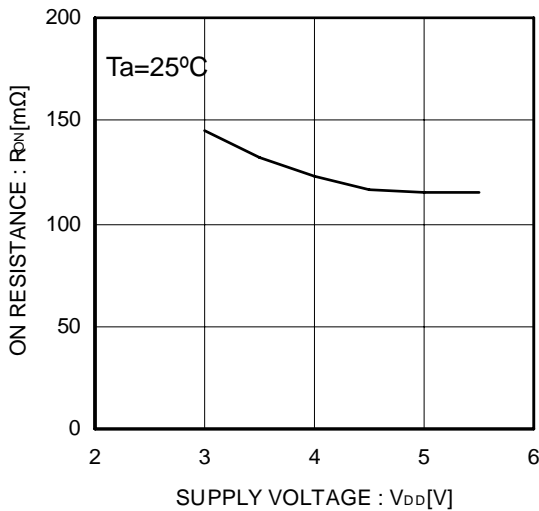

Figure 31. ON resistance

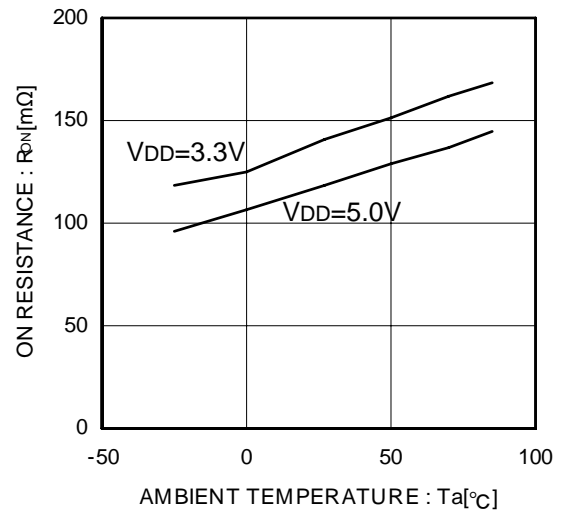

Figure 32. ON resistance

● Typical Performance Curves - continued

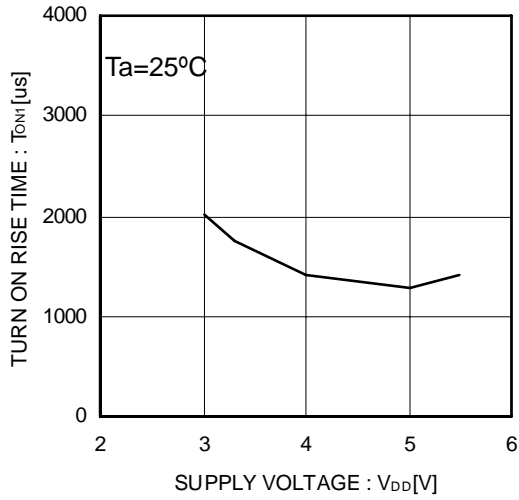

Figure 33. Output rise time

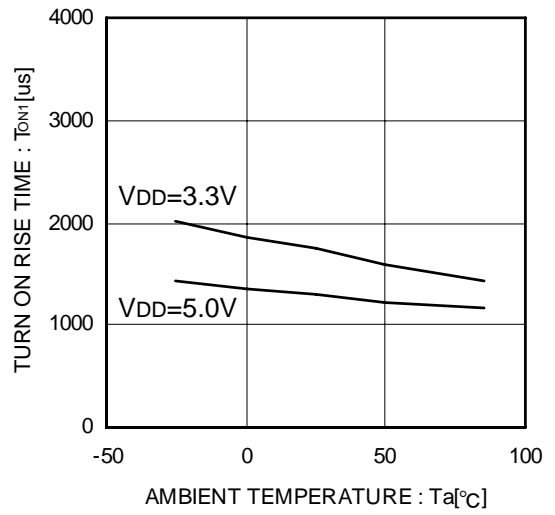

Figure 34. Output rise time

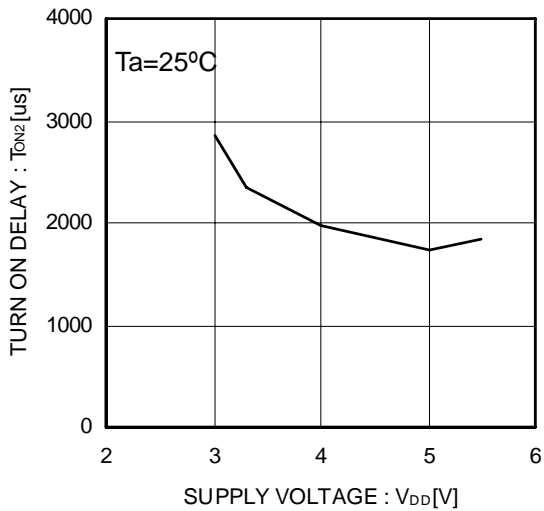

Figure 35. Output rise delay time

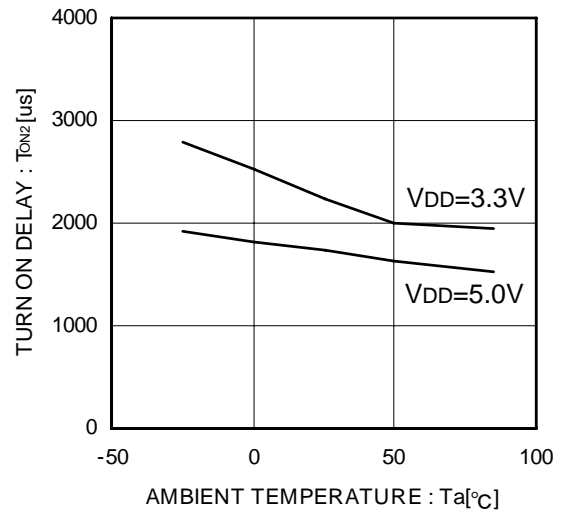

Figure 36. Output rise delay time

● Typical Performance Curves - continued

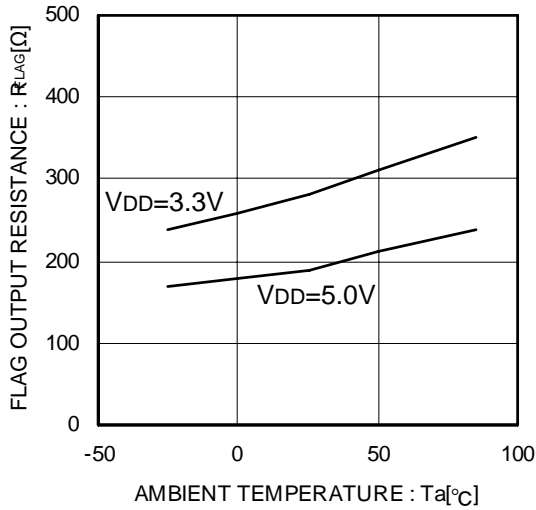

Figure 37. Flag output resistance

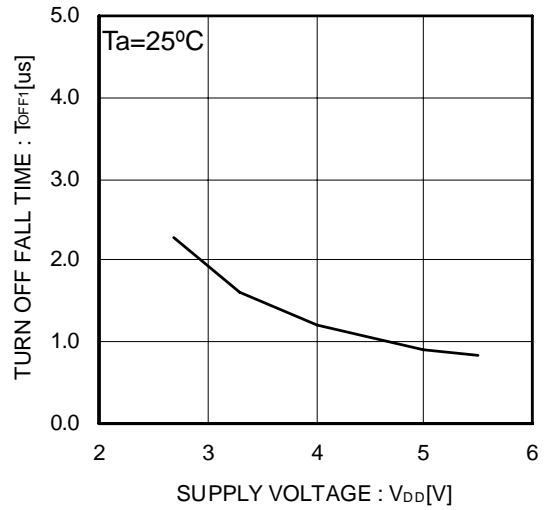

Figure 38. Output fall time

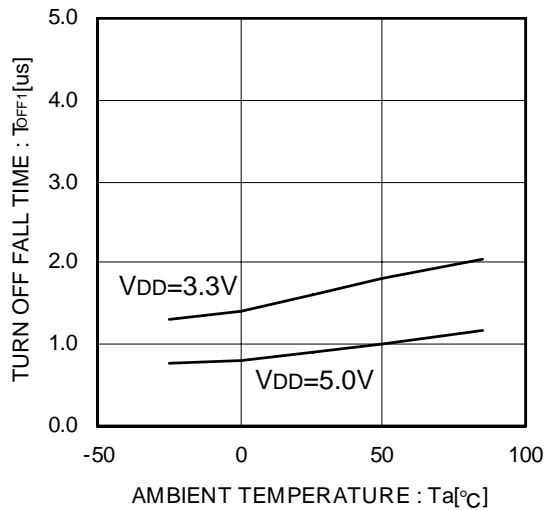

Figure 39. Output fall time

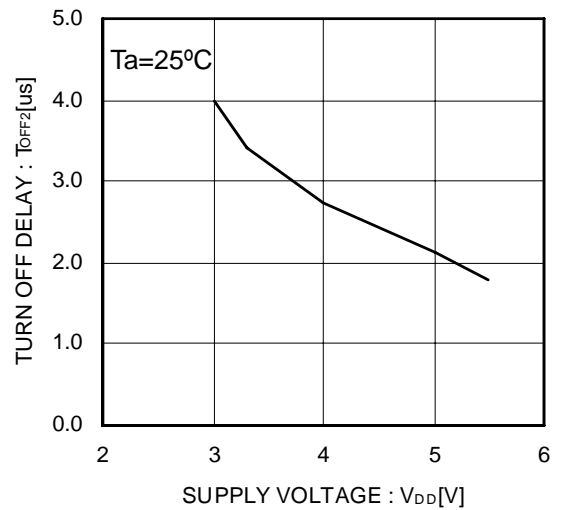

Figure 40. Output fall delay time

● Typical Performance Curves - continued

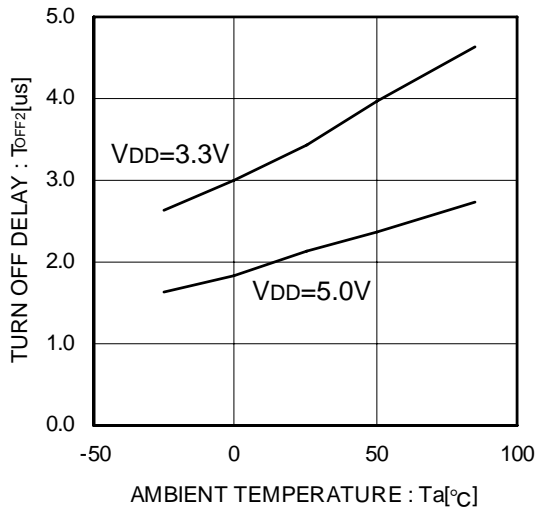

Figure 41. Output fall delay time

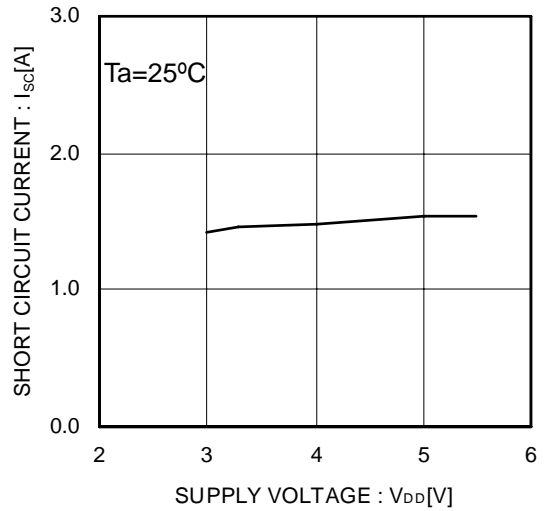

Figure 42. Short-circuit output current

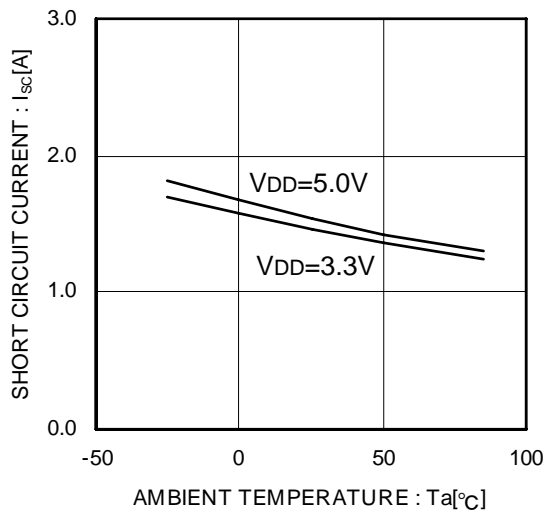

Figure 43. Short-circuit output current

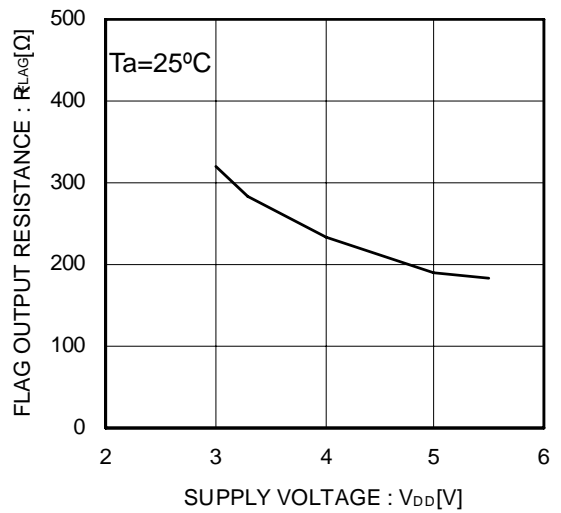

Figure 44. Flag output resistance

● Typical Performance Curves - continued

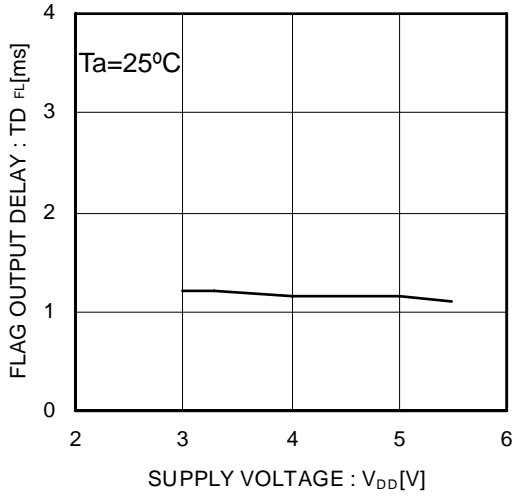

Figure 45. Flag output delay

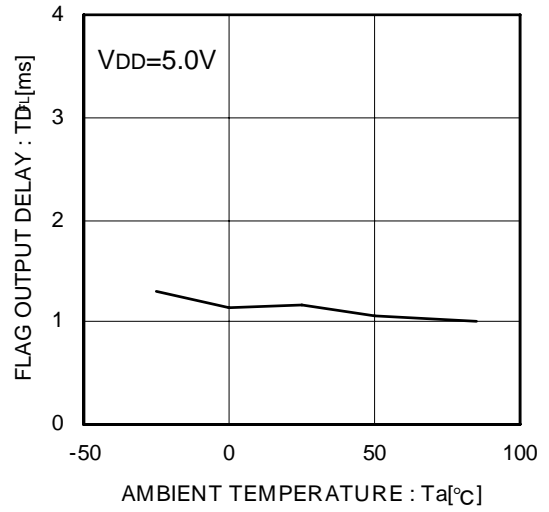

Figure 46. Flag output delay

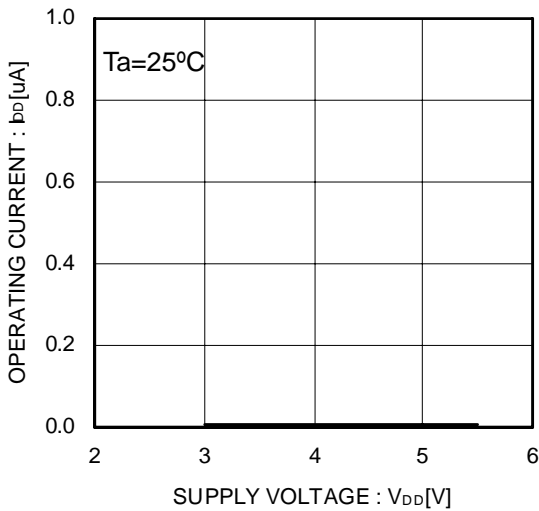

Figure 47. Operating current
CTRL Disable

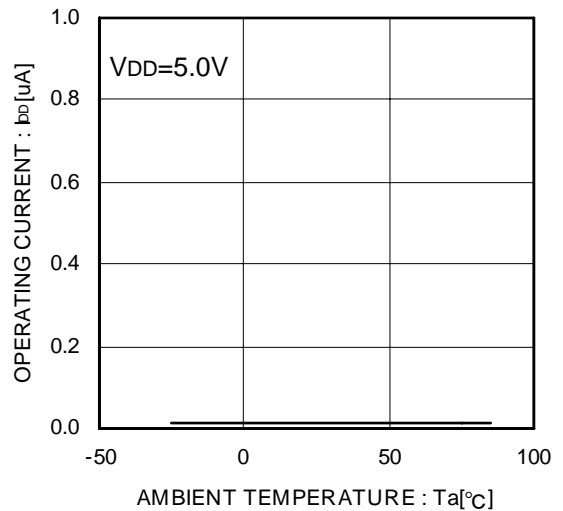

Figure 48. Operating current
CTRL Disable

● Typical Performance Curves – continued

©BD2042AFJ/ BD2052AFJ

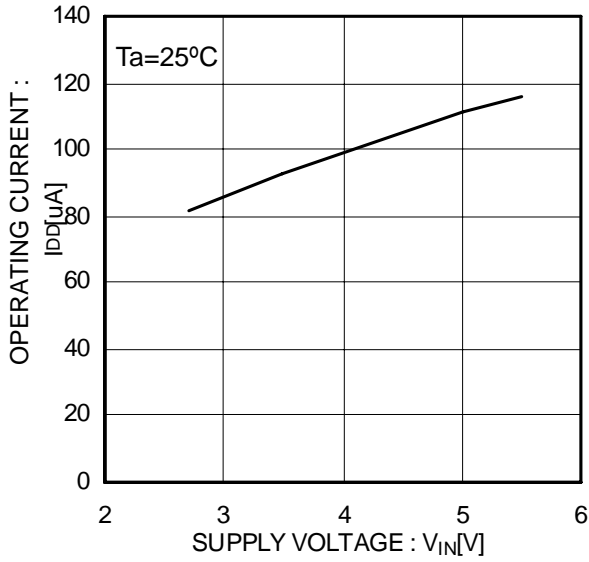

Figure 49. Operating current EN,/EN Enable

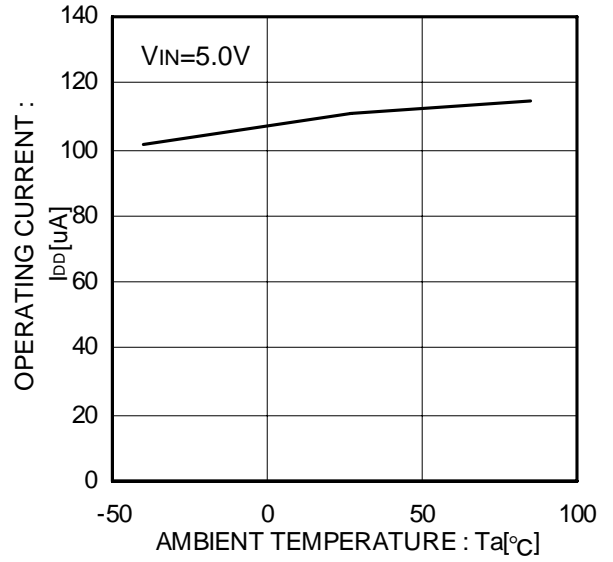

Figure 50. Operating current EN,/EN Enable

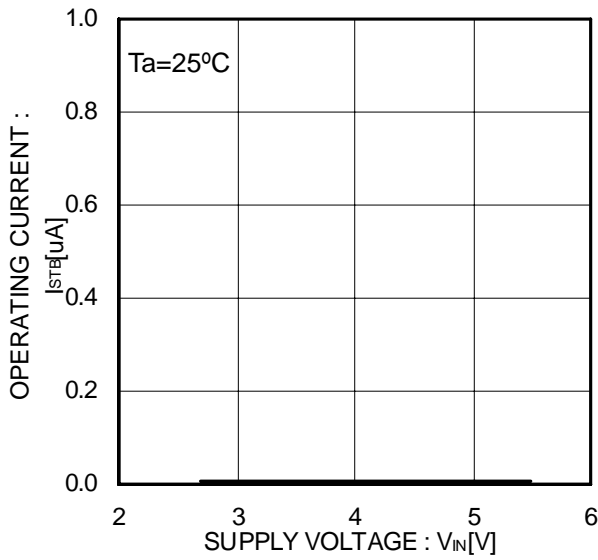

Figure 51. Operating current EN,/EN Disable

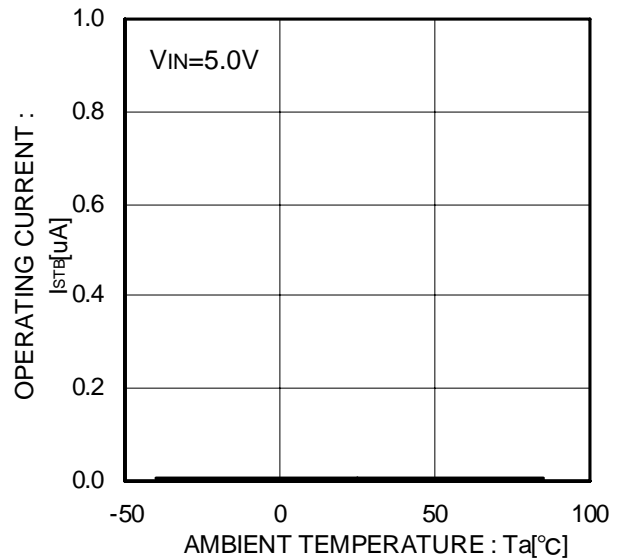

Figure 52. Operating current EN,/EN Disable

● Typical Performance Curves - continued

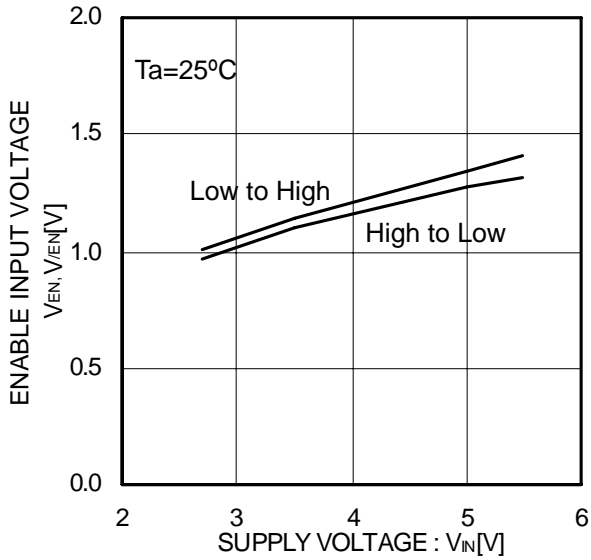

Figure 53. EN,/EN input voltage

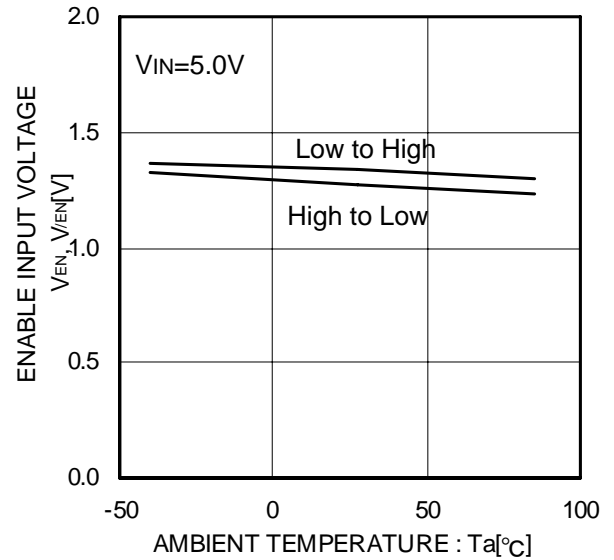

Figure 54. EN,/EN input voltage

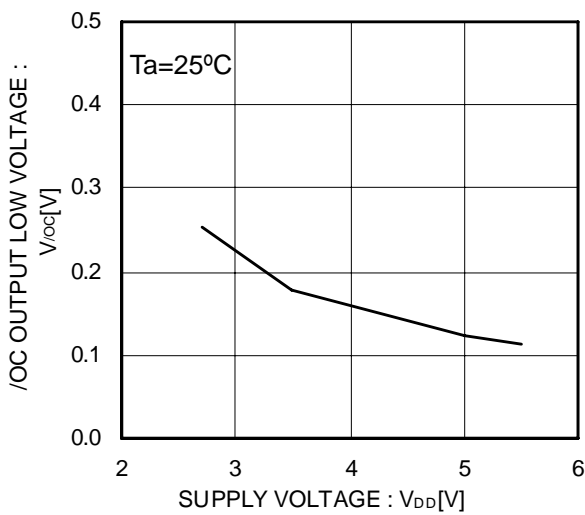

Figure 55. /OC output LOW voltage

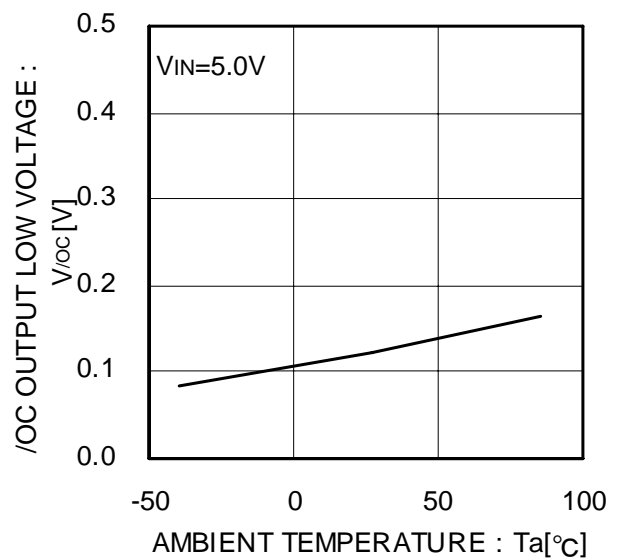

Figure 56. /OC output LOW voltage

● Typical Performance Curves - continued

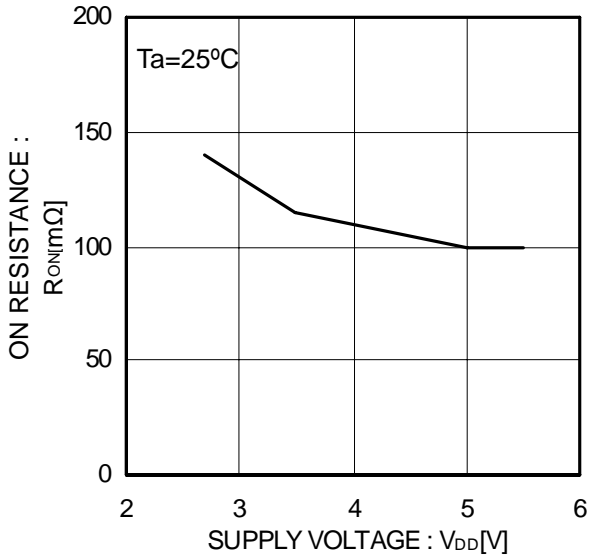

Figure 57. ON resistance

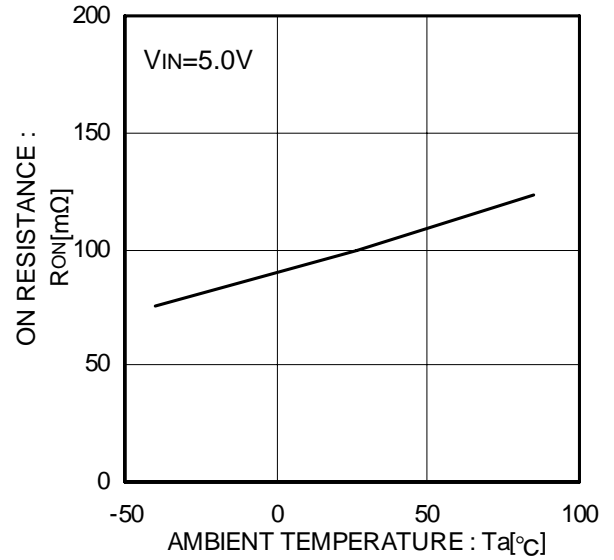

Figure 58. ON resistance

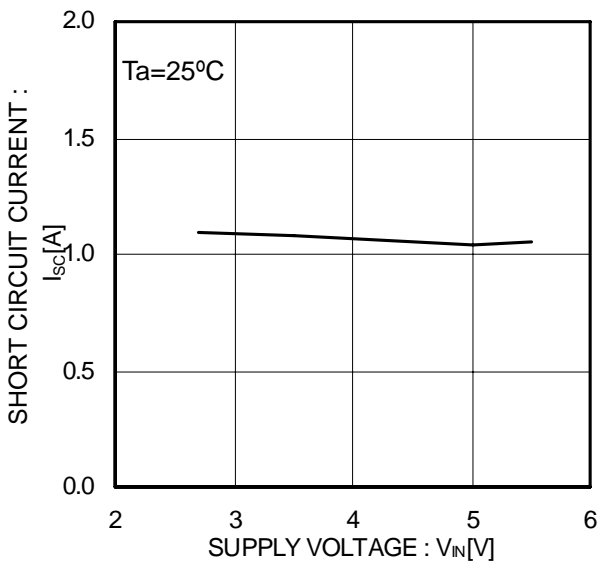

Figure 59. Output current at short-circuit

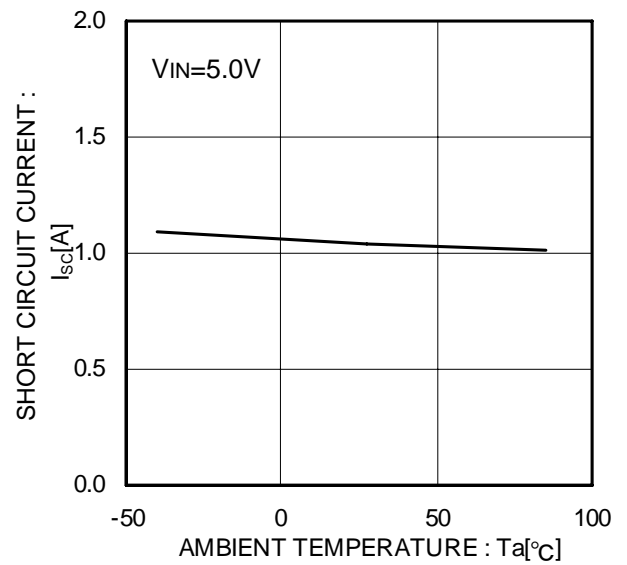

Figure 60. Output current at short-circuit

● Typical Performance Curves - continued

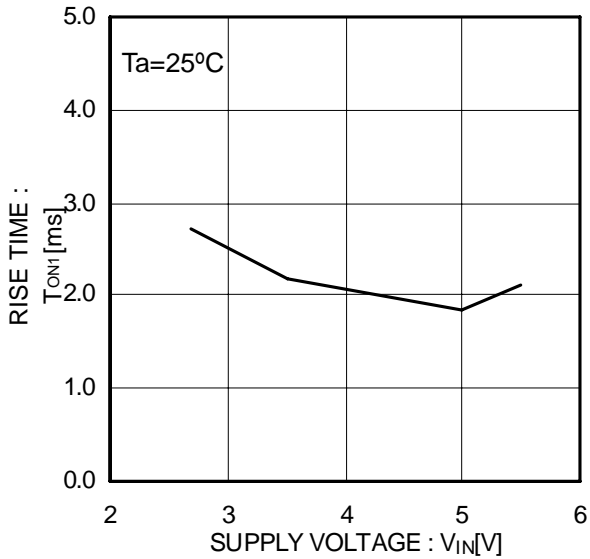

Figure 61. Output rise time

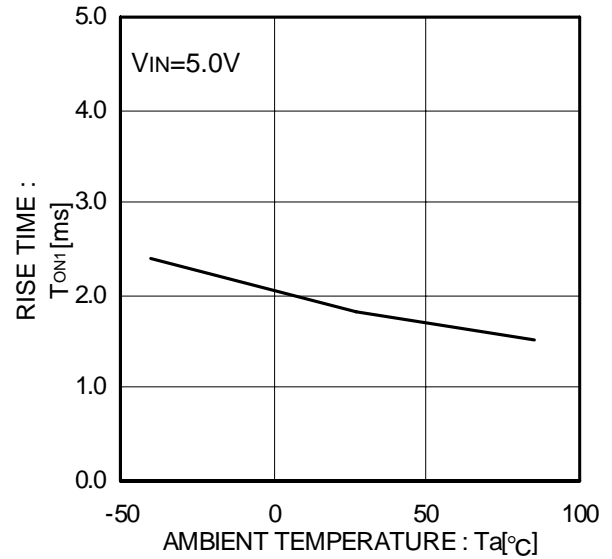

Figure 62. Output rise time

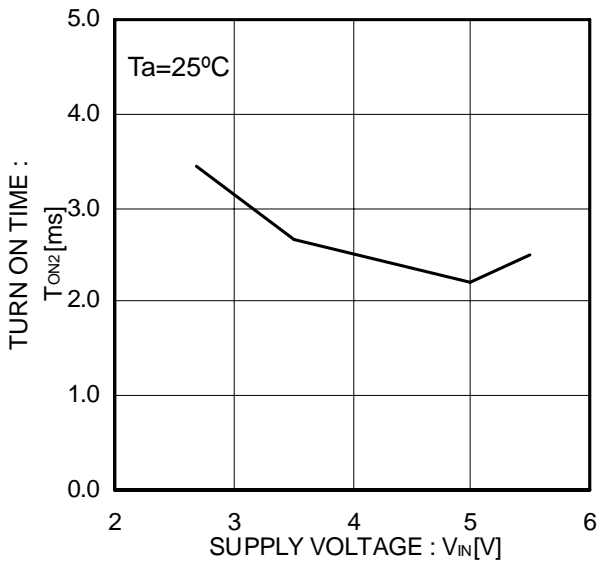

Figure 63. Output turn on time

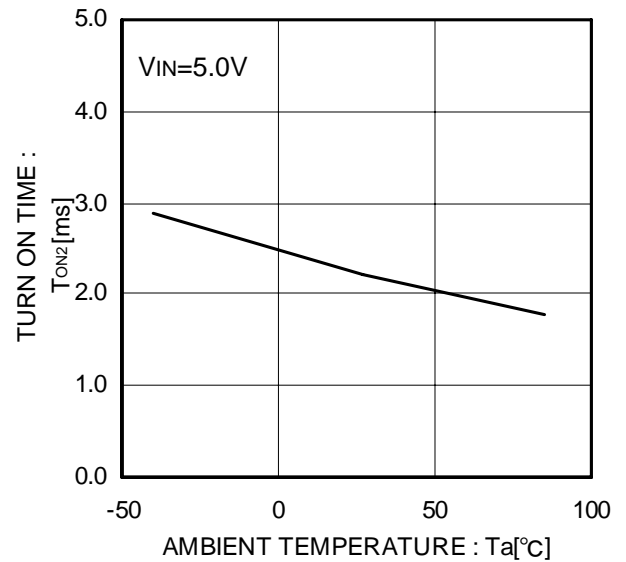

Figure 64. Output turn on time

● Typical Performance Curves - continued

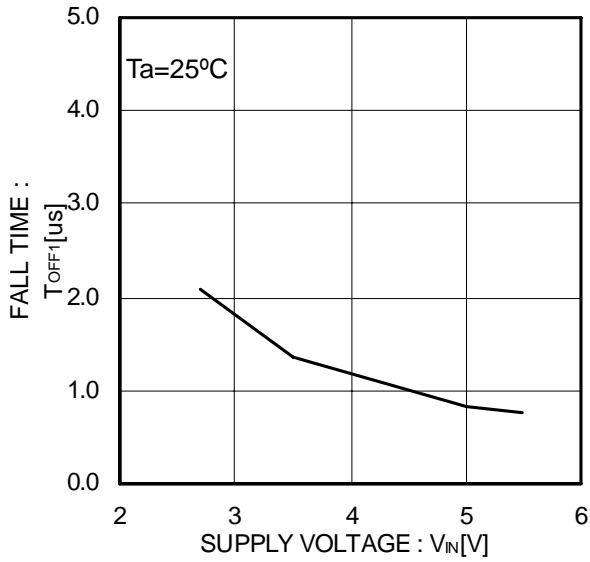

Figure 65. Output fall time

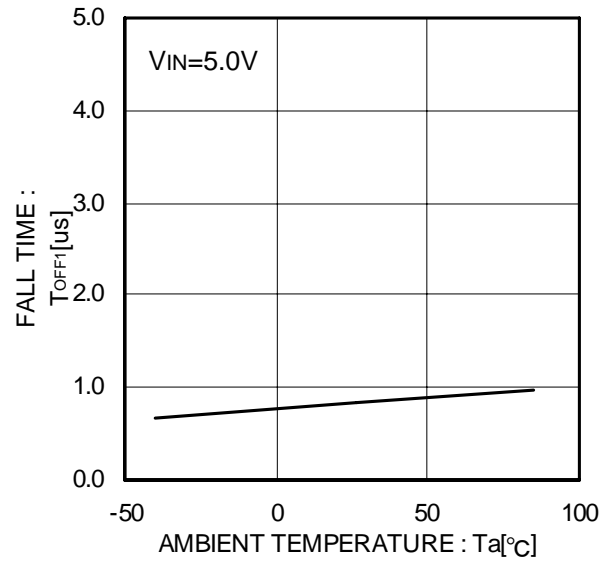

Figure 66. Output fall time

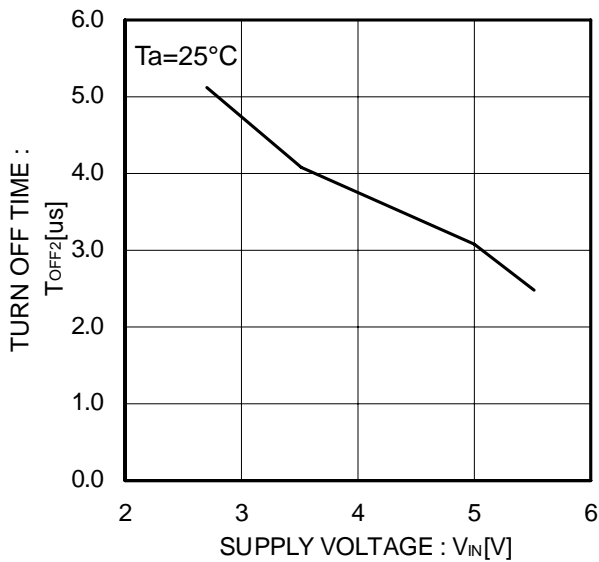

Figure 67. Output turn off time

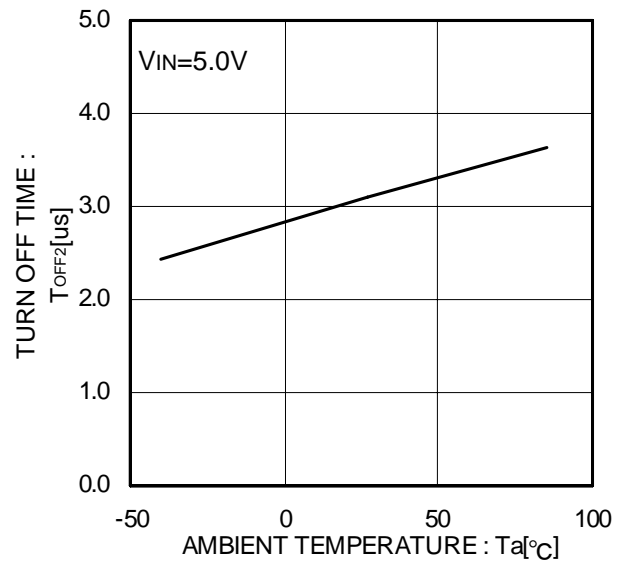

Figure 68. Output turn off time

● Typical Performance Curves - continued

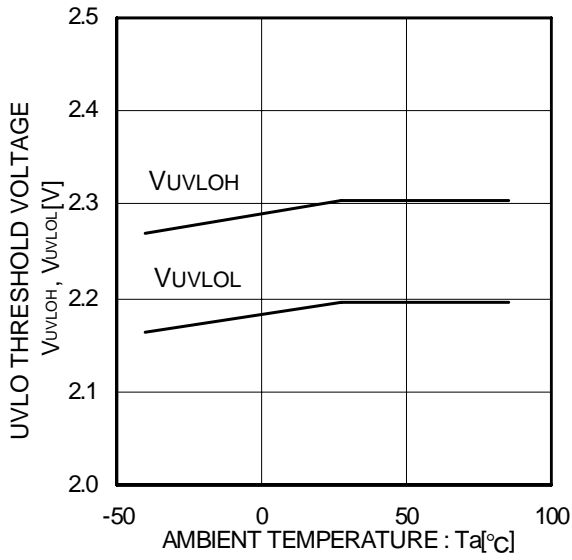

Figure 69. UVLO threshold voltage

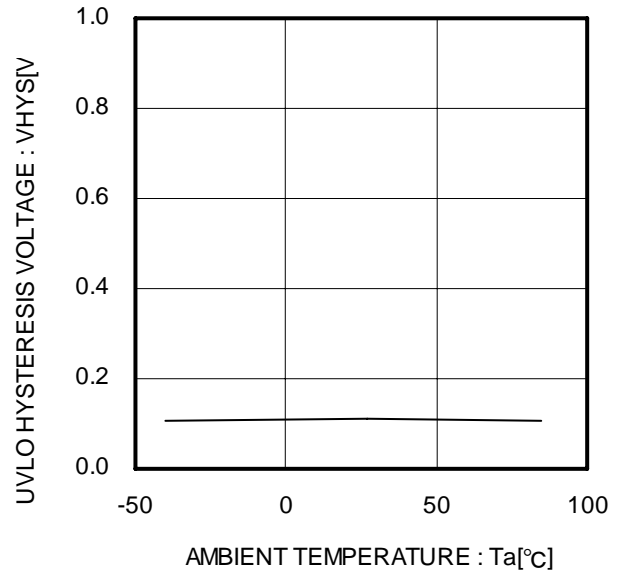

Figure 70. UVLO hysteresis voltage

● Typical Wave Forms

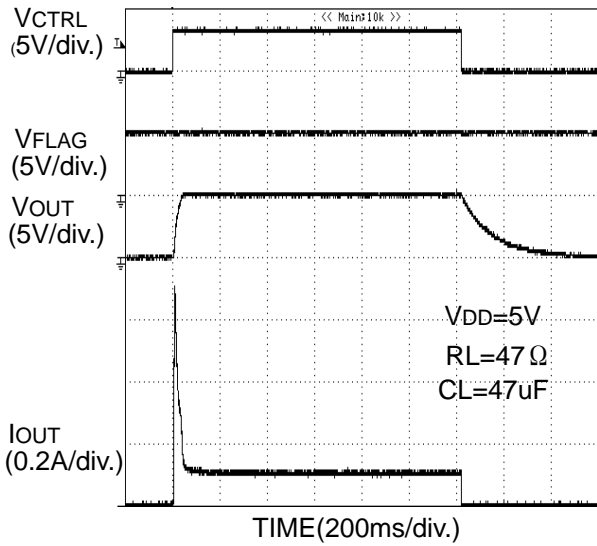

Figure 71. Output rise, fall characteristic (BD6512F)

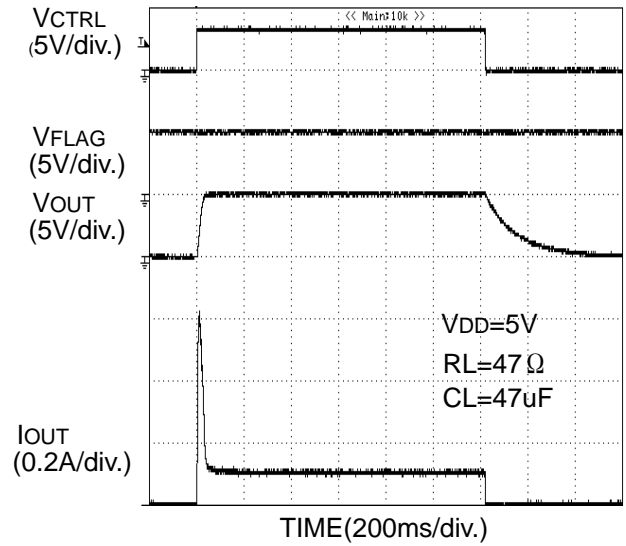

Figure 72. Output rise, fall characteristic (BD6516F)

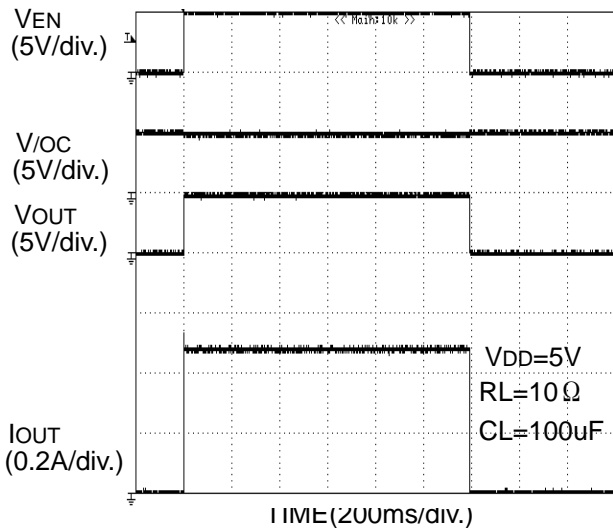

Figure 73. Output rise, fall characteristic (BD2052AFJ)

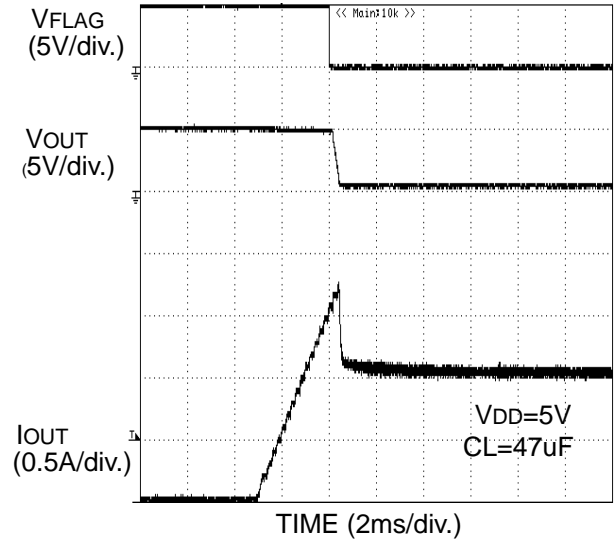

Figure 74. Over Current Load Transient Response (BD6512F)

● Typical Wave Forms - continued

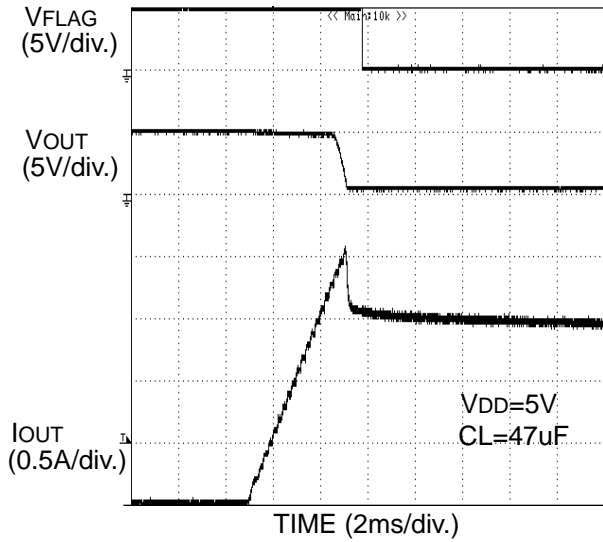

Figure 75. Over Current Load Transient Response (BD6516F)

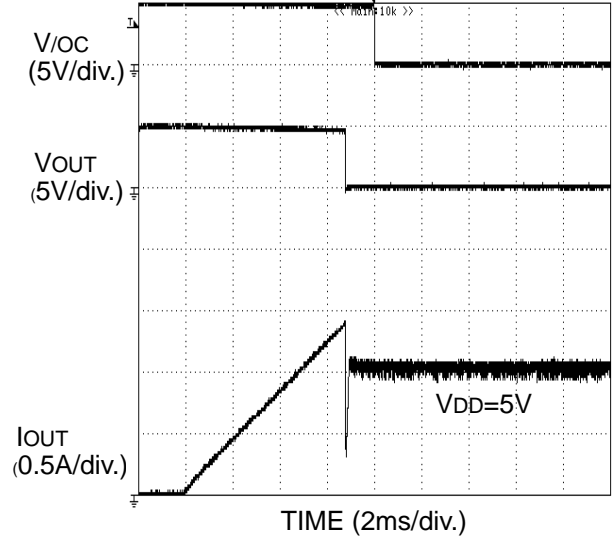

Figure 76. Over Current Load Transient Response (BD2052AFJ)

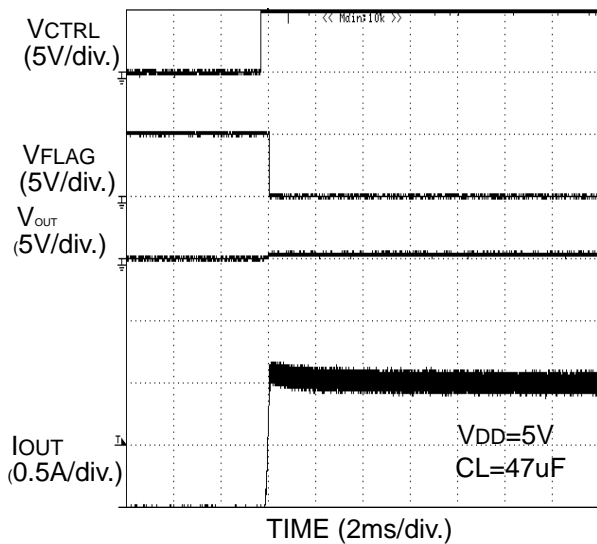

Figure 77. Over Current response Enable to short circuit (BD6512F)

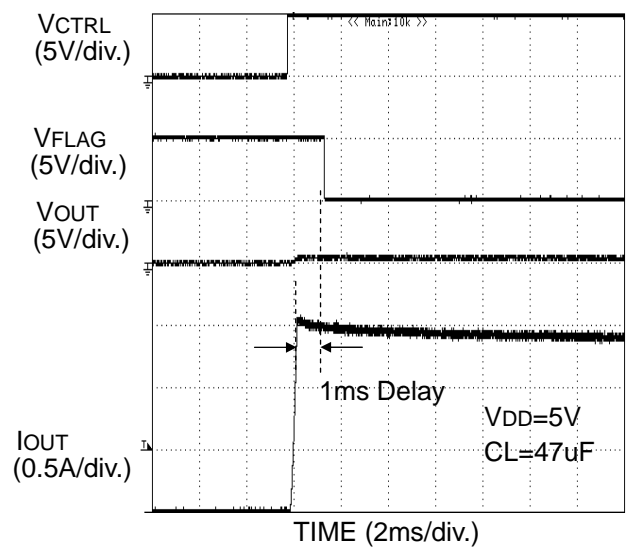

Figure 78. Over current response Enable to short circuit (BD6516F)

● Typical Wave Forms - continued

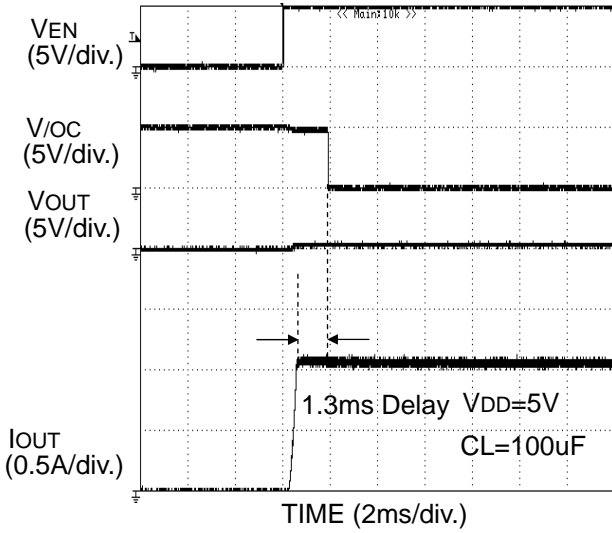

Figure 79. Over current response
Enable to short circuit
(BD2052AFJ)

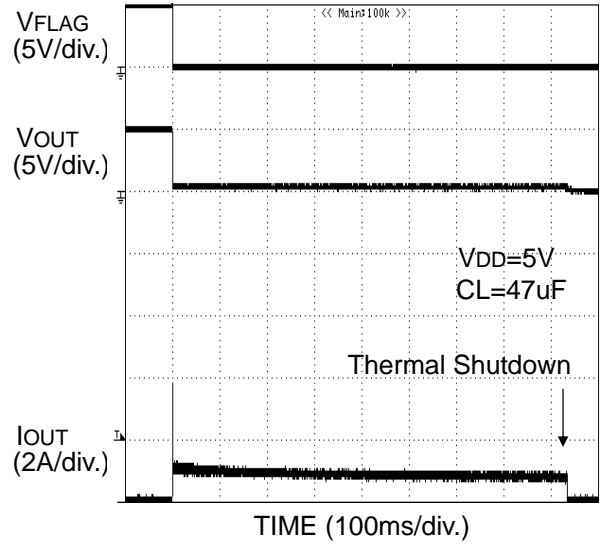

Figure 80. Over current response
Output short circuit at Enable
(BD6512F)

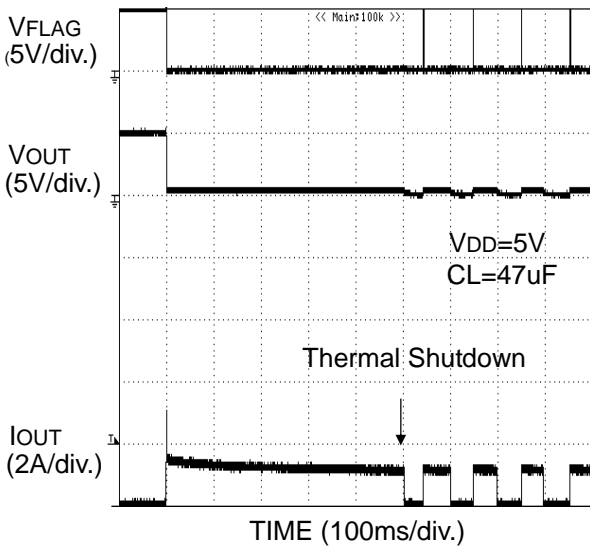

Figure 81. Over current response
Output short circuit at Enable
(BD6516F)

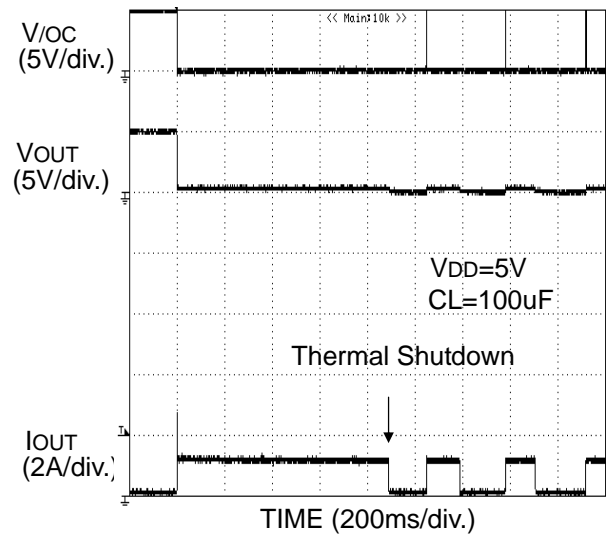
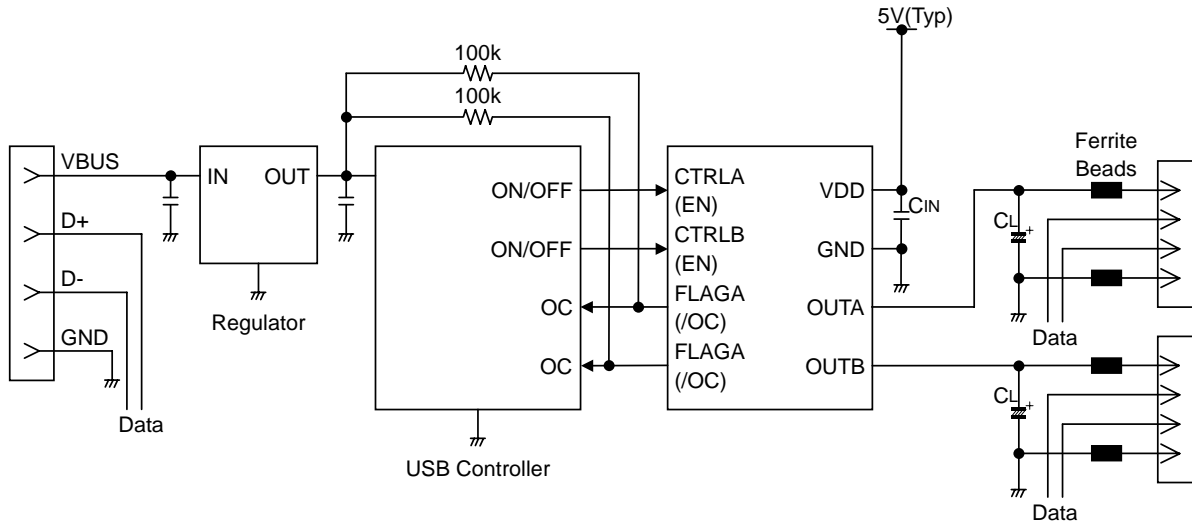

Figure 82. Over current response
Output short circuit at Enable
(BD2052AFJ)

Regarding the output rise/fall and over current detection characteristics of BD6513F, BD6517F, BD2042AFJ refer to the characteristic of BD6512F, BD6516F, BD2052AFJ.

●Typical Application Circuit



●Application Information

Excessive current flow due to output short circuit or ringing caused by the inductance from supply line of IC can cause IC malfunction during operation. To avoid this case, connect a bypass capacitor to VDD pin and GND pin of IC. 1uF or higher is recommended.

Pull up flag output by resistance of 10kΩ to 100kΩ.

Set up value which satisfies the application as CL and Ferrite Beads.

The system connection diagram doesn't guarantee operation as the application.

The external circuit constant values can be changed and should be used with adequate margins by taking into account its external parts, or behavior of IC must include not only static characteristics but also transient characteristics.

In BD6512F/BD6513F, there are cases where over current detection error flags its output by inrush current at switch on or when supplying the active line of peripheral devices. In the case of erroneous detection in BD6512F/BD6513F, use RC filter shown in Figure 83 for FLAG output.

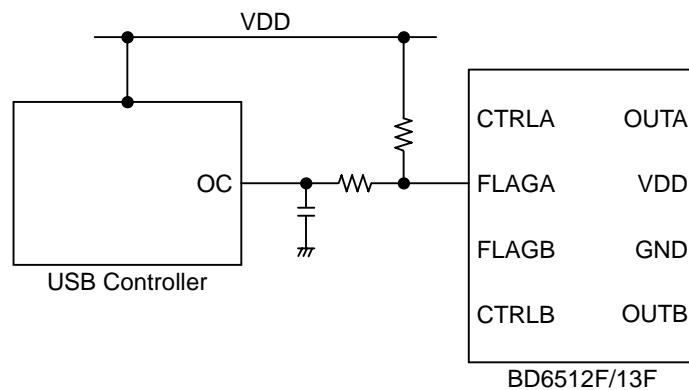

Figure 83. FLAG output RC filter

●Functional Description

1. Switch operation

VDD(IN) pin and OUT pin are connected to the drain and the source of switch MOSFET respectively. And the VDD(IN) pin is used also as power source of internal control circuit.

When the switch is turned on from CTRL(EN) control input, VDD(IN) and OUT are connected. In a normal condition, current flows from VDD to OUT. If the voltage at OUT is higher than VDD, current flows from OUT to VDD, since the switch is bidirectional.

◎BD6512F/ BD6513F

There is a parasitic diode between the drain and the source of switch MOSFET. Therefore, even when the switch is off, if the voltage of OUT is higher than that of VDD, current flows from OUT to VDD.

◎BD6516F/BD6517F/BD2042AFJ/BD2052AFJ

There is no parasitic diode and it is possible to prevent current from flowing reversely from OUT to VDD.

2. Thermal shutdown (TSD)

Thermal shut down circuit turns off the switch and outputs an error flag when the junction temperature in the chip exceeds a threshold temperature. The thermal shut down circuit works when either of two control signals is active.

In BD6512F/BD6513F/BD6516F/BD6517F, the switches of both OUTA and OUTB turn off and output an error flag;. BD2042AFJ/BD2052AFJ have dual threshold temperature for its thermal shutdown. Since thermal shutdown works at a lower junction temperature, only the switch of an overcurrent state become off whenever over current occurs and outputs an error flag.

◎BD6512F/BD6513F

If the switch off status of the thermal shut down is latched switch off and error flag output status are maintained even when the junction temperature decreases. To release the latch, it is necessary to input a signal to switch off by CTRL pin or set UVLO state. When the input signal is turned on or UVLO is released, the switch on status and error flag output resets.

◎BD6516F/BD6517F/BD2042AFJ/BD2052AFJ

Thermal shut down detection has hysteresis. Therefore, when the junction temperature goes down, switch on and error flag output automatically reset. However, until output short circuit is removed or the switch is turned off causing junction temperature to increase, thermal shut down detection and recovery are repeated.

3. Over current detection/limit circuit

The over current detection circuit limits current and outputs error flag when current flowing in each switch MOSFET exceeds a specified value. There are three types of response against over current. The over current limit detection circuit works when the switch is ON (CTRL · EN signal is active).

3-1 When the switch is turned ON while the output is in short-circuit status

When the output is in short-circuit status, the switch is set at current limit mode as soon as the switch is turned ON.

3-2 When the output short-circuits while the switch is ON

When the output short-circuits or when large current flows while the switch is ON, the over current limit circuit operates. When the current limit detection circuit works, current limitation is applied.

3-3 When the output current increases gradually

When the output current increases gradually, current limitation does not work until the output current exceeds the over current detection value. When it exceeds the detection value, current limitation is applied.

4. Under voltage lockout (UVLO)

When the supply voltage is below UVLO threshold level, UVLO circuit turns OFF the switch to prevent malfunction. The UVLO circuit works when either of two control signals is active.

◎BD6512F/BD6513F

UVLO circuit prevents the switch from turning ON until the VDD exceeds 2.5V(Typ.). If the VDD drops below 2.3V(Typ.) while the switch is ON, then UVLO shuts OFF the switch.

◎BD2042AFJ/BD2052AFJ

UVLO circuit prevents the switch from turning on until the V_{IN} exceeds 2.3V(Typ.). If the V_{IN} drops below 2.2V(Typ.) while the switch is ON, then UVLO shuts OFF the switch. UVLO has hysteresis of 100mV(Typ).

5. Error flag output

Error flag output is N-MOS open drain output.

◎BD6512F/BD6513F

At detection of over current limit, thermal shutdown, and UVLO, it output a low level signal.

◎BD6516F/BD6517F/BD2042AFJ/BD2052AFJ

At detection of over current limit and thermal shutdown, it outputs a low level signal. Error flag output at over current detection has delay filter. This delay filter prevents instantaneous current detection such as inrush current at switch ON, or applying external power supplies.

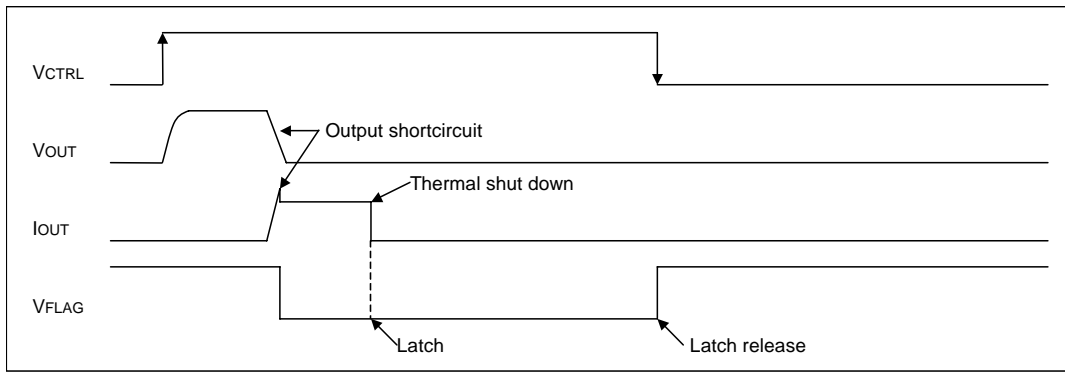

Figure 84. BD6512F/ BD6513F over current detection, thermal shutdown timing diagram (VCTRL of BD6513F active Low)

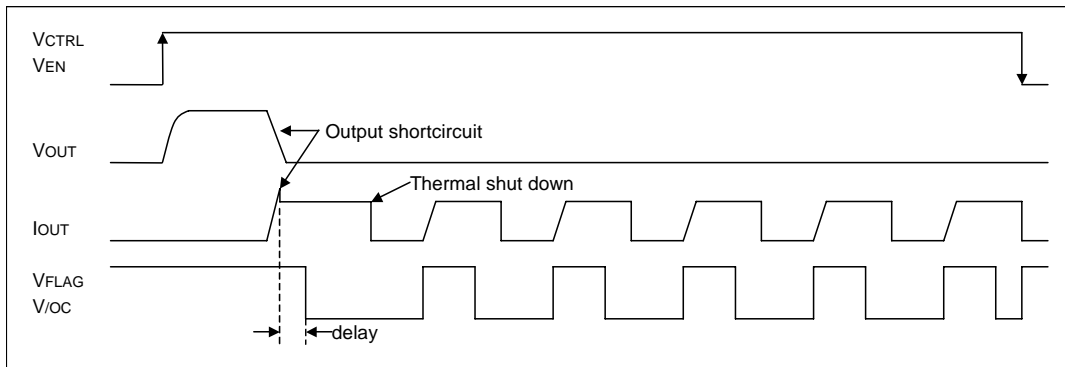

Figure 85. BD6516F/ BD6517F/BD2042AFJ/ BD2052AFJ over current detection, thermal shutdown timing diagram (VCTRL, V/EN of BD6517F/BD2042AFJ active Low)

● Power Dissipation (SOP8, SOP-J8)

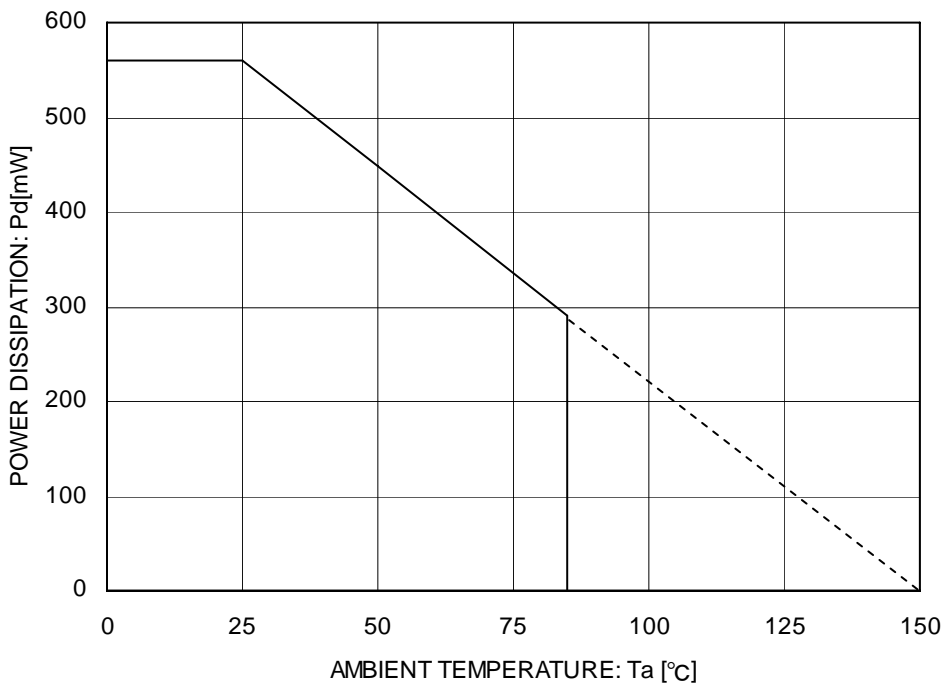

Figure 86. Power dissipation curve

● I/O Equivalent Circuit

©BD651xF Series

Symbol	Pin No.	Equivalent circuit (BD6512F/ BD6513F)	Equivalent circuit (BD6516F/ BD6517F)
CTRLA CTRLB	1, 4		
FLAGA FLAGB	2, 3		
OUTA OUTB	5, 8		

©BD20xxAFJ Series

Symbol	Pin No.	Equivalent circuit
/EN1(EN1) /EN2(EN2)	3, 4	
/OC1 /OC2	5, 8	
OUT1 OUT2	6, 7	

●Operational Notes

- (1) Absolute Maximum Ratings
Operating the IC over the absolute maximum ratings may damage the IC. The damage can either be a short circuit between pins or an open circuit between pins. Therefore, it is important to consider circuit protection measures, such as adding a fuse, in case the IC is operated over the absolute maximum ratings
- (2) Recommended operating conditions
These conditions represent a range within which the expected characteristics of the IC can be approximately obtained. The electrical characteristics are guaranteed under the conditions of each parameter.
- (3) Reverse connection of power supply
Connecting the power supply in reverse polarity can damage the IC. Take precautions against reverse polarity when connecting the power supply, such as mounting an external diode between the power supply and the IC's power supply terminals.
- (4) Power supply line
Design the PCB layout pattern to provide low impedance ground and supply lines. Separate the ground and supply lines of the digital and analog blocks to prevent noise in the ground and supply lines of the digital block from affecting the analog block. Furthermore, connect a capacitor to ground at all power supply pins. Consider the effect of temperature and aging on the capacitance value when using electrolytic capacitors.
- (5) Ground Voltage
The voltage of the ground pin must be the lowest voltage of all pins of the IC at all operating conditions. Ensure that no pins are at a voltage below the ground pin at any time, even during transient condition.
- (6) Short between pins and mounting errors
Be careful when mounting the IC on printed circuit boards. The IC may be damaged if it is mounted in a wrong orientation or if pins are shorted together. Short circuit may be caused by conductive particles caught between the pins.
- (7) Operation under strong electromagnetic field
Operating the IC in the presence of a strong electromagnetic field may cause the IC to malfunction.
- (8) Testing on application boards
When testing the IC on an application board, connecting a capacitor directly to a low-impedance output pin may subject the IC to stress. Always discharge capacitors completely after each process or step. The IC's power supply should always be turned off completely before connecting or removing it from the test setup during the inspection process. To prevent damage from static discharge, ground the IC during assembly and use similar precautions during transport and storage.
- (9) Regarding input pins of the IC
This monolithic IC contains P+ isolation and P substrate layers between adjacent elements in order to keep them isolated. P-N junctions are formed at the intersection of the P layers with the N layers of other elements, creating a parasitic diode or transistor. For example (refer to figure below):

When GND > Pin A and GND > Pin B, the P-N junction operates as a parasitic diode.

When GND > Pin B, the P-N junction operates as a parasitic transistor.

Parasitic diodes inevitably occur in the structure of the IC. The operation of parasitic diodes can result in mutual interference among circuits, operational faults, or physical damage. Therefore, conditions that cause these diodes to operate, such as applying a voltage lower than the GND voltage to an input pin (and thus to the P substrate) should be avoided.

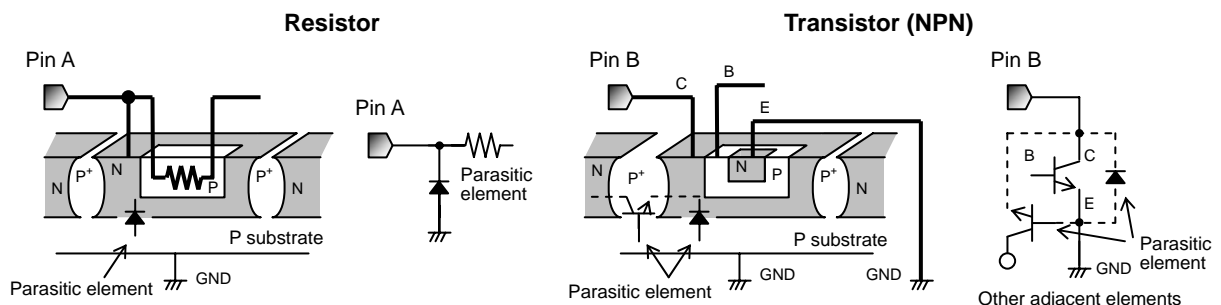

Example of monolithic IC structure

(10) GND wiring pattern

When using both small-signal and large-current GND traces, the two ground traces should be routed separately but connected to a single ground at the reference point of the application board to avoid fluctuations in the small-signal ground caused by large currents. Also ensure that the GND traces of external components do not cause variations on the GND voltage. The power supply and ground lines must be as short and thick as possible to reduce line impedance.

(11) External Capacitor

When using a ceramic capacitor, determine the dielectric constant considering the change of capacitance with temperature and the decrease in nominal capacitance due to DC bias and others.

(12) Thermal shutdown circuit (TSD)

The IC incorporates a built-in thermal shutdown circuit, which is designed to turn off the IC when the internal temperature of the IC reaches a specified value. Do not continue to operate the IC after this function is activated. Do not use the IC in conditions where this function will always be activated.

(13) Thermal consideration

Use a thermal design that allows for a sufficient margin by taking into account the permissible power dissipation (Pd) in actual operating conditions. Consider Pc that does not exceed Pd in actual operating conditions ($P_c \geq P_d$).

Package Power dissipation : $P_d (W) = (T_{jmax} - T_a) / \theta_{ja}$

Power dissipation : $P_c (W) = (V_{cc} - V_o) \times I_o + V_{cc} \times I_b$

(T_{jmax} : Maximum junction temperature=150°C, T_a : Peripheral temperature[°C],
 θ_{ja} : Thermal resistance of package-ambience[°C/W], P_d : Package Power dissipation [W],
 P_c : Power dissipation [W], V_{cc} : Input Voltage, V_o : Output Voltage, I_o : Load, I_b : Bias Current)

●Ordering Information

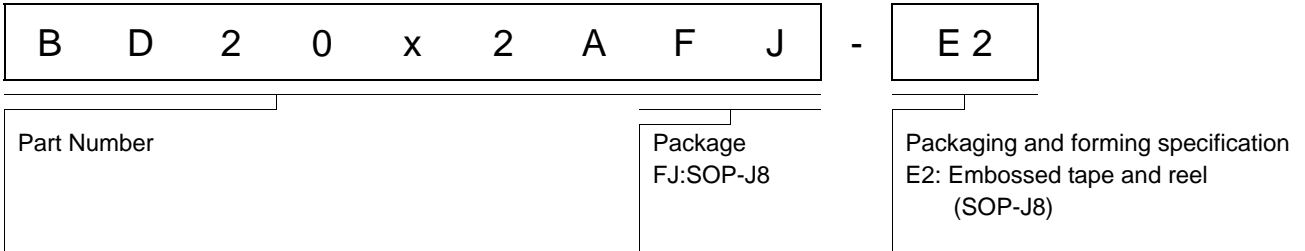
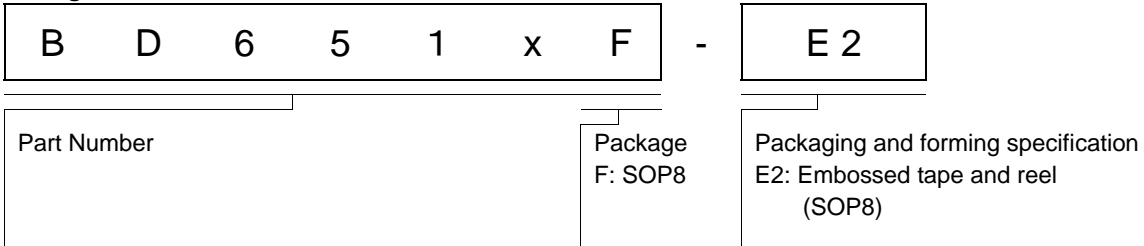

●Marking Diagrams

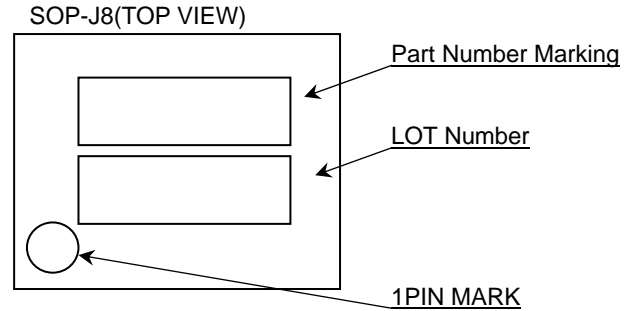
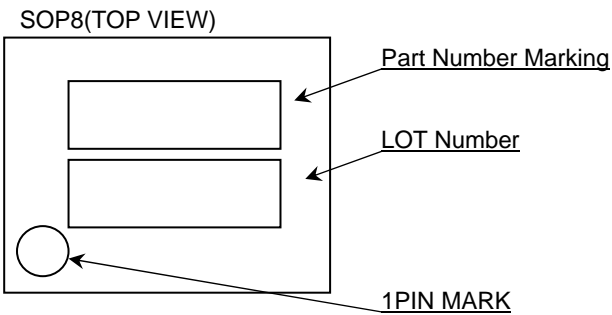

Part Number	Part Number Marking
BD6512F	D6512
BD6513F	D6513
BD6516F	D6516
BD6517F	D6517
BD2042AFJ	D042A
BD2052AFJ	D052A

●Physical Dimension, Tape and Reel Information

Package Name	SOP8
--------------	------

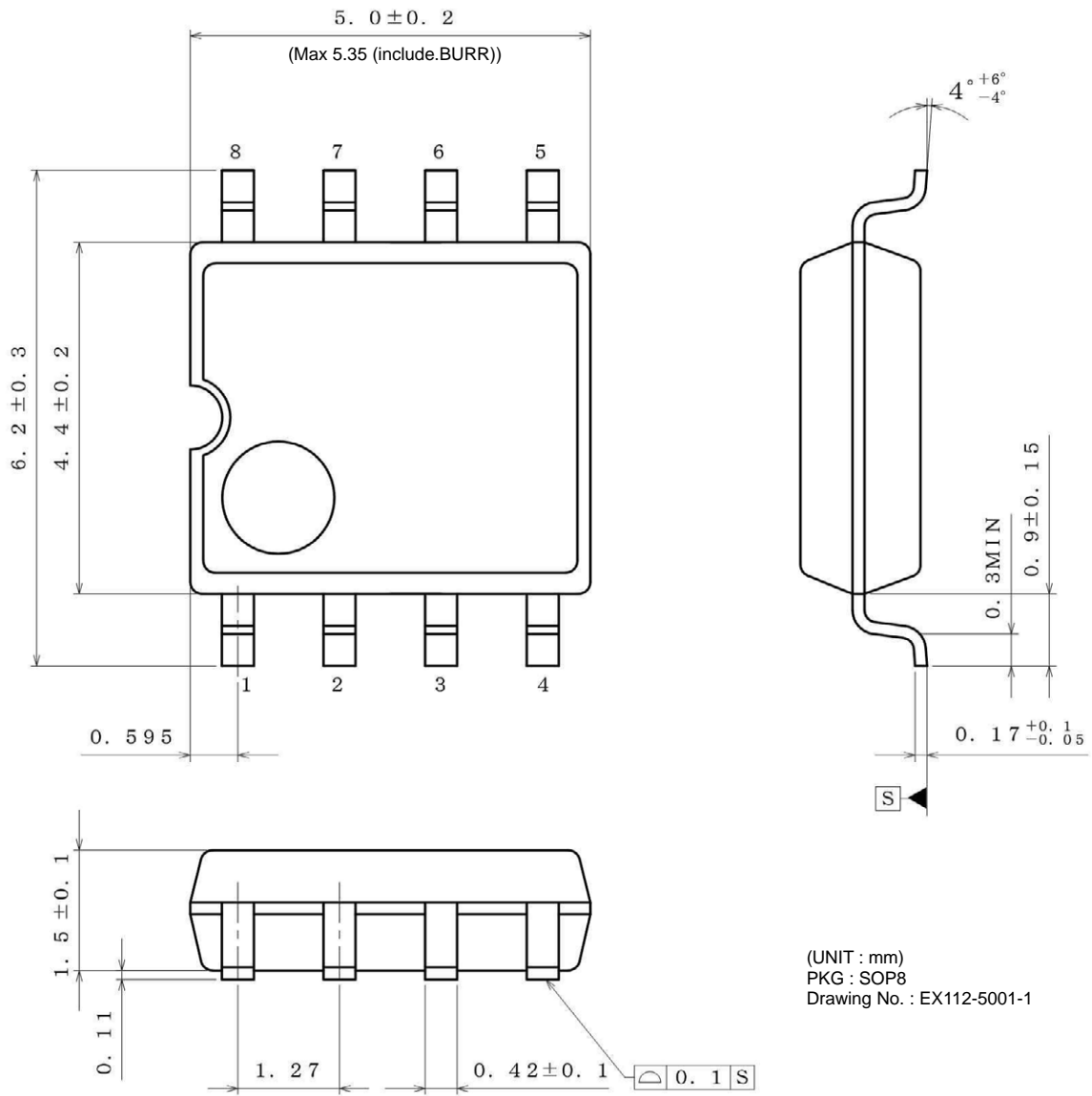

(UNIT : mm)
 PKG : SOP8
 Drawing No. : EX112-5001-1

<Tape and Reel information>

Tape	Embossed carrier tape
Quantity	2500pcs
Direction of feed	E2 (The direction is the 1pin of product is at the upper left when you hold reel on the left hand and you pull out the tape on the right hand)

Reel

1pin

Direction of feed

*Order quantity needs to be multiple of the minimum quantity.

●Physical Dimension, Tape and Reel Information – continued

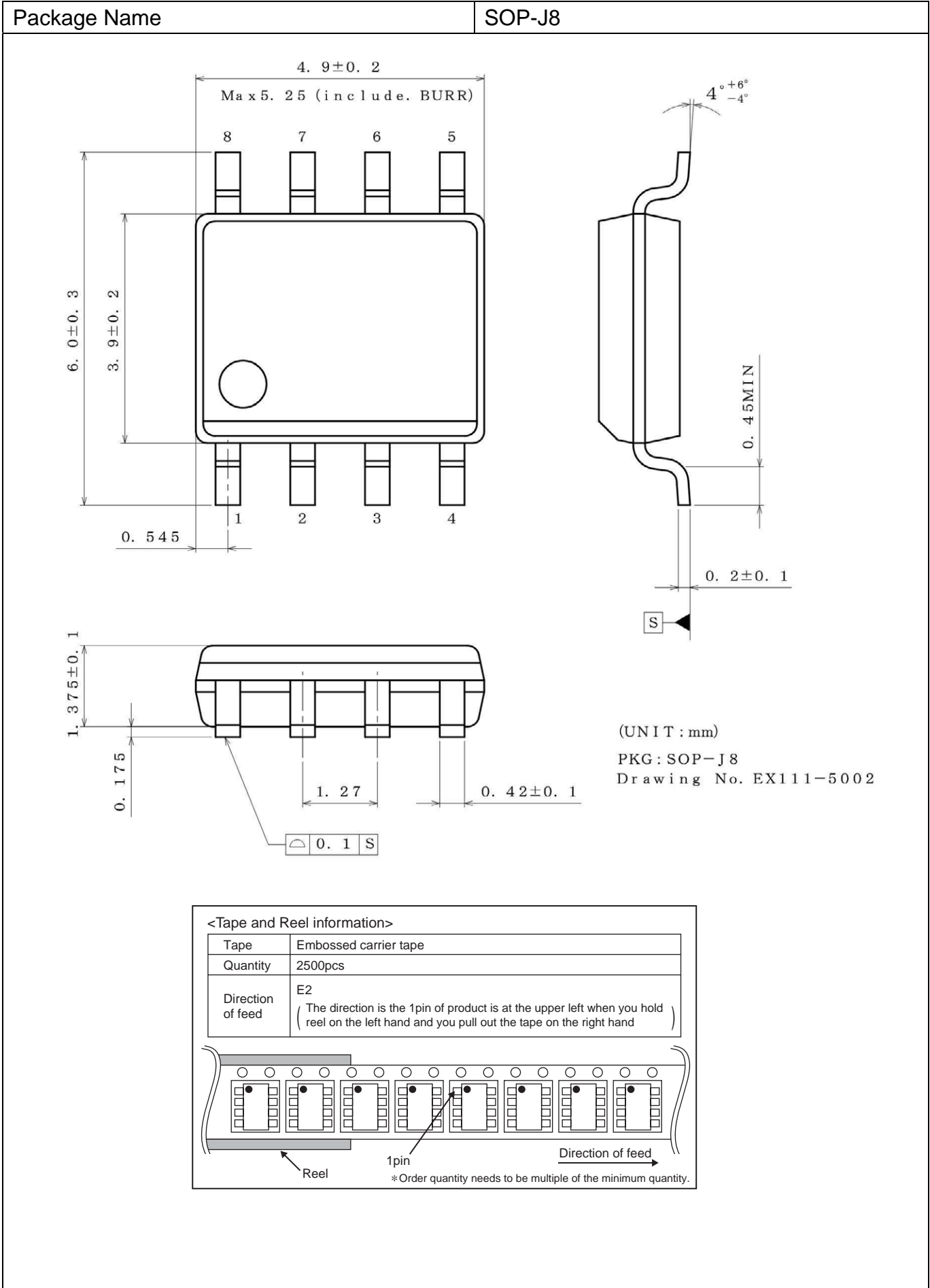

●Revision History

Date	Revision	Changes
11.Mar.2013	001	New Release

Notice

●General Precaution

- 1) Before you use our Products, you are requested to carefully read this document and fully understand its contents. ROHM shall not be in any way responsible or liable for failure, malfunction or accident arising from the use of any ROHM's Products against warning, caution or note contained in this document.
- 2) All information contained in this document is current as of the issuing date and subject to change without any prior notice. Before purchasing or using ROHM's Products, please confirm the latest information with a ROHM sales representative.

●Precaution on using ROHM Products

- 1) Our Products are designed and manufactured for application in ordinary electronic equipments (such as AV equipment, OA equipment, telecommunication equipment, home electronic appliances, amusement equipment, etc.). If you intend to use our Products in devices requiring extremely high reliability (such as medical equipment, transport equipment, traffic equipment, aircraft/spacecraft, nuclear power controllers, fuel controllers, car equipment including car accessories, safety devices, etc.) and whose malfunction or failure may cause loss of human life, bodily injury or serious damage to property ("Specific Applications"), please consult with the ROHM sales representative in advance. Unless otherwise agreed in writing by ROHM in advance, ROHM shall not be in any way responsible or liable for any damages, expenses or losses incurred by you or third parties arising from the use of any ROHM's Products for Specific Applications.
- 2) ROHM designs and manufactures its Products subject to strict quality control system. However, semiconductor products can fail or malfunction at a certain rate. Please be sure to implement, at your own responsibilities, adequate safety measures including but not limited to fail-safe design against the physical injury, damage to any property, which a failure or malfunction of our Products may cause. The following are examples of safety measures:
 - [a] Installation of protection circuits or other protective devices to improve system safety
 - [b] Installation of redundant circuits to reduce the impact of single or multiple circuit failure
- 3) Our Products are designed and manufactured for use under standard conditions and not under any special or extraordinary environments or conditions, as exemplified below. Accordingly, ROHM shall not be in any way responsible or liable for any damages, expenses or losses arising from the use of any ROHM's Products under any special or extraordinary environments or conditions. If you intend to use our Products under any special or extraordinary environments or conditions (as exemplified below), your independent verification and confirmation of product performance, reliability, etc. prior to use, must be necessary:
 - [a] Use of our Products in any types of liquid, including water, oils, chemicals, and organic solvents
 - [b] Use of our Products outdoors or in places where the Products are exposed to direct sunlight or dust
 - [c] Use of our Products in places where the Products are exposed to sea wind or corrosive gases, including Cl₂, H₂S, NH₃, SO₂, and NO₂
 - [d] Use of our Products in places where the Products are exposed to static electricity or electromagnetic waves
 - [e] Use of our Products in proximity to heat-producing components, plastic cords, or other flammable items
 - [f] Sealing or coating our Products with resin or other coating materials
 - [g] Use of our Products without cleaning residue of flux (even if you use no-clean type fluxes, cleaning residue of flux is recommended); or Washing our Products by using water or water-soluble cleaning agents for cleaning residue after soldering
 - [h] Use of the Products in places subject to dew condensation
- 4) The Products are not subject to radiation-proof design.
- 5) Please verify and confirm characteristics of the final or mounted products in using the Products.
- 6) In particular, if a transient load (a large amount of load applied in a short period of time, such as pulse) is applied, confirmation of performance characteristics after on-board mounting is strongly recommended. Avoid applying power exceeding normal rated power; exceeding the power rating under steady-state loading condition may negatively affect product performance and reliability.
- 7) De-rate Power Dissipation (Pd) depending on Ambient temperature (Ta). When used in sealed area, confirm the actual ambient temperature.
- 8) Confirm that operation temperature is within the specified range described in the product specification.
- 9) ROHM shall not be in any way responsible or liable for failure induced under deviant condition from what is defined in this document.

● **Precaution for Mounting / Circuit board design**

- 1) When a highly active halogenous (chlorine, bromine, etc.) flux is used, the residue of flux may negatively affect product performance and reliability.
- 2) In principle, the reflow soldering method must be used; if flow soldering method is preferred, please consult with the ROHM representative in advance.

For details, please refer to ROHM Mounting specification

● **Precautions Regarding Application Examples and External Circuits**

- 1) If change is made to the constant of an external circuit, please allow a sufficient margin considering variations of the characteristics of the Products and external components, including transient characteristics, as well as static characteristics.
- 2) You agree that application notes, reference designs, and associated data and information contained in this document are presented only as guidance for Products use. Therefore, in case you use such information, you are solely responsible for it and you must exercise your own independent verification and judgment in the use of such information contained in this document. ROHM shall not be in any way responsible or liable for any damages, expenses or losses incurred by you or third parties arising from the use of such information.

● **Precaution for Electrostatic**

This Product is electrostatic sensitive product, which may be damaged due to electrostatic discharge. Please take proper caution in your manufacturing process and storage so that voltage exceeding the Products maximum rating will not be applied to Products. Please take special care under dry condition (e.g. Grounding of human body / equipment / solder iron, isolation from charged objects, setting of Ionizer, friction prevention and temperature / humidity control).

● **Precaution for Storage / Transportation**

- 1) Product performance and soldered connections may deteriorate if the Products are stored in the places where:
 - [a] the Products are exposed to sea winds or corrosive gases, including Cl₂, H₂S, NH₃, SO₂, and NO₂
 - [b] the temperature or humidity exceeds those recommended by ROHM
 - [c] the Products are exposed to direct sunshine or condensation
 - [d] the Products are exposed to high Electrostatic
- 2) Even under ROHM recommended storage condition, solderability of products out of recommended storage time period may be degraded. It is strongly recommended to confirm solderability before using Products of which storage time is exceeding the recommended storage time period.
- 3) Store / transport cartons in the correct direction, which is indicated on a carton with a symbol. Otherwise bent leads may occur due to excessive stress applied when dropping of a carton.
- 4) Use Products within the specified time after opening a humidity barrier bag. Baking is required before using Products of which storage time is exceeding the recommended storage time period.

● **Precaution for Product Label**

QR code printed on ROHM Products label is for ROHM's internal use only.

● **Precaution for Disposition**

When disposing Products please dispose them properly using an authorized industry waste company.

● **Precaution for Foreign Exchange and Foreign Trade act**

Since our Products might fall under controlled goods prescribed by the applicable foreign exchange and foreign trade act, please consult with ROHM representative in case of export.

● **Precaution Regarding Intellectual Property Rights**

- 1) All information and data including but not limited to application example contained in this document is for reference only. ROHM does not warrant that foregoing information or data will not infringe any intellectual property rights or any other rights of any third party regarding such information or data. ROHM shall not be in any way responsible or liable for infringement of any intellectual property rights or other damages arising from use of such information or data.:
- 2) No license, expressly or implied, is granted hereby under any intellectual property rights or other rights of ROHM or any third parties with respect to the information contained in this document.

● **Other Precaution**

- 1) The information contained in this document is provided on an "as is" basis and ROHM does not warrant that all information contained in this document is accurate and/or error-free. ROHM shall not be in any way responsible or liable for any damages, expenses or losses incurred by you or third parties resulting from inaccuracy or errors of or concerning such information.
- 2) This document may not be reprinted or reproduced, in whole or in part, without prior written consent of ROHM.
- 3) The Products may not be disassembled, converted, modified, reproduced or otherwise changed without prior written consent of ROHM.
- 4) In no event shall you use in any way whatsoever the Products and the related technical information contained in the Products or this document for any military purposes, including but not limited to, the development of mass-destruction weapons.
- 5) The proper names of companies or products described in this document are trademarks or registered trademarks of ROHM, its affiliated companies or third parties.