



PRODUCT DATASHEET ANGELINA series

last update 3/11/2016

DETAILS

Product Number	FCN13693_ANGELINA-W
Family	ANGELINA
Type	RefPack
Color	metal
Diameter	82 mm
Height	36 mm
Style	round
Optic Material	
Holder Material	
Fastening	
Status	production ready
ROHS Compliant	Yes
Date Updated	3/11/2016



OPTICAL PROPERTIES

LED	Viewing Angle	Light Beam	Efficiency	cd/lm	Connector
VERO29	64 deg	Wide	89 %	0.800	LEDiL: LEDiL
CLL04x/CLU04x	54 deg	Wide	92 %	0.960	Bender Wirth: 431 Typ L3
LUXEON CoB 1211	55 deg	Wide	93 %	0.940	Bender Wirth: 431 Typ L3
Soleriq S19	48 deg	Wide	91 %	1.000	Bender Wirth: 462 Typ L3
MJT COB LES 22	58 deg	Wide	90 %	0.870	Bender Wirth: 431 Typ L3

H G F E D C B A

4

3

2

1

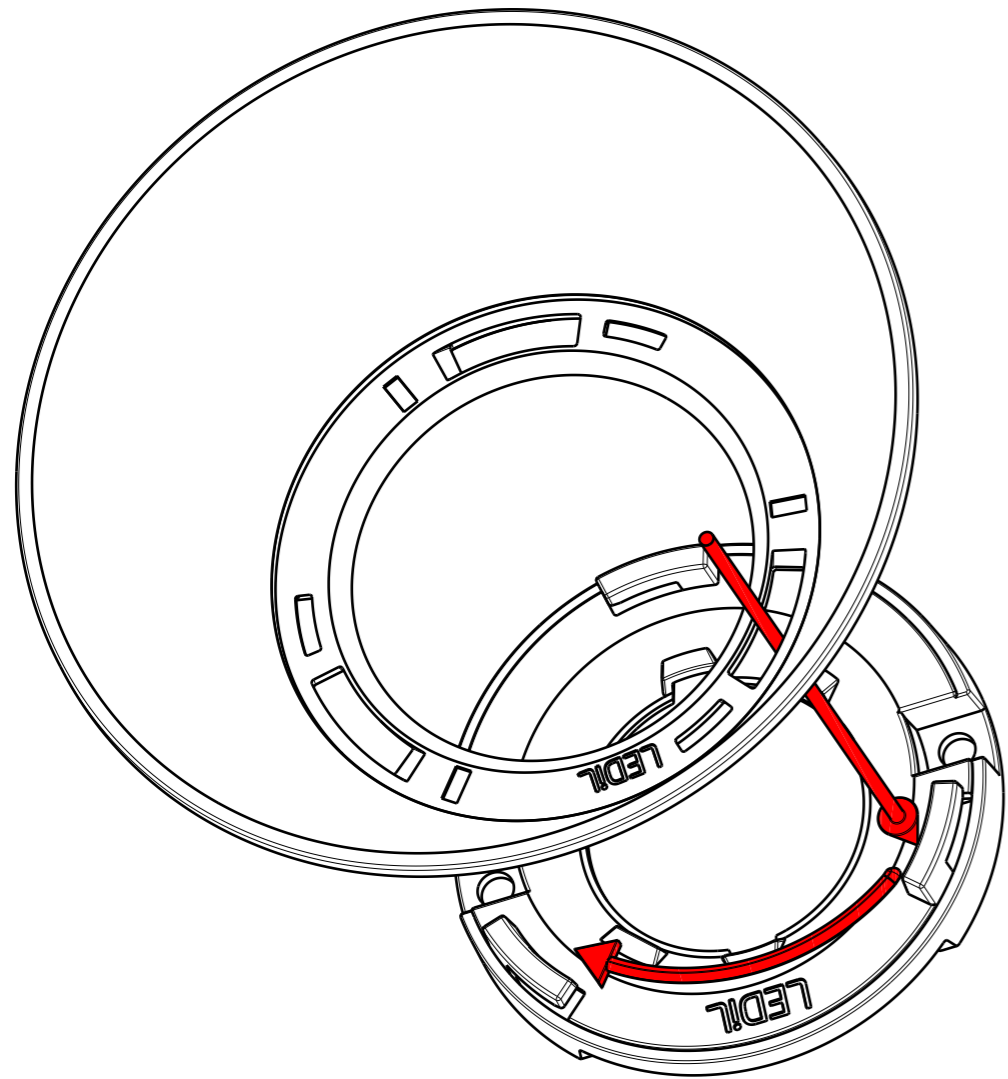

31 + Basepart

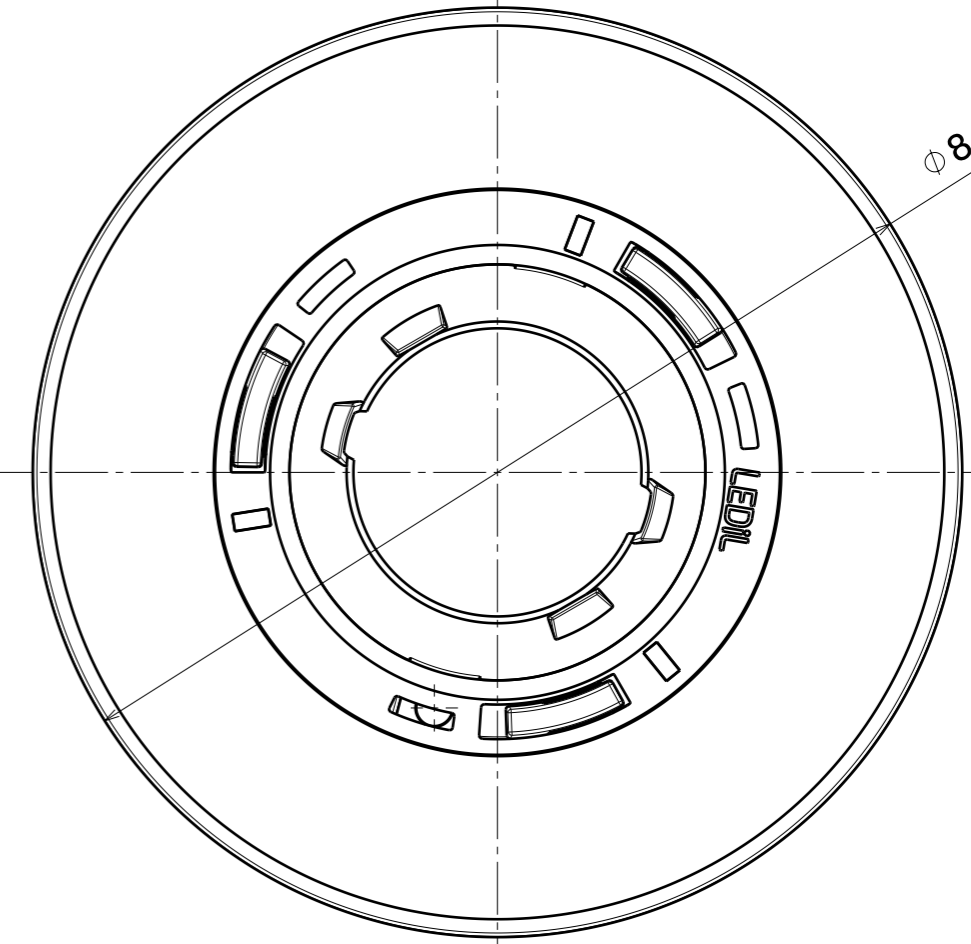
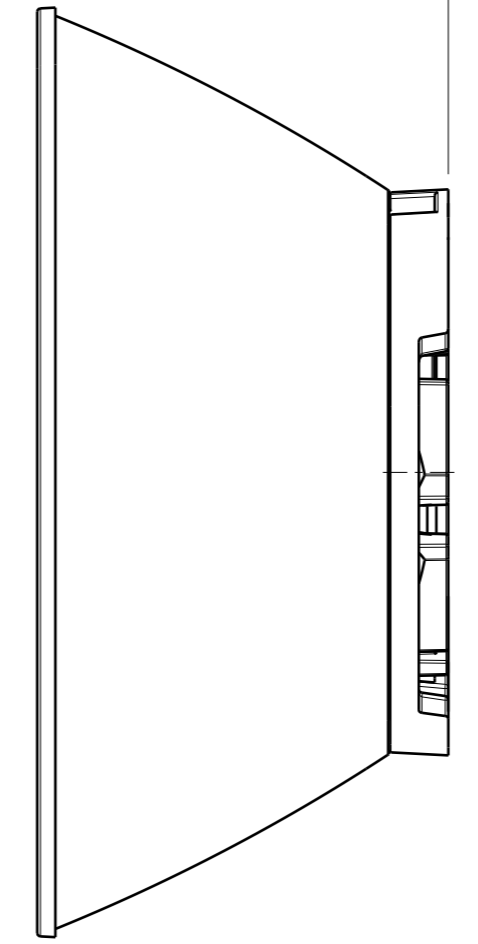

4

3

2

1

H G B A

Tolerances if not otherwise shown
 According to DIN ISO 2768-1
 Linear measures:
 Up to 30mm class M, otherwise class C.
 According to DIN ISO 2768-2
 Form and position: class L

LEDiL LediL Oy
 Salorankatu 10
 FIN 24240 SALO
 Finland

THIRD ANGLE PROJECTION:

DRAWING TITLE
Datasheet_ANGELINA + CLAMP

This drawing is the property
 of LEDiL Oy. It may not be
 reproduced, copied or
 communicated without a written
 agreement with LEDiL Oy.

SIZE	PART NUMBER		
A3	-		

SCALE	3:2	WEIGHT	(g)	SHEET	1/1
-------	-----	--------	-----	-------	-----

Luminaire: LEDiL Oy FCN13693_ANGELINA-W_(VERO29) Eff.89.5%
Lamps: 1 x BRIDGELUX_VERO29 (BXRC-50C10K0-L-04) 1381.64lm@250mA CCT=5000K P=9W I=250mA

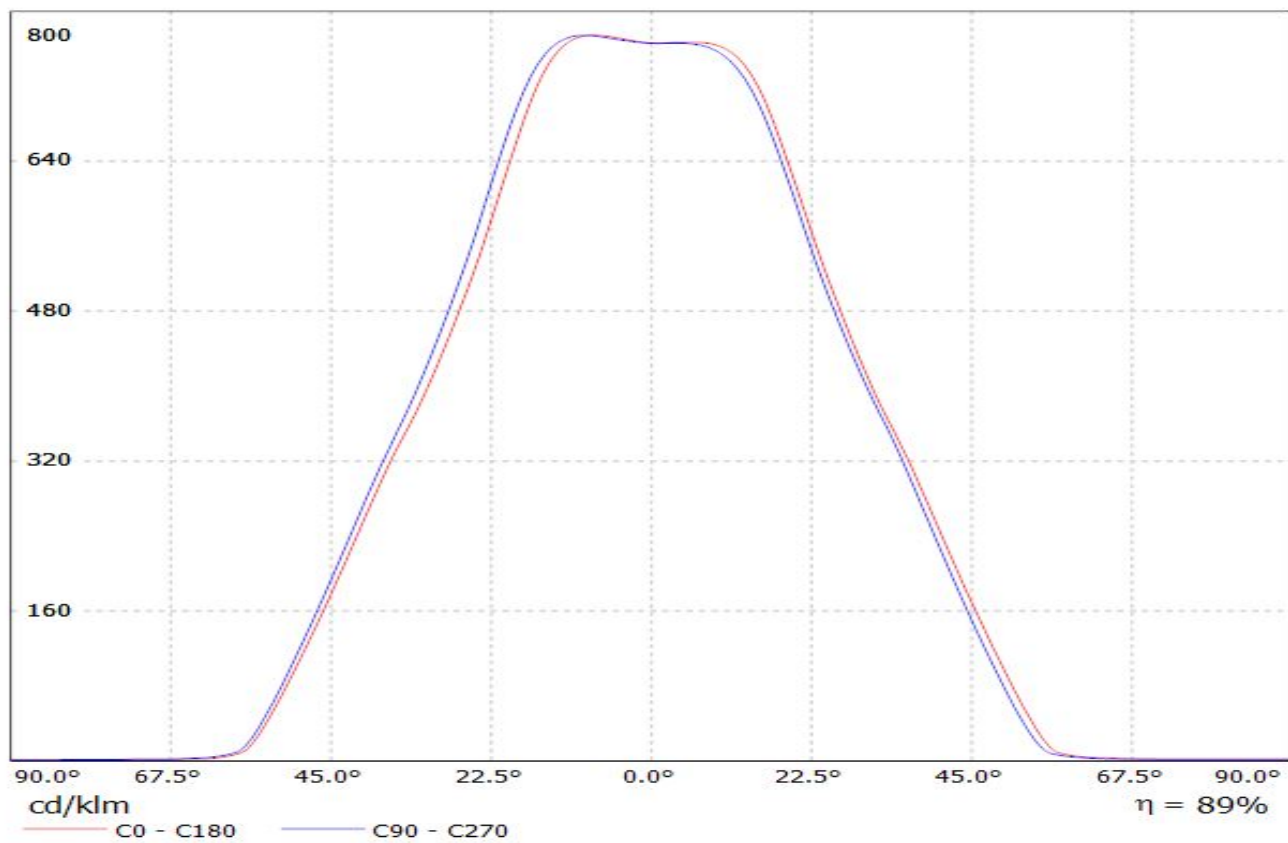

Luminaire: Ledil FCN13693_ANGELINA-W_(CLU044)_(431_Typ_L3)

Lamps: 1 x Citizen_CLU044_(CLU044-1212B8-303M1A2)_1272.54lm@250mA_P=8.16W_I=0.25A

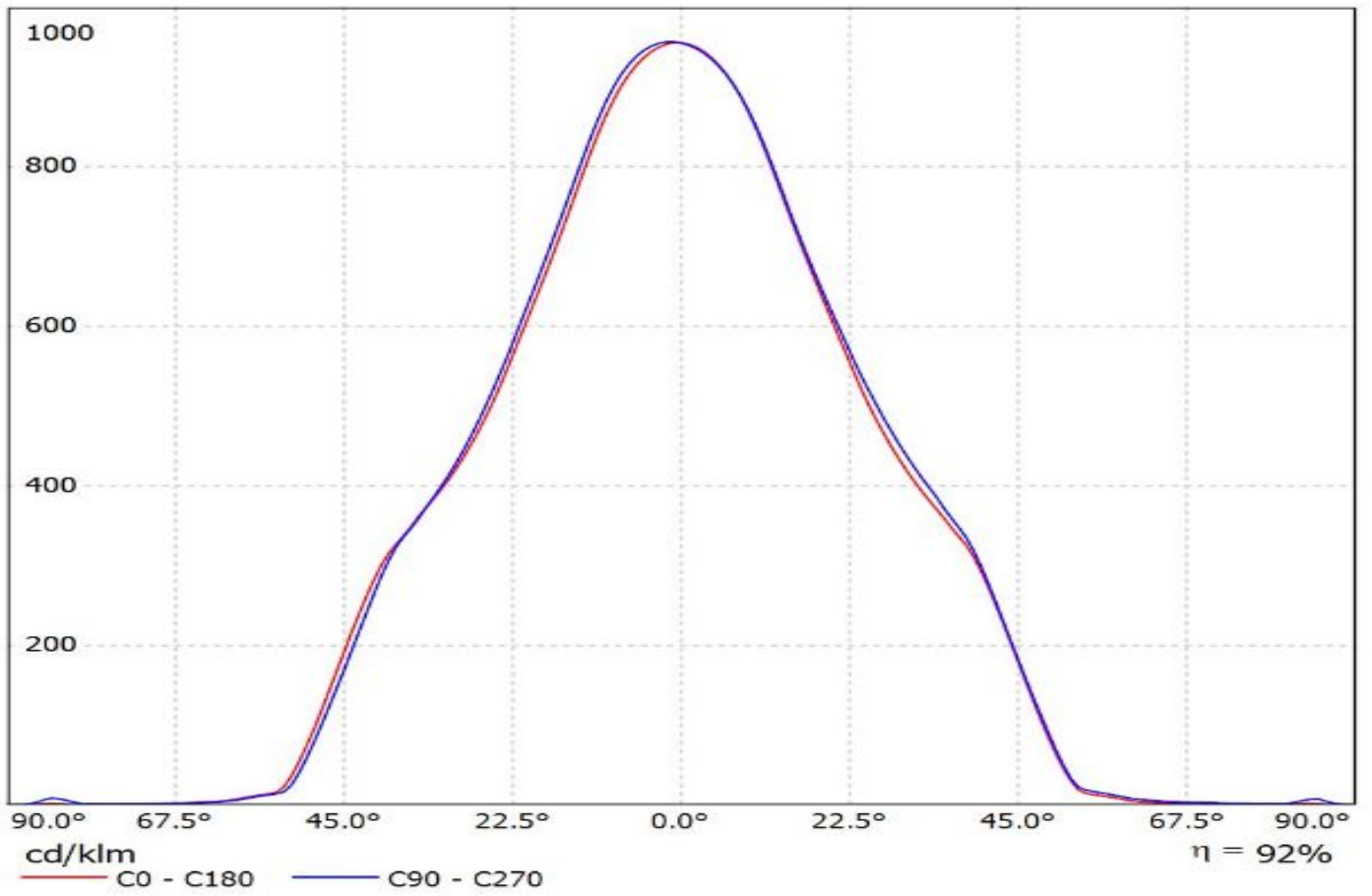

Luminaire: LEDiL Oy FCN13704_ANGELA-W_(CoB_1211)_(431_Typ_L3)

Lamps: 1 x Luxeon_CoB_1211_(LHC1-5780-1211)_(431_Typ_L3)_(C13867)_897.994lm@250mA_P=8W_I=0.25A

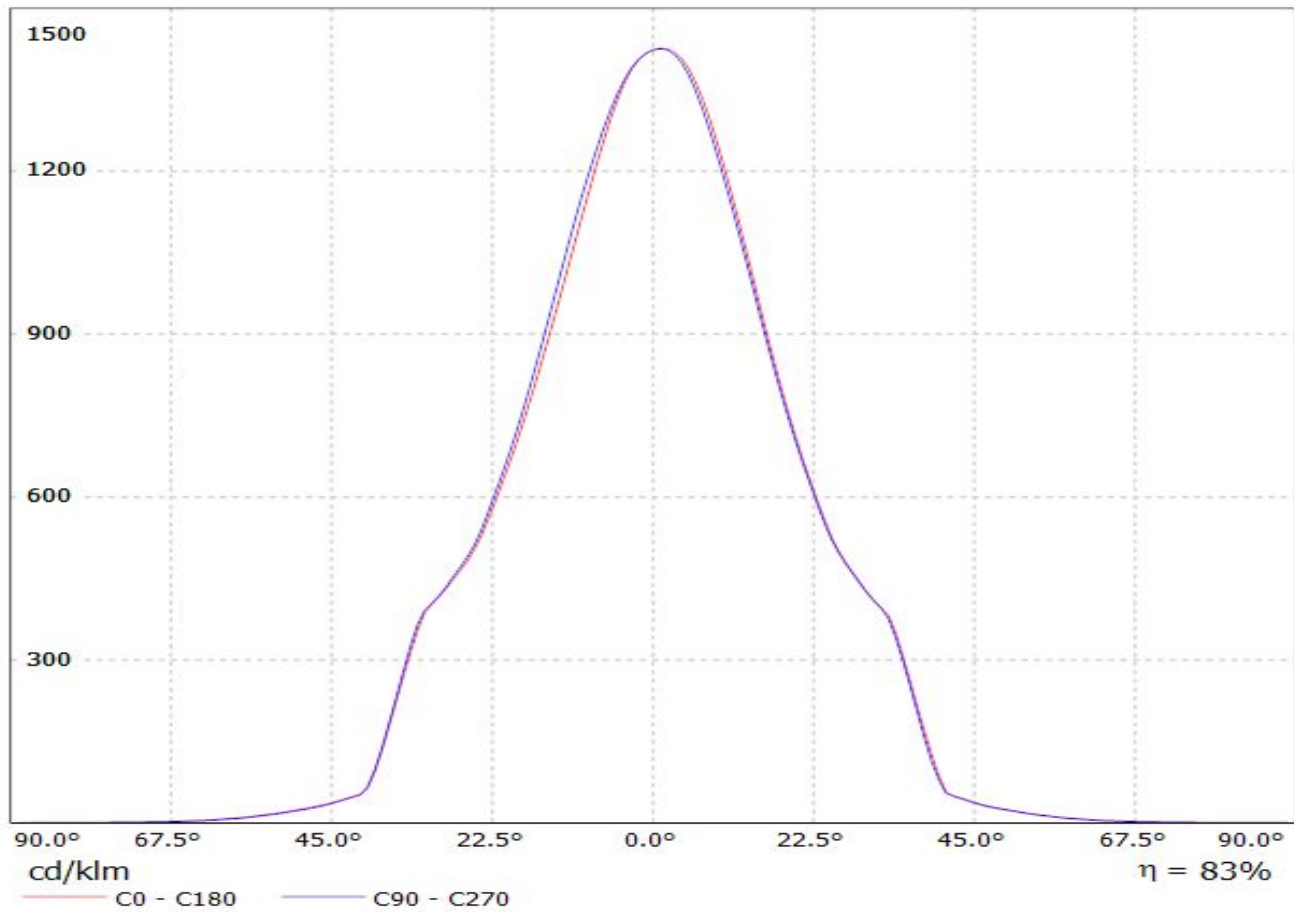

Luminaire: LEDiL Oy FCN13693_ANGELINA-W_(Soleriq_S19)_462_Typ_L3

Lamps: 1 x Osram_Soleriq_S19_(GW_KAHJB1.EM)_1497.37lm@250mA_P=11.1223W_I=0.2532A

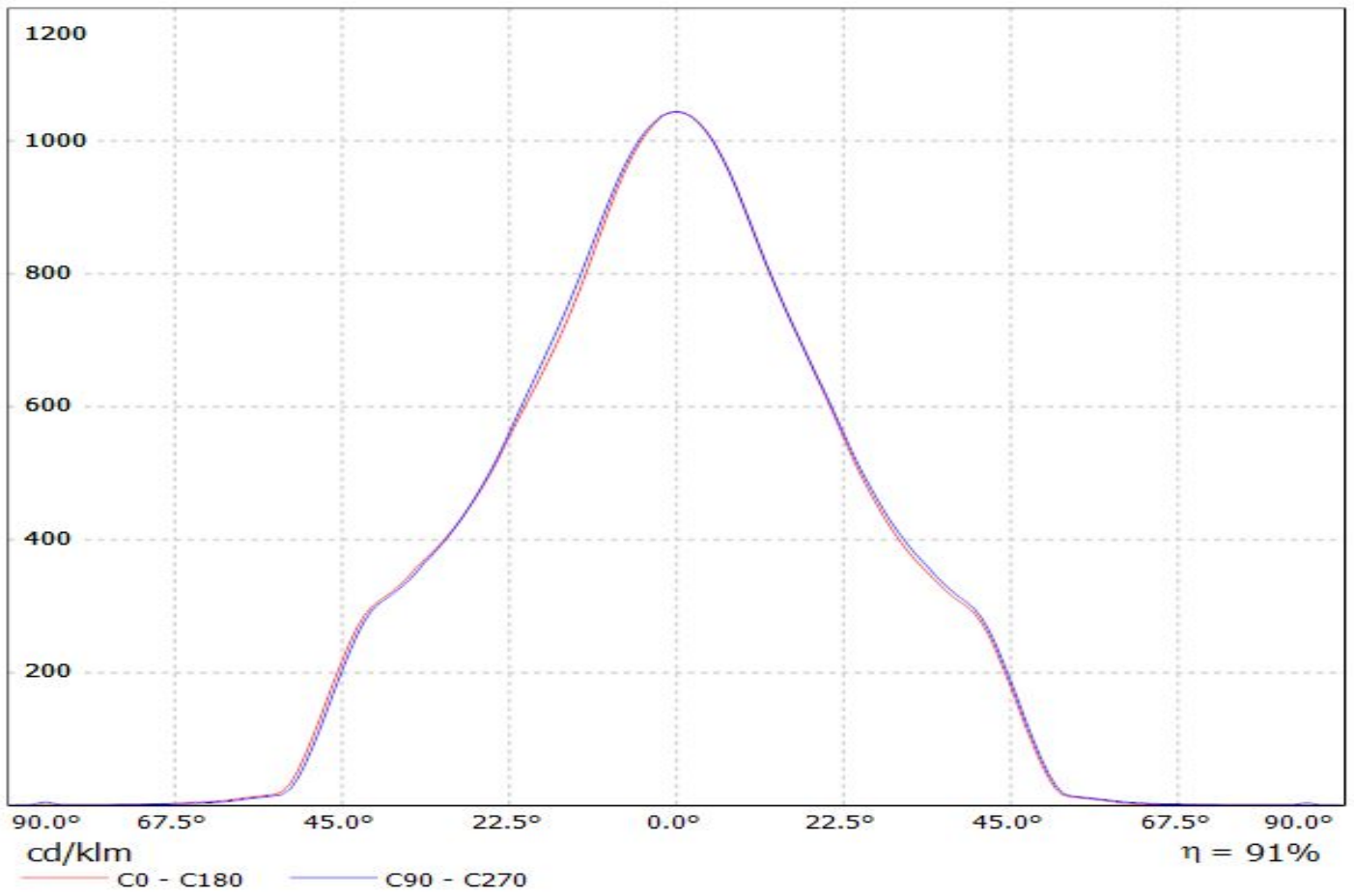

Luminaire: Ledil FCN13693_ANGELINA-W_(MJT_80W_Les22)_+431TypL3

Lamps: 1 x Seoul_MJT_80W_Les22mm_(SAWx22AAA)+_VÉRO29+_431TypL3_2407.73lm@250mA_P=13.2662W_I=0.25A

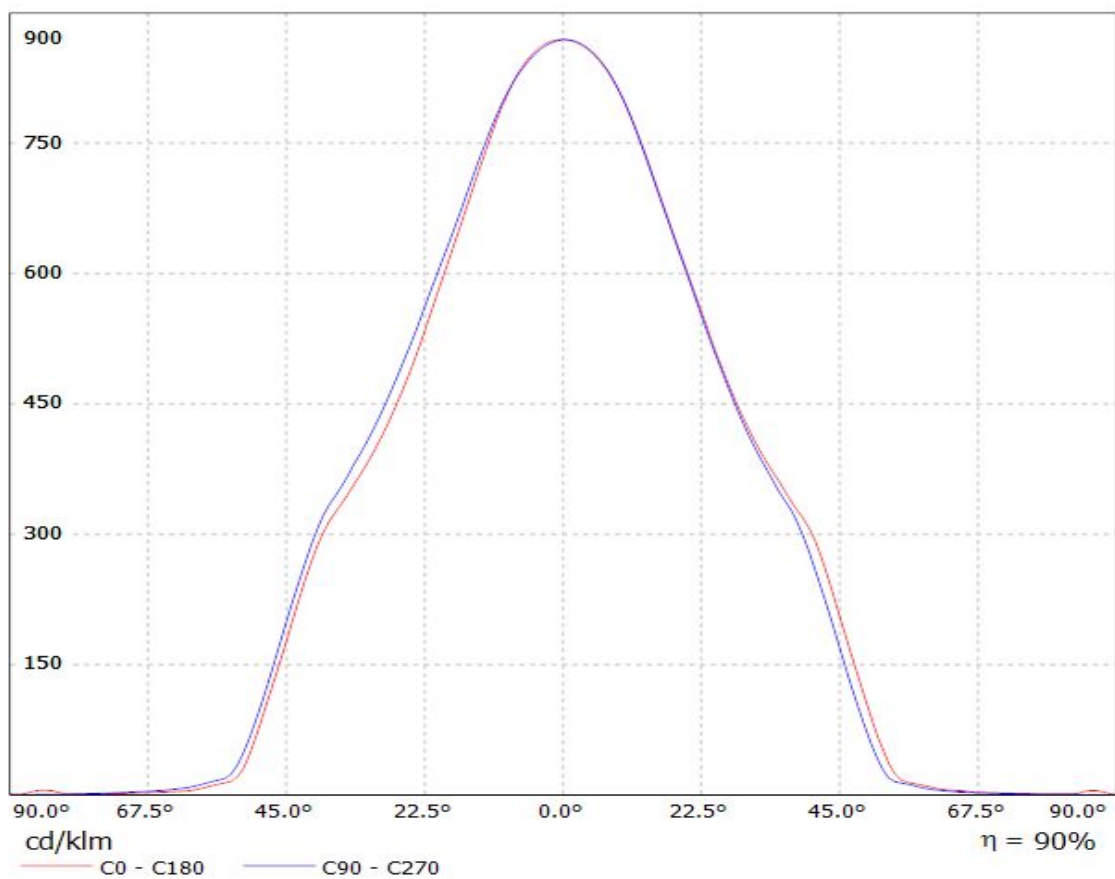

Luminaire: LEDiL Oy FCN13693_ANGELINA-W_(VERO29) Eff.89.5%

Lamps: 1 x BRIDGELUX_VERO29 (BXRC-50C10K0-L-04) 1381.64lm@250mA CCT=5000K P=9W I=250mA

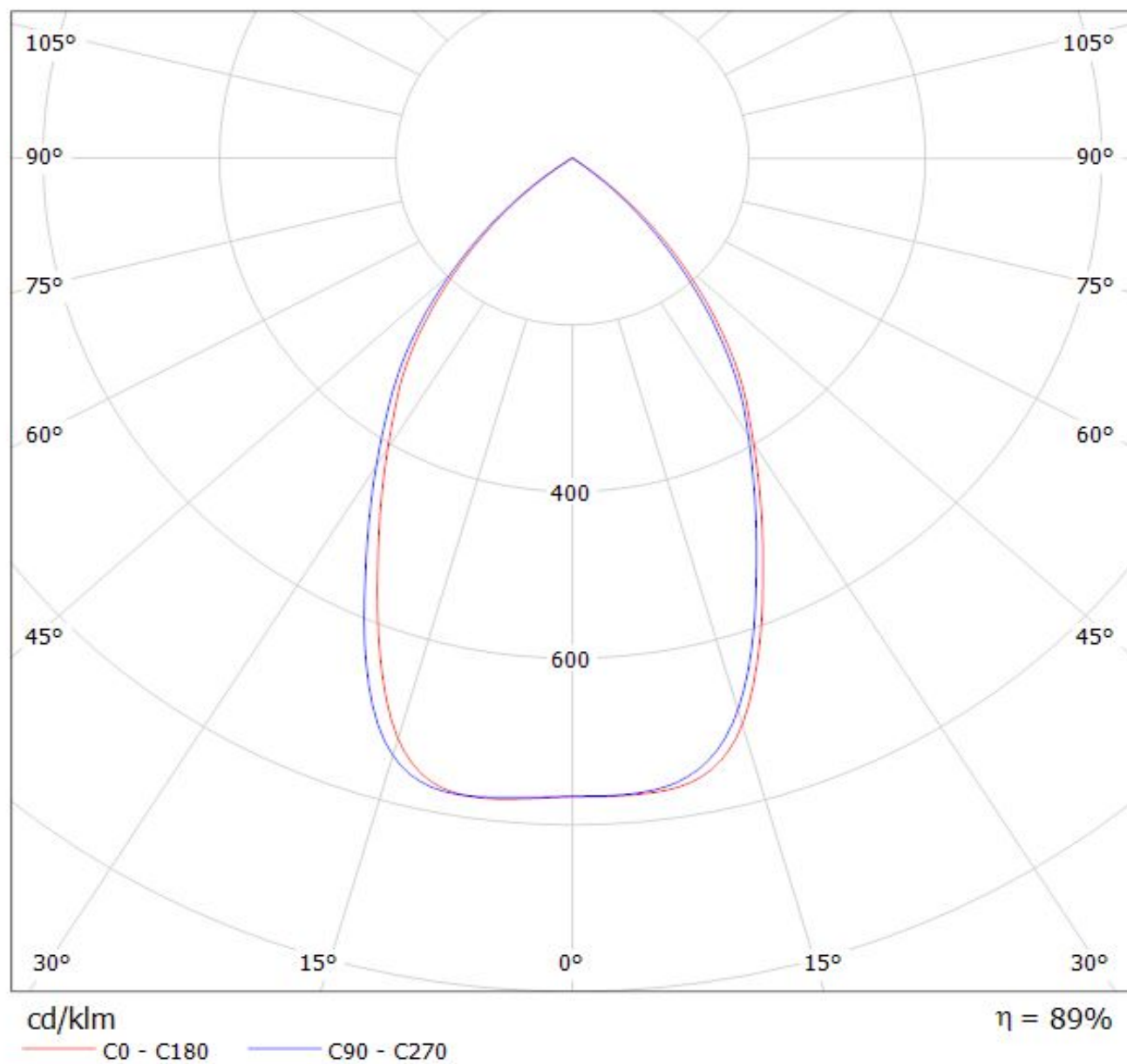

Luminaire: Ledil FCN13693_ANGELINA-W_(CLU044)_ (431_Typ_L3)

Lamps: 1 x Citizen_CLU044_(CLU044-1212B8-303M1A2)_ 1272.54lm@250mA_P=8.16W_I=0.25A

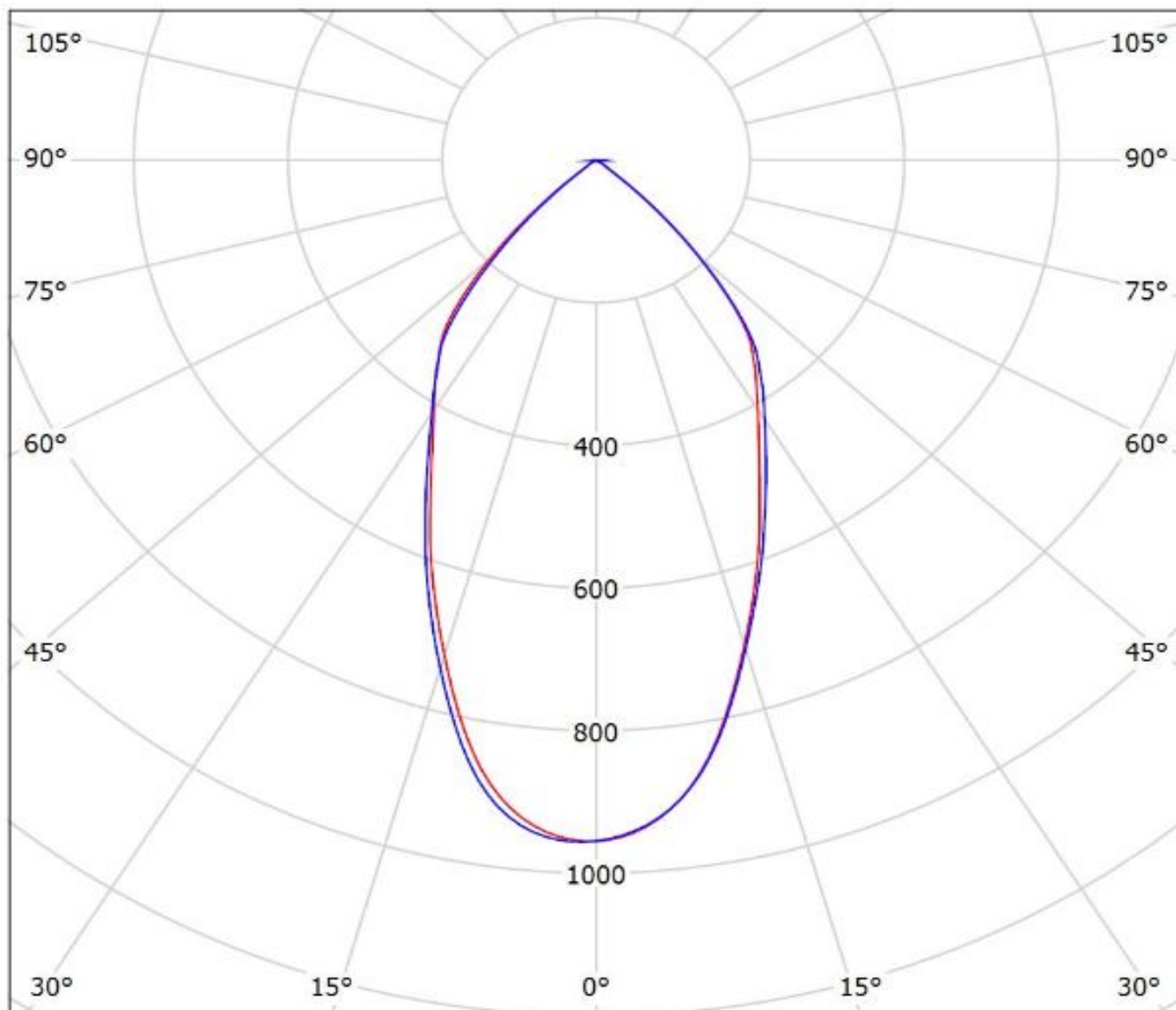

cd/klm

— C0 - C180

— C90 - C270

$\eta = 92\%$

Luminaire: LEDiL Oy FCN13704_ANGELA-W_(CoB_1211)_ (431_Typ_L3)

Lamps: 1 x Luxeon_CoB_1211_(LHC1-5780-1211)_ (431_Typ_L3)_ (C13867)_897.994lm@250mA_P=8W_I=0.25A

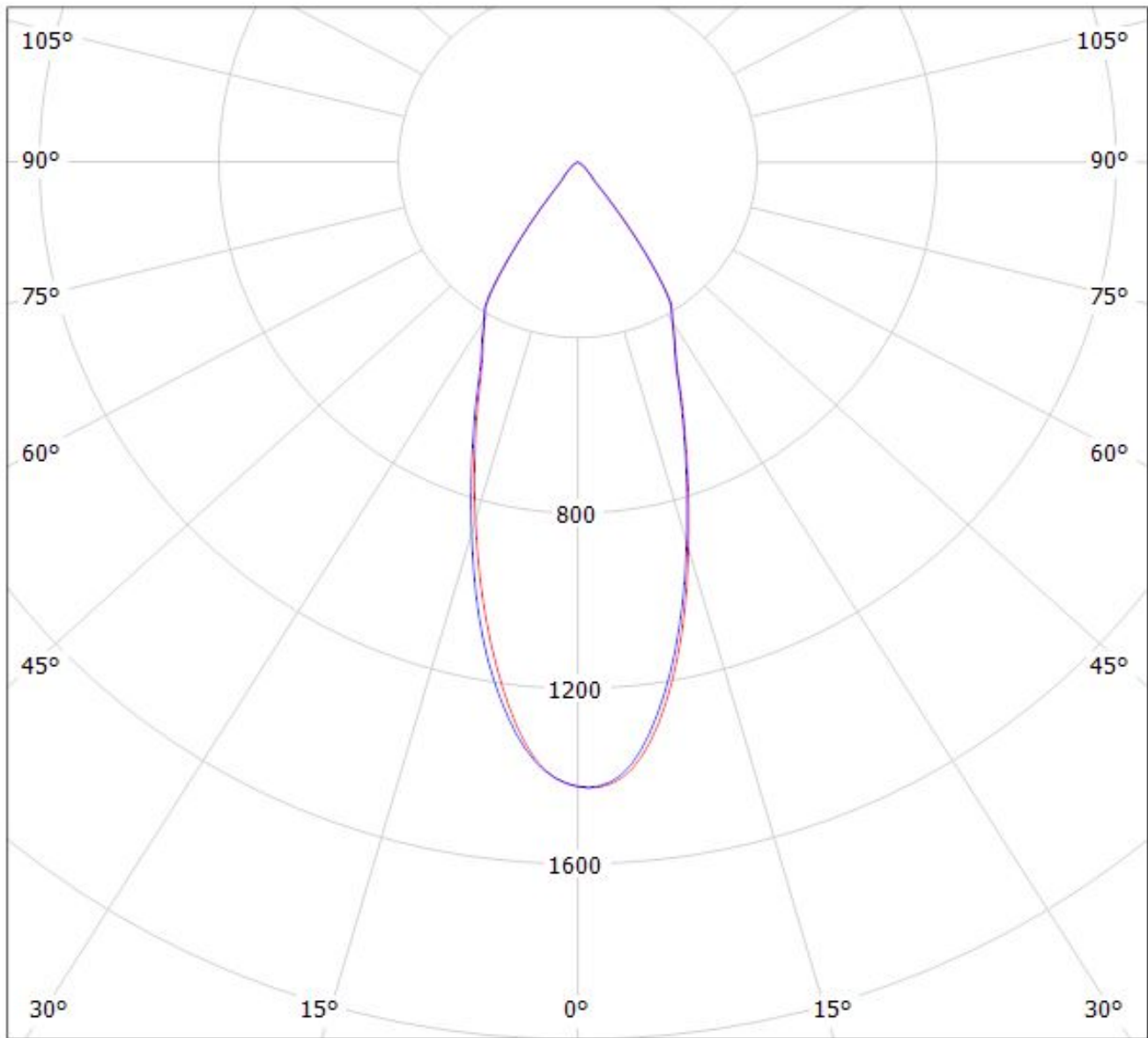

cd/klm

$\eta = 83\%$

— C0 - C180

— C90 - C270

Luminaire: LEDiL Oy FCN13693_ANGELINA-W_(Soleriq_S19)_462_Typ_L3
Lamps: 1 x Osram_Soleriq_S19_(GW_KAHJB1.EM)_1497.37lm@250mA_P=11.1223W_I=0.2532A

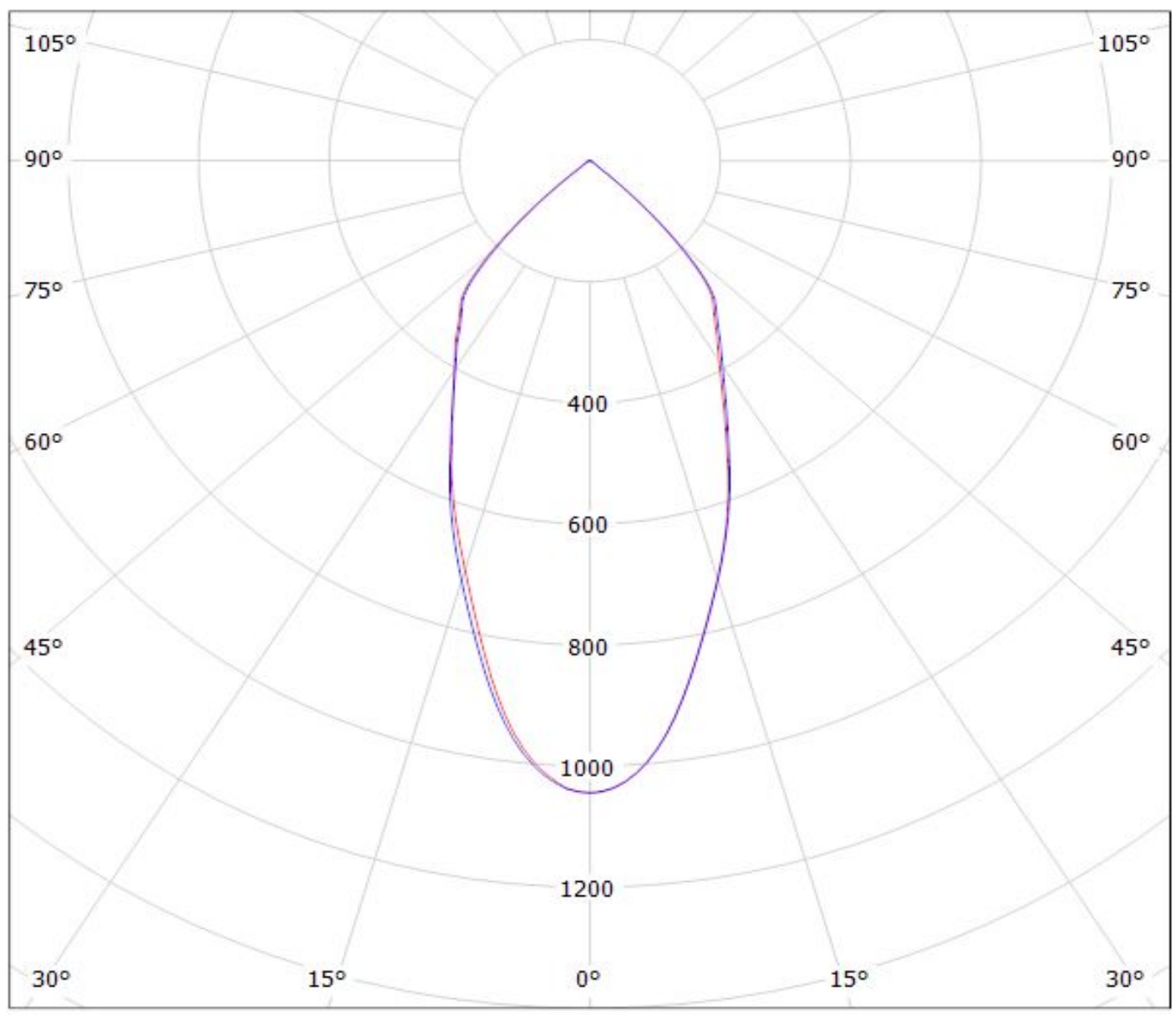

cd/klm

$\eta = 91\%$

— C0 - C180 — C90 - C270

Luminaire: Ledil FCN13693_ANGELINA-W (MJT_80W_Les22) +431TypL3

Lamps: 1 x Seoul_MJT_80W_Les22mm_(SAWx22AAA)_+_VERO29_+_431TypL3_2407.73lm@250mA_P=13.2662W_I=0.25A

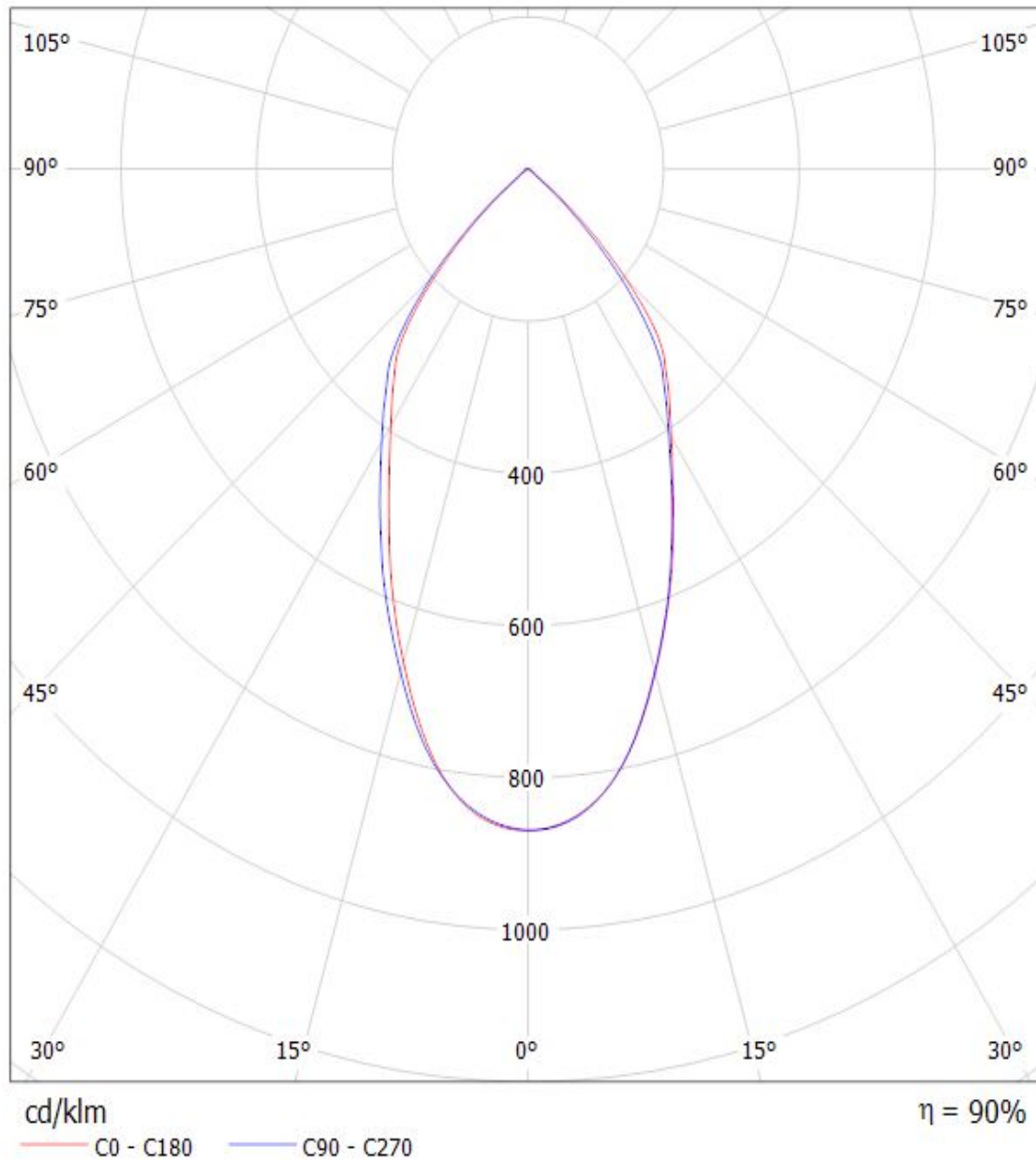

NOTE: The typical divergence will be changed by different color, chip size and chip position tolerance. The typical total divergence is the full angle measured where the luminous intensity is half of the peak value.

GENERAL INFORMATION

- Product series especially designed & optimized for series of LEDs.
- Special care taken to make light distribution as uniform as possible.

Note! Due to use of high power COB's with this product, special attention to proper thermal design is highly recommended. LEDiL has no liability for direct, indirect or consecutive damages arising from the LEDiL products being used outside of the recommended temperature range.