

ROHM Switching Regulator Solutions

Evaluation Board: Synchronous Buck Converter Integrated FET

BD9B301MUV-EVK-101 (3.3 | 3A Output)

Introduction

This application note will provide the steps necessary to operate and evaluate ROHM's synchronous buck DC/DC converter using the BD9B301MUV-EVK-101 evaluation board. Component selection, board layout recommendations, operating procedures, and application data are provided.

Description

This evaluation board has been specifically developed to evaluate ROHM's BD9B301MUV synchronous buck DC/DC converter with integrated 32mΩ Pch high-side and Nch low-side MOSFETs. Features include 3.3V output from 2.7V to 5.5V input and variable switching frequency: 1MHz (FREQ pin connected to VIN) or 2MHz (FREQ pin connected to Ground). Multiple protection circuits are also built in, including a fixed soft start circuit that prevents inrush current during startup, UVLO (Under Voltage Lock Out), and TSD (Thermal Shutdown).

An EN pin allows for simple ON/OFF control of the IC to reduce standby current consumption, while a MODE pin enables users to select Fixed Frequency PWM mode or Deep SLLM control that automatically switches between modes.

Applications

- Step-Down Power Supplies for DSPs, FPGAs, Microcontrollers, and more
- Laptop PCs/Tablet PCs/Servers
- LCD TVs
- Storage Devices (HDDs/SSDs)
- Printers, OA Equipment
- Entertainment Devices
- Distributed and Secondary Power Supplies

Evaluation Board Operating Limits and Absolute Maximum Ratings

Parameter	Symbol	Limit			Unit	Conditions
		MIN	TYP	MAX		
Supply Voltage						
BD9B301MUV	V _{CC}	2.7	—	5.5	V	
Output Voltage/Current						
BD9B301MUV	V _{OUT}	—	3.3	—	V	
	I _{OUT}	—	—	3	A	

Evaluation Board

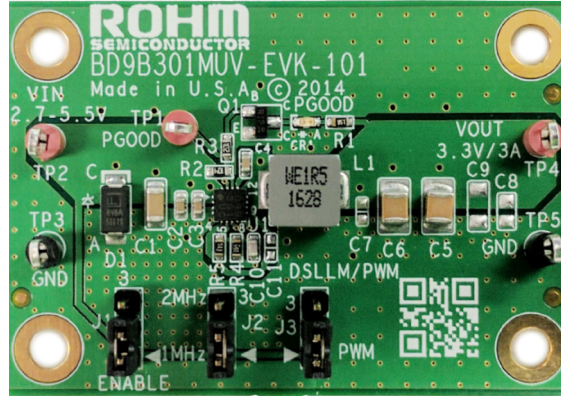
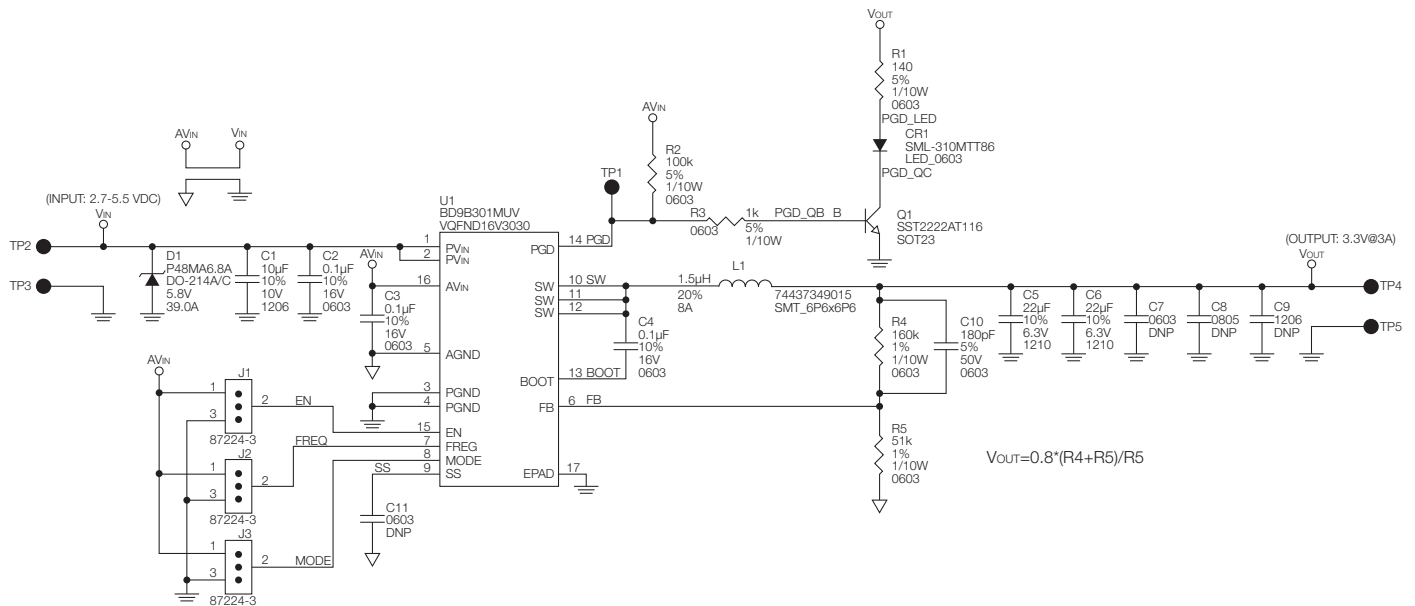

Figure 1: Evaluation Board for the BD9B301MUV

Board Schematic



BD9B301MUV EVM Jumper Positions		
Reference Designator	Position	Description
J1	2-1	Enable U1
	2-3	Disable U1
J2	2-1	Set switching frequency of U1 is 1.0MHz
	2-3	Set switching frequency of U1 is 2.0MHz
J3	2-1	Set operation mode of U1 is fixed frequency PWM mode
	2-3	Set operation mode of U1 is automatically switched between the Deep-SLLM control and fixed frequency PWM mode

Note:
 1. $0.8V \leq V_{OUT} = V \cdot 0.8 \cdot V_{IN}$

Figure 2: BD9B301MUV-EVK-101 Evaluation Board Schematic

Board I/O

Below is a reference application circuit that shows the inputs V_{IN} , Enable, FREQ and MODE and the output V_{OUT} .

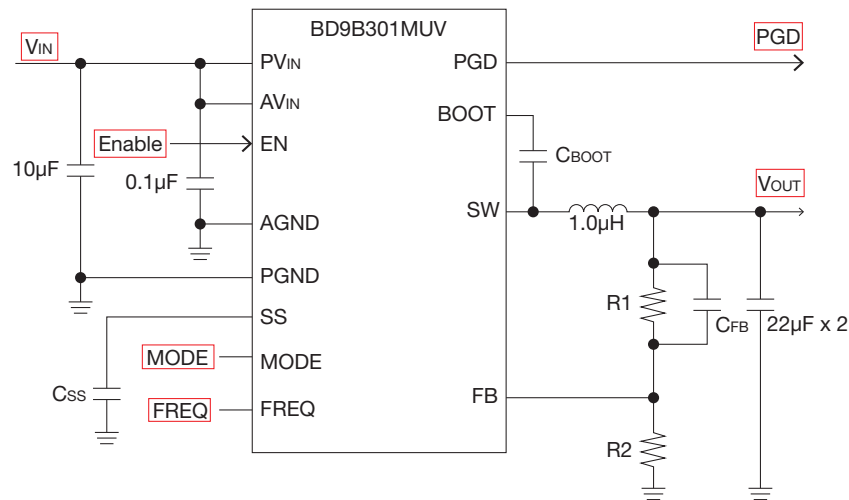

Figure 2: BD9B301MUV-EVK-101 Evaluation Board I/O

Operating Procedure

1. Connect the power supply's GND terminal to GND test point TP3 on the evaluation board.
2. Connect the power supply's V_{CC} terminal to V_{IN} test point TP2 on the evaluation board. This will provide V_{IN} to the IC U1. Please note that V_{CC} should be in the range from 2.7V to 5.5V.
3. Set the operating mode by changing the position of shunt jumper J3 (If Pin2 is connected to Pin1, the MODE pin of IC U1 will be pulled high and IC U1 will operate in Fixed frequency PWM mode, otherwise the MODE pin of IC U1 will be pulled low and IC U1 will operate by automatically switching between Deep-SLLM control and fixed frequency PWM mode).
4. Set the switching frequency by changing the position of shunt jumper J2 (If Pin2 is connected to Pin1, the FREQ pin of IC U1 will be pulled high and IC U1 will switch frequency to 1.0MHz, otherwise the FREQ pin of IC U1 will be pulled low and the the frequency will be switched to 2.0MHz).
5. Check if shunt jumper J1 is the ON position (Connect Pin 2 to Pin 1, the EN pin of IC U1 is pulled high as a default).
6. Connect the electronic load to TP4 and TP5. Do not turn on the load.
7. Turn on the power supply. The output voltage V_{OUT} (+3.3V) can be measured at the test point TP4. Now turn on the load. The load can be increased up to 3A MAX.

Reference Application Data

The following are graphs of the hot plugging test, quiescent current, efficiency, load response, and output voltage ripple response of the BD9B301MUV-EVK-101 evaluation board.

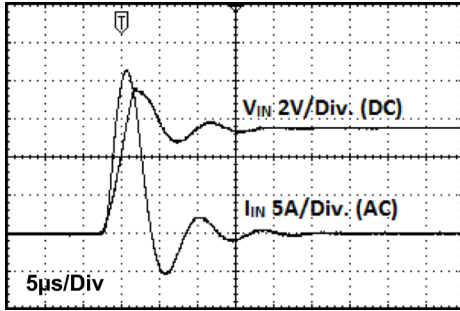

Fig 4: Hot Plug-in Test with Zener Diode P4SMA6.8A, $V_{IN}=5.5V$, $V_{OUT}=3.3V$, $I_{OUT}=3A$, $FREQ=L$, $MODE=L$

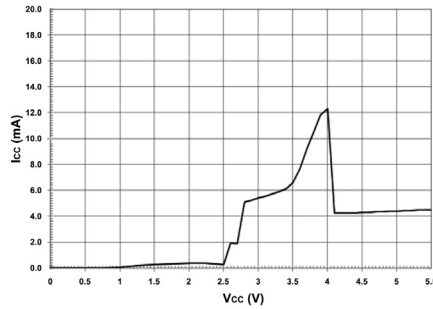

Fig 5: Circuit Current vs. Power Supply Voltage Characteristics ($Temp=25^{\circ}C$, $FREQ=L$, $MODE=L$)

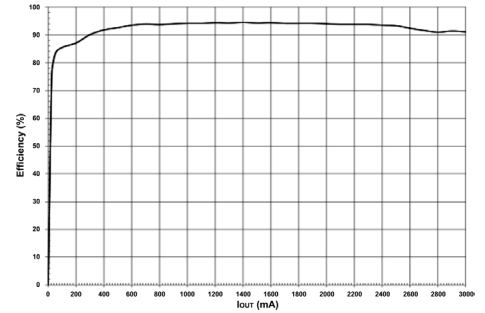

Fig 6: Electric Power Conversion Rate ($V_{OUT}=3.3V$, $FREQ=L$, $MODE=L$)

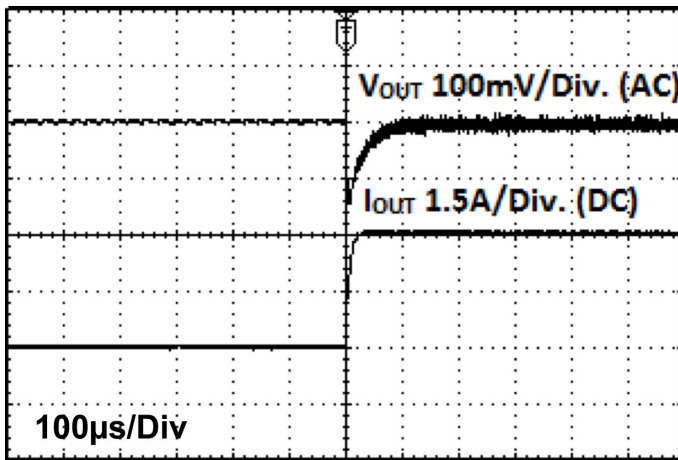

Fig 7: Load Response Characteristics ($V_{IN}=5V$, $V_{OUT}=3.3V$, $I_{OUT}=0 \rightarrow 3A$, $FREQ=L$, $MODE=L$)

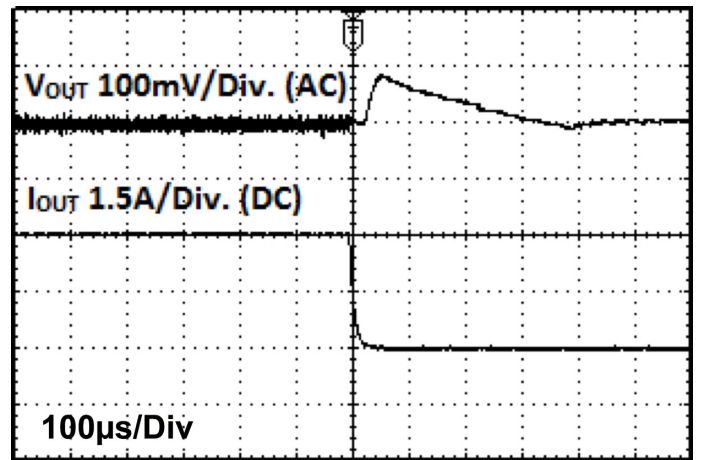

Fig 8: Load Response Characteristics ($V_{IN}=5V$, $V_{OUT}=3.3V$, $I_{OUT}=3A \rightarrow 0$, $FREQ=L$, $MODE=L$)

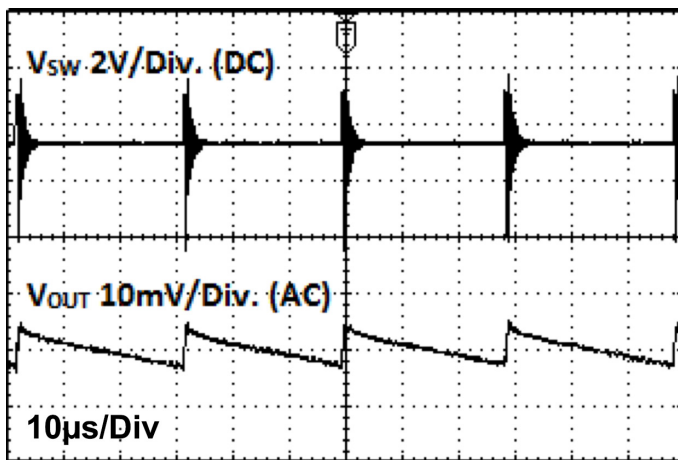

Fig 9: Output Voltage Ripple Response Characteristics ($V_{IN}=5V$, $V_{OUT}=3.3V$, $I_{OUT}=0$, $FREQ=L$, $MODE=L$)

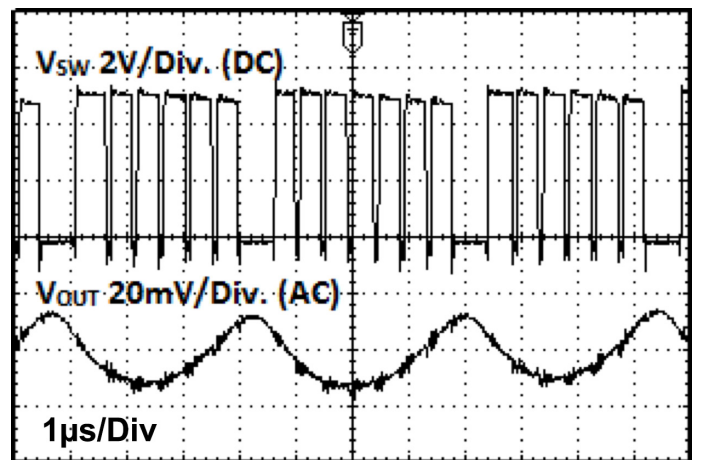

Fig 10: Output Voltage Ripple Response Characteristics ($V_{IN}=5V$, $V_{OUT}=3.3V$, $I_{OUT}=3A$, $FREQ=L$, $MODE=L$)

Typical Performance Data - continued

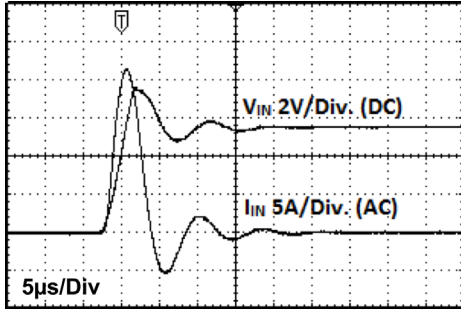

Fig 11: Hot Plug-in Test with Zener Diode P4SMA6.8A, $V_{IN}=5.5V$, $V_{OUT}=3.3V$, $I_{OUT}=3A$, FREQ=L, MODE=H

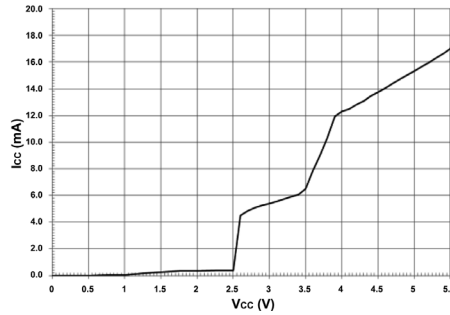

Fig 12: Circuit Current vs. Power Supply Voltage Characteristics (Temp=25°C, FREQ=L, MODE=H)

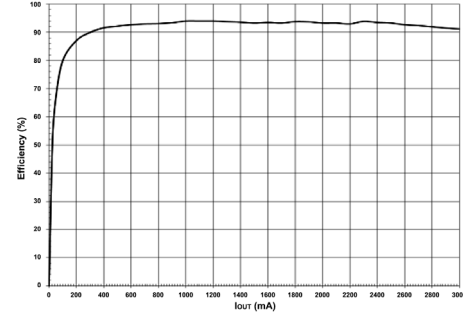

Fig 13: Electric Power Conversion Rate ($V_{OUT}=3.3V$, FREQ=L, MODE=H)

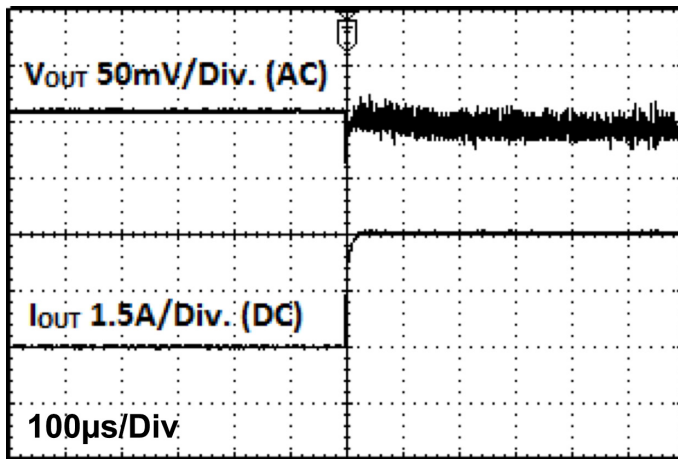

Fig 14: Load Response Characteristics ($V_{IN}=5V$, $V_{OUT}=3.3V$, $I_{OUT}=0 \rightarrow 3A$, FREQ=L, MODE=H)

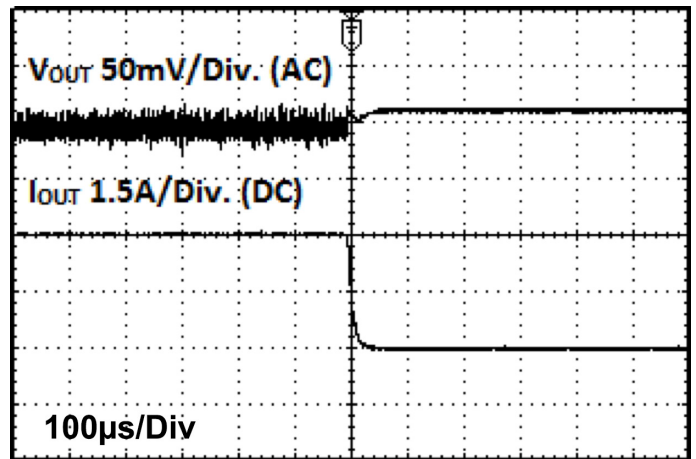

Fig 15: Load Response Characteristics ($V_{IN}=5V$, $V_{OUT}=3.3V$, $I_{OUT}=3A \rightarrow 0$, FREQ=L, MODE=H)

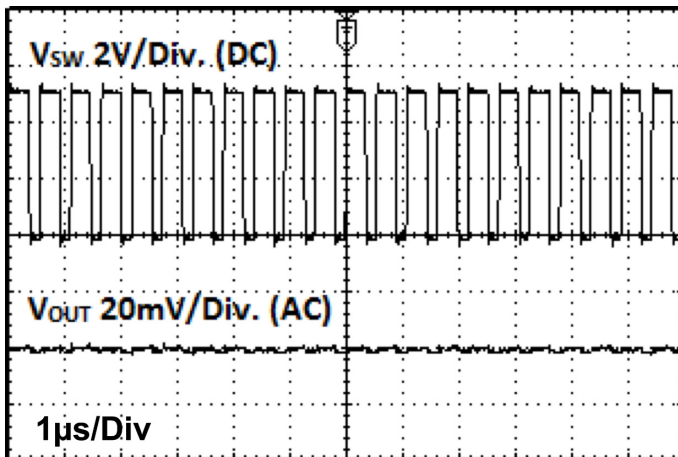

Fig 16: Output Voltage Ripple Response Characteristics ($V_{IN}=5V$, $V_{OUT}=3.3V$, $I_{OUT}=0$, FREQ=L, MODE=H)

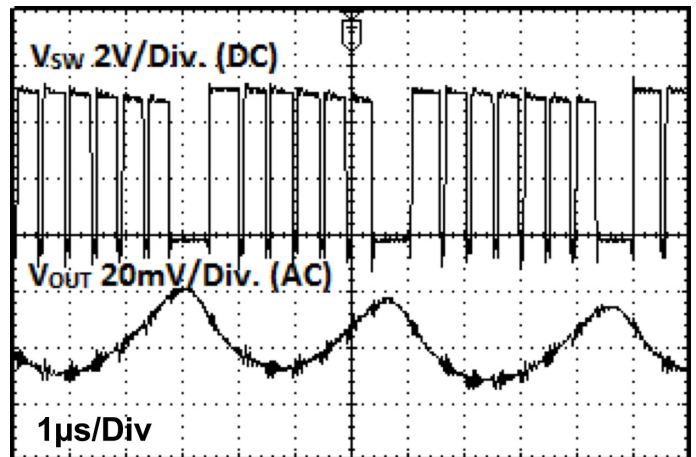

Fig 17: Output Voltage Ripple Response Characteristics ($V_{IN}=5V$, $V_{OUT}=3.3V$, $I_{OUT}=3A$, FREQ=L, MODE=H)

Typical Performance Data - continued

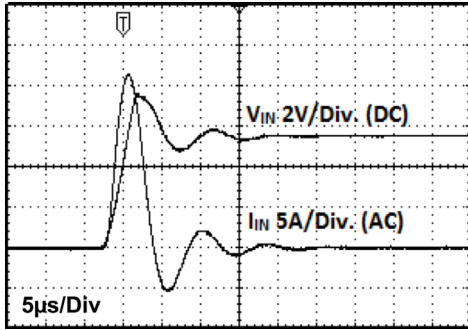

Fig 18: Hot Plug-in Test with Zener Diode P4SMA6.8A, VIN=5.5V, VOUT=3.3V, IOUT=3A, FREQ=H, MODE=L

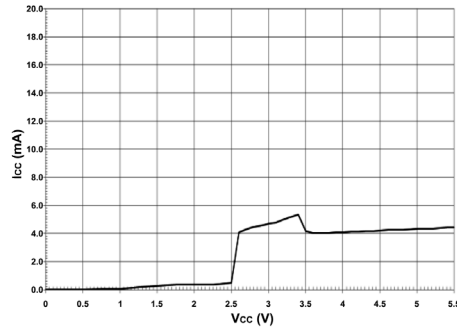

Fig 19: Circuit Current vs. Power Supply Voltage Characteristics (Temp=25°C, FREQ=H, MODE=L)

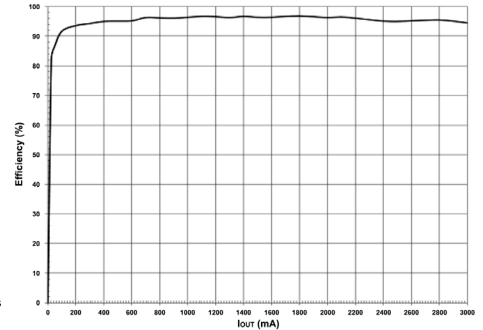

Fig 20: Electric Power Conversion Rate (VOUT=3.3V, FREQ=H, MODE=L)

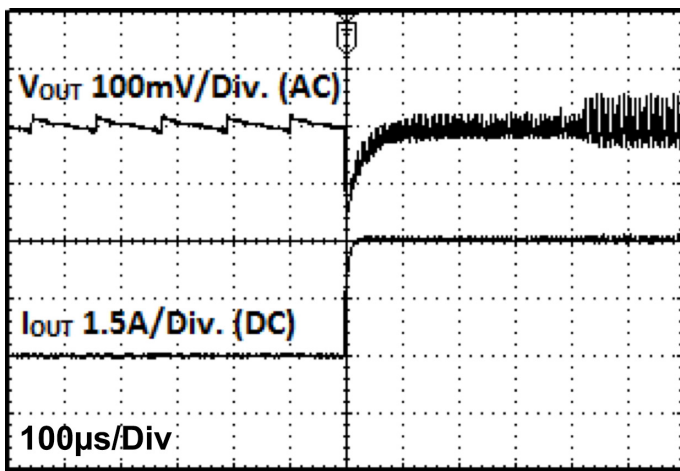

Fig 21: Load Response Characteristics (VIN=5V, VOUT=3.3V, IOUT=0 → 3A, FREQ=H, MODE=L)

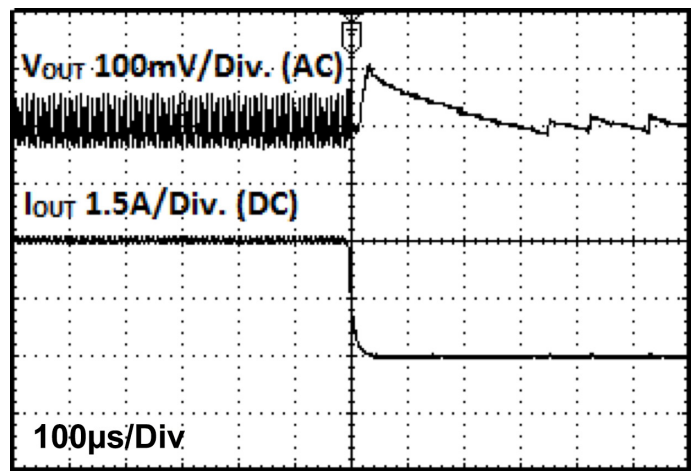

Fig 22: Load Response Characteristics (VIN=5V, VOUT=3.3V, IOUT=3A → 0, FREQ=H, MODE=L)

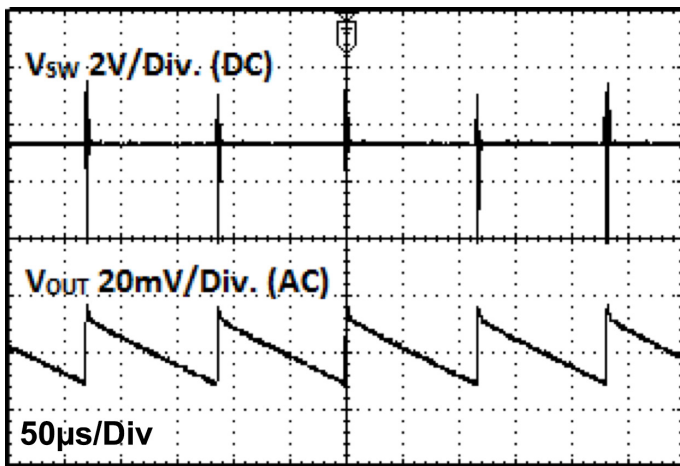

Fig 23: Output Voltage Ripple Response Characteristics (VIN=5V, VOUT=3.3V, IOUT=0, FREQ=H, MODE=L)

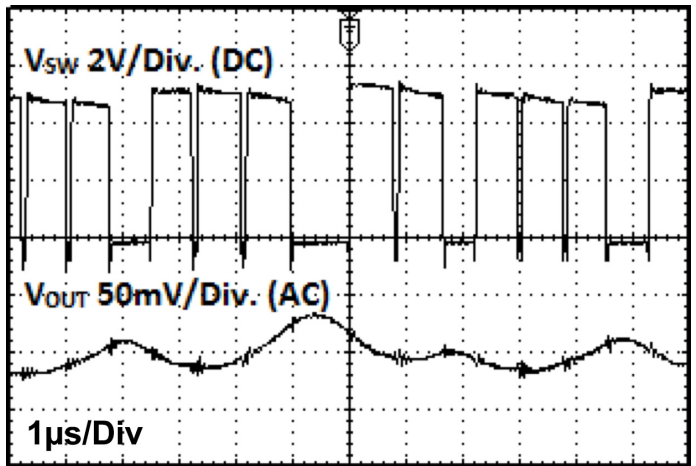

Fig 24: Output Voltage Ripple Response Characteristics (VIN=5V, VOUT=3.3V, IOUT=3A, FREQ=H, MODE=L)

Typical Performance Data - continued

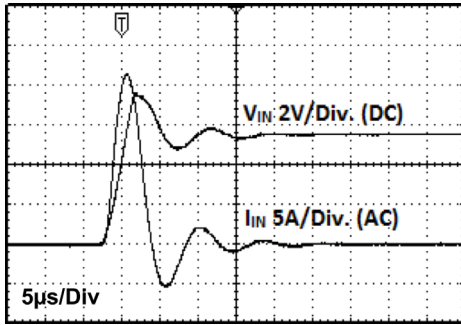

Fig 25: Hot Plug-in Test with Zener Diode P4SMA6.8A, $V_{IN}=5.5V$, $V_{OUT}=3.3V$, $I_{OUT}=3A$, FREQ=H, MODE=H

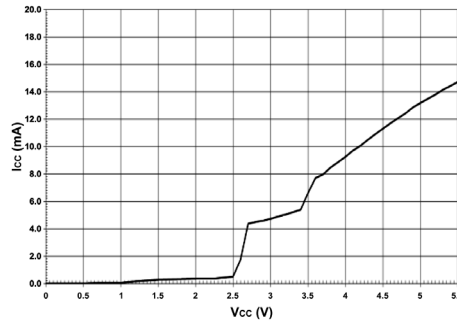

Fig 26: Circuit Current vs. Power Supply Voltage Characteristics (Temp=25°C, FREQ=H, MODE=H)

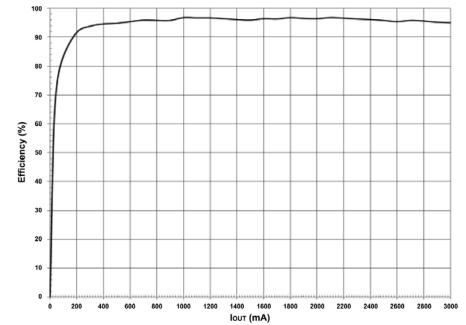

Fig 27: Electric Power Conversion Rate ($V_{OUT}=3.3V$, FREQ=H, MODE=H)

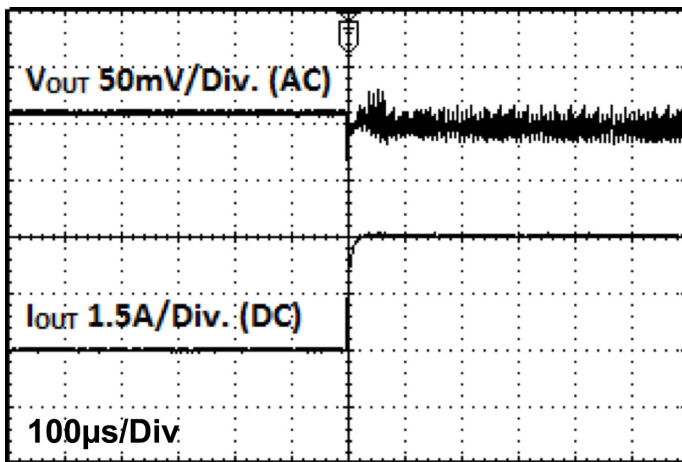

Fig 28: Load Response Characteristics ($V_{IN}=5V$, $V_{OUT}=3.3V$, $I_{OUT}=0 \rightarrow 3A$, FREQ=H, MODE=H)

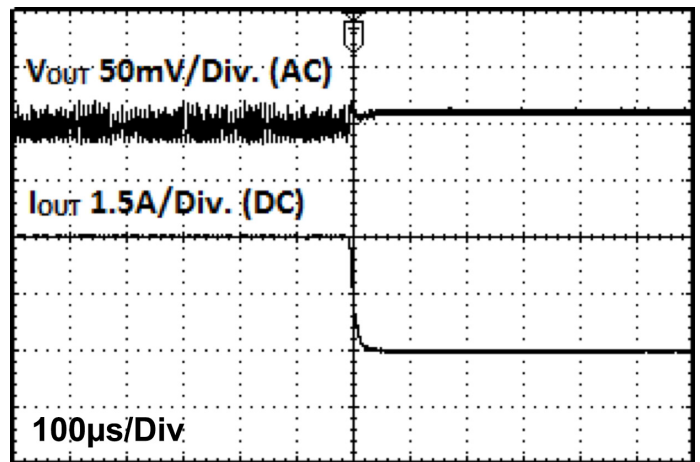

Fig 29: Load Response Characteristics ($V_{IN}=5V$, $V_{OUT}=3.3V$, $I_{OUT}=3A \rightarrow 0$, FREQ=H, MODE=H)

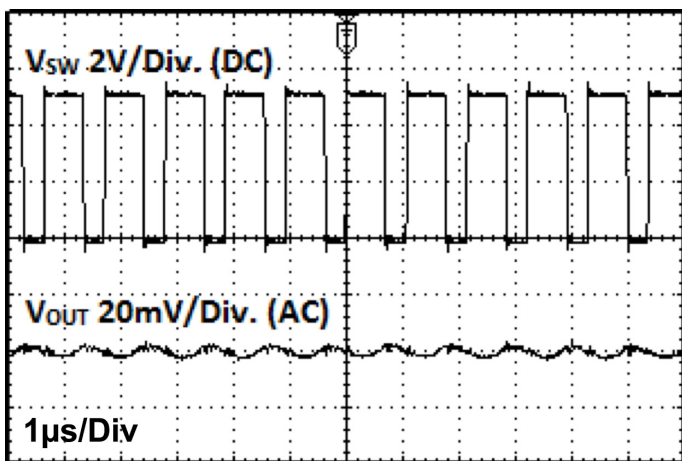

Fig 30: Output Voltage Ripple Response Characteristics ($V_{IN}=5V$, $V_{OUT}=3.3V$, $I_{OUT}=0$, FREQ=H, MODE=H)

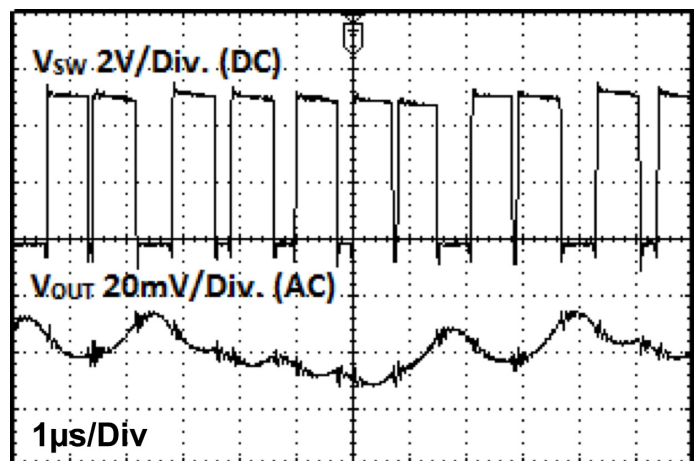

Fig 31: Output Voltage Ripple Response Characteristics ($V_{IN}=5V$, $V_{OUT}=3.3V$, $I_{OUT}=3A$, FREQ=H, MODE=H)

Evaluation Board Layout Guidelines

In the step-down DC/DC converter, a large pulse current flows through two loops. The first loop is the one into which current flows when the High-Side FET is turned ON. The flow starts from the input capacitor C_{IN} , runs through the FET, inductor L , and output capacitor C_{OUT} , then back to the GND of C_{IN} via the GND of C_{OUT} . In the second loop current flows when the Low-Side FET is turned on. The flow starts from the Low-Side FET, runs through the inductor L and output capacitor C_{OUT} , then back to the GND of the Low-Side FET via the GND of C_{OUT} . We recommend routing these two loops as thick and as short as possible to minimize noise and improve efficiency. The input and output capacitors should be connected directly to the GND plane. Please note that the PCB layout has a large influence on the DC/DC converter in terms of heat generation, noise, and efficiency.

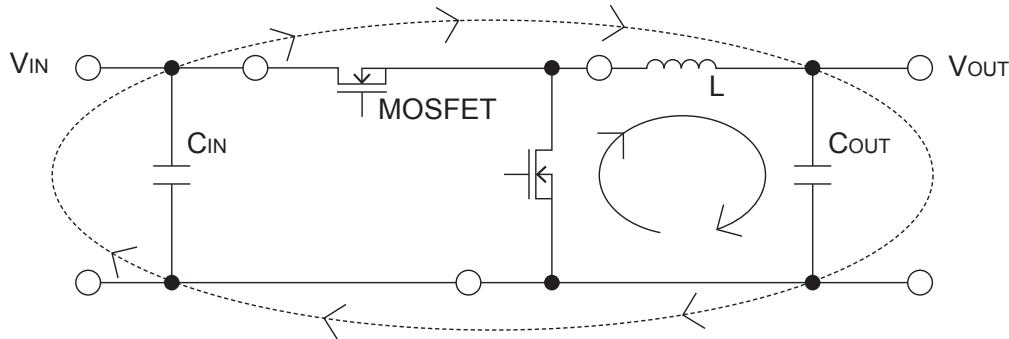

Fig 32: Current Loops of Buck Regulator System

Accordingly, when designing the PCB layout please consider the following points.

- Connect an input capacitor as close as possible to the IC PVIN terminal on the same plane as the IC.
- If there is any unused area on the PCB, provide a copper foil plane for the GND node to assist heat dissipation from the IC and the surrounding components.
- Switching nodes such as SW are susceptible to noise due to AC coupling with other nodes. Therefore, route the coil pattern as thick and as short as possible.
- Ensure that lines connected to FB are far from the SW nodes.
- Place the output capacitor away from the input capacitor in order to avoid the effects of harmonic noise from the input.

Power Dissipation

When designing the PCB layout and peripheral circuitry, sufficient consideration must be given to ensure that the power dissipation is within the allowable dissipation curve.

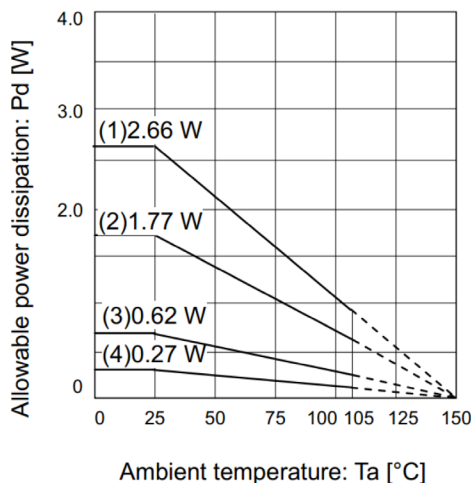

1. 4-layer board (surface heat dissipation copper foil 5505 mm²)
(Copper foil laminated on each layer)
 $\theta_{JA} = 47.0^{\circ}\text{C/W}$
2. 4-layer board (surface heat dissipation copper foil 6.28 mm²)
(Copper foil laminated on each layer)
 $\theta_{JA} = 70.62^{\circ}\text{C/W}$
3. 1-layer board (surface heat dissipation copper foil 6.28 mm²)
 $\theta_{JA} = 201.6^{\circ}\text{C/W}$
4. IC only
 $\theta_{JA} = 462.9^{\circ}\text{C/W}$

Fig 33: Thermal Derating Characteristics

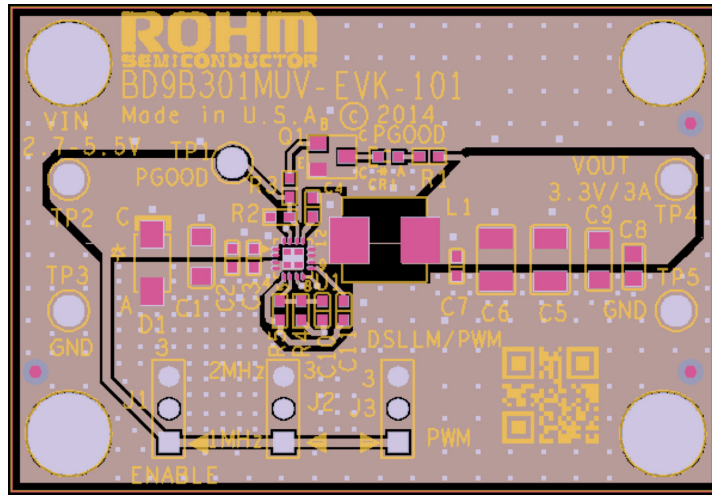

Fig 34: BD9B301MUV-EVK-101 Board PCB layout

Application Circuit Component Selection Inductor (L)

The inductance significantly depends on the output ripple current. As shown by following equation, the ripple current decreases as the inductor and/or switching frequency increases.

$$\Delta I_L = \frac{(V_{IN} - V_{OUT}) \times V_{OUT}}{L \times V_{IN} \times f}$$

Where f=Switching Frequency, L=Inductance, and ΔL=Inductor Ripple Current.

As a minimum requirement, the DC current rating of the inductor should be equal to the maximum load current plus half of the inductor ripple current as shown by the equation below.

$$I_{LPEAK} = I_{OUTMAX} + \frac{\Delta I_L}{2}$$

Evaluation Board BOM

Below is a table showing the bill of materials. Part numbers and supplier references are also provided.

No.	Qty.	Reference	Description	Manufacturer	Part No.
1	1	CR1	LED 570NM GREEN WTR CLR 0603 SMD	ROHM	SML-310MTT86
2	1	C1	CAP CER 10 μ F 10V 10% X5R 1206	Murata	GRM319R61A106KE19D
3	3	C2, C3, C4	CAP CER 0.1 μ F 16V 10% X7R 0603	Murata	GRM188R71C104KA01D
4	2	C5, C6	CAP CER 22 μ F 6.3V 10% X5R 1210	Murata	GRM32DR60J226KA01L
5	1	C10	CAP CER 180PF 50V 5% NP0 0603	Murata	GRM1885C1H181JA01D
6	1	D1	DIODE TVS 400W 6.8V UNI 5% SMD	Littlefuse Inc.	P4SMA6.8A
7	3	J1, J2, J3	CONN HEADER VERT .100 3POS 15AU	TE Connectivity	87224-3
8	1	L1	INDUCTOR WW 1.5 μ H 8A SMD	Würth	74437349015
9	1	Q1	TRANSISTOR NPN 40V 0.6A SOT-23	ROHM	SST2222AT116
10	1	R1	RES 140 OHM 1/10W 1% 0603 SMD	ROHM	MCR03ERTF1400
11	1	R2	RES 100K OHM 1/10W 5% 0603 SMD	ROHM	MCR03ERTJ104
12	1	R3	RES 1K OHM 1/10W 5% 0603 SMD	ROHM	MCR03ERTJ102
13	1	R4	RES 160K OHM 1/10W 1% 0603 SMD	ROHM	MCR03ERTF1603
14	1	R5	RES 51K OHM 1/10W 1% 0603 SMD	ROHM	MCR03ERTF5102
15	3	TP1, TP2, TP4	TEST POINT PC MULTI PURPOSE RED	Keystone Electronics	5010
16	2	TP3, TP5	TEST POINT PC MULTI PURPOSE BLK	Keystone Electronics	5011
17	1	U1	DCDC Converter	ROHM	BD9B301MUV
18	3		Shunt jumper for header J1, J2, J3 (item #7), CONN SHUNT 2POS GOLD W/HANDLE	TE Connectivity	881545-1

Notes

1. The information contained herein is subject to change without notice.
2. Before you use our Products, please contact a sales representative and verify the latest specifications.
3. Although ROHM is continuously working to improve product reliability and quality, semiconductors can break down and malfunction due to various factors.
Therefore, in order to prevent personal injury or fire arising from failure, please take safety measures such as complying with the derating characteristics, implementing redundant and fire prevention designs, and utilizing backups and fail-safe procedures. ROHM shall have no responsibility for any damages arising out of the use of our Products beyond the rating specified by ROHM.
4. Examples of application circuits, circuit constants and any other information contained herein are provided only to illustrate the standard usage and operations of the Products. The peripheral conditions must be taken into account when designing circuits for mass production.
5. The technical information specified herein is intended only to show the typical functions and examples of application circuits for the Products. ROHM does not grant you, explicitly or implicitly, any license to use or exercise intellectual property or other rights held by ROHM or any other parties. ROHM shall have no responsibility whatsoever for any dispute arising out of the use of such technical information.
6. The Products specified in this document are not designed to be radiation tolerant.
7. When using our Products in applications requiring a high degree of reliability (as exemplified below), please contact and consult with a ROHM representative : transportation equipment (i.e. cars, ships, trains), primary communication equipment, traffic lights, fire/crime prevention, safety equipment, medical systems, servers, solar cells, and power transmission systems.
8. Do not use our Products in applications requiring extremely high reliability, such as aerospace equipment, nuclear power control systems, and submarine repeaters.
9. ROHM shall bear no responsibility for any damages or injury arising from non-compliance with the recommended usage conditions and specifications contained herein.
10. ROHM has used reasonable care to ensure the accuracy of the information contained in this document. However, ROHM does not warrants that such information is error-free, and ROHM shall have no responsibility for any damages arising from any inaccuracy or misprint of such information.
11. Please use the Products in accordance with any applicable environmental laws and regulations, such as the RoHS Directive. For more details, including RoHS compatibility, please contact a ROHM sales office. ROHM shall bear no responsibility for any damages or losses resulting from non-compliance with any applicable laws or regulations.
12. When providing our Products and technologies contained in this document to other countries, you must abide by the procedures and provisions stipulated in all applicable export laws and regulations, including without limitation the US Export Administration Regulations and the Foreign Exchange and Foreign Trade Act.
13. This document, in part or in whole, may not be reprinted or reproduced without the prior consent of ROHM.



Thank you for your interest in ROHM products.
Please contact us for additional information and product catalogs.

ROHM Customer Support System

www.rohm.com/contact