

TMCC160 CANopen[®] Firmware Manual

Firmware Version V3.00 | Document Revision V1.00 • 2017-Aug-29

The CANopen Firmware is used in combination with the integrated TMCC160 motionCookie™ microsystem with 3-Phase BLDC/PMSM gate driver for up to 24V and 1A gate current.

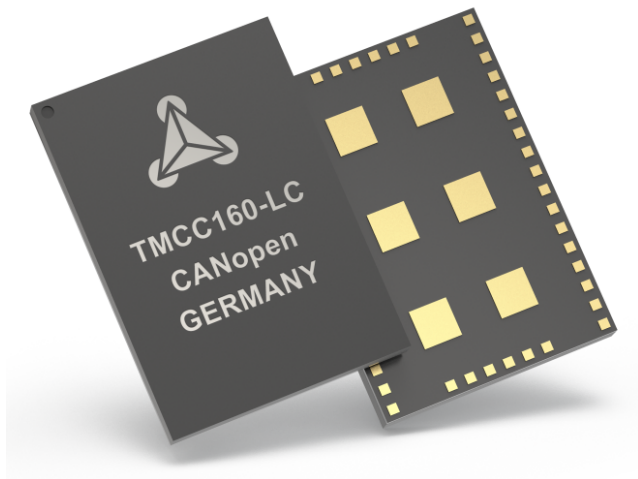

Features

- Single axis field oriented control for BLDC/PMSM motor
- Digital Hall and ABN encoder support
- 28V DC supply voltage
- RS232/RS485 & CAN interface
- CANopen CiA 402 drive profile for Torque, Velocity, and Position control

Applications

- Life Sciences
- Test & Measurement
- Robotics / Automation

Simplified Block Diagram

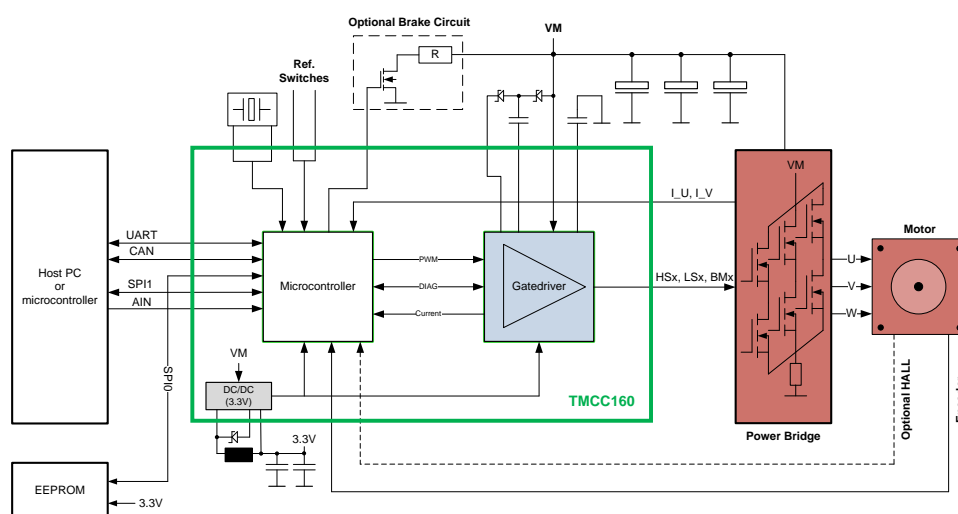

©2017 TRINAMIC Motion Control GmbH & Co. KG, Hamburg, Germany
 Terms of delivery and rights to technical change reserved.
 Download newest version at: www.trinamic.com



Read entire documentation.

Contents

1	Preface	5
1.1	General Features of this CANopen Implementation	5
1.2	Abbreviations used in this Manual	7
1.3	Firmware Update	7
2	Communication	8
2.1	Reference Model	8
2.2	NMT State Machine	10
2.3	Device Model	11
2.4	Object Dictionary	12
3	Communication area	13
3.1	Detailed object specifications	13
3.1.1	Object 1000 _h : Device Type	13
3.1.2	Object 1001 _h : Error Register	13
3.1.3	Object 1005 _h : COB-ID SYNC Message	14
3.1.4	Object 1008 _h : Manufacturer Device Name	15
3.1.5	Object 1009 _h : Manufacturer Hardware Version	15
3.1.6	Object 100A _h : Manufacturer Software Version	15
3.1.7	Object 100C _h : Guard Time	16
3.1.8	Object 100D _h : Life Time Factor	16
3.1.9	Object 1010 _h : Store Parameters	17
3.1.10	Object 1011 _h : Restore Parameters	18
3.1.11	Object 1014 _h : COB-ID Emergency Object	19
3.1.12	Object 1015 _h : Inhibit Time EMCY	19
3.1.13	Object 1016 _h : Consumer Heartbeat Time	20
3.1.14	Object 1017 _h : Producer Heartbeat Time	20
3.1.15	Object 1018 _h : Identity Object	21
3.1.16	Object 1029 _h : Error Behaviour	21
3.1.17	Objects 1400 _h – 1403 _h : Receive PDO Communication Parameter	22
3.1.18	Objects 1600 _h – 1603 _h : Receive PDO Mapping Parameter	23
3.1.19	Objects 1800 _h – 1803 _h : Transmit PDO Communication Parameter	24
3.1.20	Objects 1A00 _h – 1A03 _h : Transmit PDO Mapping Parameter	25
4	Manufacturer specific area	26
4.1	Detailed object specifications	26
4.1.1	Object 200D _h : Status Flags	26
4.1.2	Object 200E _h : Supply Voltage	27
4.1.3	Object 200F _h : Driver Temperatur	28
4.1.4	Object 2010 _h : Motor Settings	28
4.1.5	Object 2020 _h : Limits	29
4.1.6	Object 2030 _h : Torque Mode Settings	29
4.1.7	Object 2040 _h : Velocity Mode Settings	30
4.1.8	Object 2050 _h : Position Mode Settings	30
4.1.9	Object 2055 _h : Commutation Mode	31
4.1.10	Object 2056 _h : Velocity Ramp Mode	31
4.1.11	Object 2060 _h : Open Loop Settings	32
4.1.12	Object 2070 _h : Hall Sensor Settings	32
4.1.13	Object 2080 _h : ABN Encoder Settings	33
4.1.14	Object 2090 _h : Brake Chopper Settings	33
4.1.15	Object 2095 _h : IIT Settings	34
4.1.16	Object 2100 _h : Home Offset Display	34



4.1.17	Object 2702 _h : Digital Inputs	34
4.1.18	Object 2704 _h : CAN Bit Rate	35
4.1.19	Object 2705 _h : Node ID	35
4.1.20	Object 2706 _h : Store	36
4.1.21	Object 2707 _h : CAN Bit Rate Load	36
4.1.22	Object 2708 _h : Node ID Load	37
4.1.23	Object 270E _h : Analog Inputs	37
5	Profile specific area	38
5.1	Detailed object specifications	38
5.1.1	Object 605A _h : Quick Stop Option Code	38
5.1.2	Object 605B _h : Shutdown Option Code	39
5.1.3	Object 605C _h : Disable Operation Option Code	39
5.1.4	Object 605D _h : Halt Option Code	40
5.1.5	Object 605E _h : Fault Reaction Option Code	40
5.1.6	Object 6060 _h : Modes of Operation	41
5.1.7	Object 6061 _h : Modes of Operation Display	41
5.1.8	Object 608F _h : Position Encoder Resolution	42
5.1.9	Object 6099 _h : Homing Speeds	42
5.1.10	Object 60FD _h : Digital Inputs	43
5.1.11	Object 6502 _h : Supported Drive Modes	43
6	Profile Position Mode	44
6.1	Detailed Object Specifications	44
6.2	Detailed Object Specifications	45
6.2.1	Object 6040 _h : Control Word	45
6.2.2	Object 6041 _h : Status Word	47
6.2.3	Object 6062 _h : Position Demand Value	48
6.2.4	Object 6063 _h : Position Actual Internal Value	49
6.2.5	Object 6064 _h : Position Actual Value	49
6.2.6	Object 6067 _h : Position Window	50
6.2.7	Object 606C _h : Velocity Actual Value	50
6.2.8	Object 607A _h : Target Position	50
6.2.9	Object 607D _h : Software Position Limit	51
6.2.10	Object 6081 _h : Profile Velocity (pp)	51
6.2.11	Object 6082 _h : End Velocity	52
6.2.12	Object 6083 _h : Profile Acceleration	52
6.2.13	Object 6084 _h : Profile Deceleration	53
6.2.14	Object 6085 _h : Quick Stop Deceleration	53
6.3	How to move a Motor in pp Mode	54
7	Profile Velocity Mode	55
7.1	Detailed Object Specifications	55
7.1.1	Object 6040 _h : Control Word	55
7.1.2	Object 6041 _h : Status Word	56
7.1.3	Object 6062 _h : Position Demand Value	58
7.1.4	Object 6063 _h : Position Actual Internal Value	58
7.1.5	Object 6064 _h : Position Actual Value	59
7.1.6	Object 606C _h : Velocity Actual Value	59
7.1.7	Object 607D _h : Software Position Limit	59
7.1.8	Object 6083 _h : Profile Acceleration	60
7.1.9	Object 6085 _h : Quick Stop Deceleration	60
7.1.10	Object 60FF _h : Target Velocity	61
7.2	How to move a Motor in pv Mode	62



8 Homing mode	63
8.1 Homing Methods	64
8.1.1 Homing Method 17 and 18: Homing without Index Pulse	64
8.1.2 Homing Method 35: Current Position as Home Position	64
8.2 Detailed Object Specifications	65
8.2.1 Object 6040 _h : Control Word	65
8.2.2 Object 6041 _h : Status Word	66
8.2.3 Object 606C _h : Velocity Actual Value	67
8.2.4 Object 607C _h : Home Offset	68
8.2.5 Object 6098 _h : Homing Method	68
8.2.6 Object 6099 _h : Homing Speeds	69
8.2.7 Object 609A _h : Homing Acceleration	69
8.2.8 Object 2100 _h : Home Offset Display	70
8.3 How to start a Homing in hm Mode	71
9 Cyclic synchronous Torque Mode	72
9.1 Detailed Object Specifications	72
9.1.1 Object 6040 _h : Control Word	72
9.1.2 Object 6041 _h : Status Word	73
9.1.3 Object 6071 _h : Target Torque	74
9.1.4 Object 6077 _h : Torque Actual Value	75
9.1.5 Object 60B2 _h : Torque offset	75
9.2 How to move a Motor in cst Mode	77
10 Emergency Messages (EMCY)	78
11 Figures Index	80
12 Tables Index	81
13 Supplemental Directives	84
13.1 Producer Information	84
13.2 Copyright	84
13.3 Trademark Designations and Symbols	84
13.4 Target User	84
13.5 Disclaimer: Life Support Systems	84
13.6 Disclaimer: Intended Use	84
13.7 Collateral Documents & Tools	85
14 Revision History	86
14.1 Firmware Revision	86
14.2 Document Revision	86



1 Preface

This document specifies objects and modes of operation of the Trinamic TMCC160 BLDC/PMSM motor control module with CANopen firmware. The CANopen firmware is designed to fulfill the CANopen DS402 and DS301 standards. This manual assumes that the reader is already familiar with the basics of the CANopen protocol, defined by the DS301 and DS402 standards of the CAN-CiA.

If necessary, it is always possible to turn the module into a TMCL module by loading the TMCC160 TMCL firmware again with the help of the firmware update function of the TMCL-IDE 3.0 and the RS232/RS485 interface.

1.1 General Features of this CANopen Implementation

Main Characteristics

- Communication according to standard CiA-301 V4.1
- CAN bit rate: 20...1000kBit/s
- CAN ID: 11 bit
- Node ID: 1...127 (use vendor specific objects for changing the node ID)
- NMT services: NMT slave

SDO Communication

- 1 server
- Expedited transfer
- Segmented transfer
- No block transfer

PDO Communication

- Producer
- Consumer
- RPDOs
 - Axis 0: 1, 2, 3, 4
 - Transmission modes: asynchronous.
 - Dynamic mapping with max. 3 mapping entries.
 - Default mappings: according to CiA-402 for first three PDOs of each axis, manufacturer specific for other PDOs of each axis.
- TPDOs
 - Axis 0: 1, 2, 3, 4
 - Transmission modes: asynchronous, asynchronous with event timer, synchronous.
 - Dynamic mapping with max. 3 mapping entries.
 - Default mappings: according to CiA-402 for first three PDOs of each axis, manufacturer specific for other PDOs of each axis.



Further Characteristics

- SYNC: consumer (TPDOs 3 are synchronous PDOs)
- Emergency: producer
- RTR: supported only for node guarding/life guarding
- Heartbeat: consumer and producer



1.2 Abbreviations used in this Manual

Abbreviations	
CAN	Controller area network
CHGND	chassis ground / earth ground
COB	Communication object
FSA	Finite state automaton
FSM	Finite state machine
NMT	Network management
ID	Identifier
LSB	Least significant bit
MSB	Most significant bit
PDO	Process data object
PDS	Power drive system
RPDO	Receive process data object
SDO	Service data object
TPDO	Transmit process data object
EMCY	Emergency object
rw	Read and write
ro	Read only
hm	Homing mode
pp	Profile position mode
pv	Profile velocity mode
vm	Velocity mode

Table 1: Abbreviations used in this Manual

1.3 Firmware Update

The software running on the microprocessor consists of two parts, a bootloader and the CANopen firmware itself. Whereas the bootloader is installed during production and testing at TRINAMIC and remains untouched throughout the whole lifetime, the CANopen firmware can easily be updated by the user. The new firmware can be loaded into the module via the firmware update function of the TMCL-IDE, using the RS232/RS485 interface of the module.



2 Communication

2.1 Reference Model

The application layer comprises a concept to configure and communicate real-time-data as well as the mechanisms for synchronization between devices. The functionality which the application layer offers to an application is logically divided over different service data objects (SDO) in the application layer. A service object offers a specific functionality and all the related services.

Applications interact by invoking services of a service object in the application layer. To realize these services this object exchanges data via the CAN Network with peer service object(s) using a protocol.

The application and the application layer interact with service primitives.

Service Primitives	
Primitive	Definition
Request	Issued by the application to the application layer to request a service.
Indication	Issued by the application layer to the application to report an internal event detected by the application layer or indicate that a service is requested.
Response	Issued by the application to the application layer to respond to a previous received indication.
Confirmation	Issued by the application layer to the application to report the result of a previously issued request.

Table 2: Service Primitives

A service type defines the primitives that are exchanged between the application layer and the cooperating applications for a particular service of a service object. Unconfirmed and confirmed services are collectively called remote services.



Service Types	
Type	Definition
Local service	Involves only the local service object. The application issues a request to its local service object that executes the requested service without communicating with peer service object(s).
Unconfirmed service	Involves one or more peer service objects. The application issues a request to its local service object. This request is transferred to the peer service object(s) that each passes it to their application as an indication. The result is not confirmed back.
Confirmed service	Can involve only one peer service object. The application issues a request to its local service object. This request is transferred to the peer service object that passes it to the other application as an indication. The other application issues a response that is transferred to the originating service object that passes it as a confirmation to the requesting application.
Provider initiated service	Involves only the local service object. The service object (being the service provider) detects an event not solicited by a requested service. This event is then indicated to the application.

Table 3: Service Types



2.2 NMT State Machine

The finite state machine (FSM) or simply state machine is a model of behavior composed of a finite number of states, transitions between those states, and actions. It shows which way the logic runs when certain conditions are met.

Starting and resetting the device is controlled via the state machine. The NMT state machine consists of the states shown in figure 1.

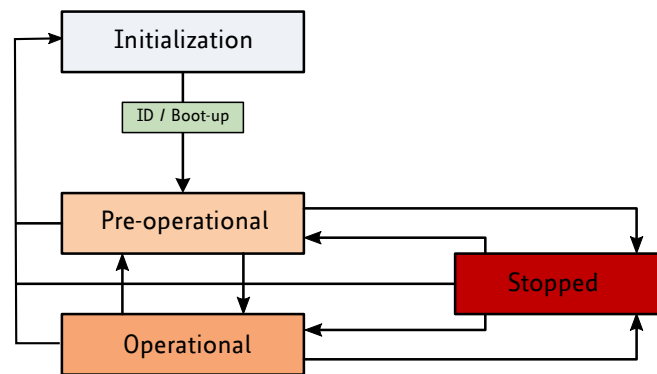

Figure 1: NMT State Machine

After power-on or reset the device enters the Initialization state. After the device initialization is finished, the device automatically transits to the **Pre-operational** state and indicates this state transition by sending the boot-up message. This way the device indicates that it is ready to work. A device that stays in Pre-operational state may start to transmit SYNC-, time stamp- or heartbeat message. In contrast to the PDO communication that is disabled in this state, the device can communicate via SDO.

The PDO communication is only possible within the **Operational** state. During Operational state the device can use all supported communication objects.

A device that was switched to the **Stopped** state only reacts on received NMT commands. In addition the device indicates the current NMT state by supporting the error control protocol during Stopped state.

The transitions between states are made by issuing a network management (NMT) communication object to the device. The NMT protocols are used to generate state machine change commands (e.g. to start and stop the device), detect remote device boot-ups and error conditions.

The Heartbeat message of a CANopen device contains the device status of the NMT state machine and is sent cyclically by the CANopen device.

The NMT state machine (or DS301 state machine) is not to be confused with the DS402 state machine. There is only one NMT state machine for the entire device, but for each motor there is a DS402 state machine which controls the motor. There are no links between these state machines, with one exception: When the NMT state machine is being switched to the stopped state, all DS402 state machines that are in OPERATION_ENABLED state will be switch to FAULT state.



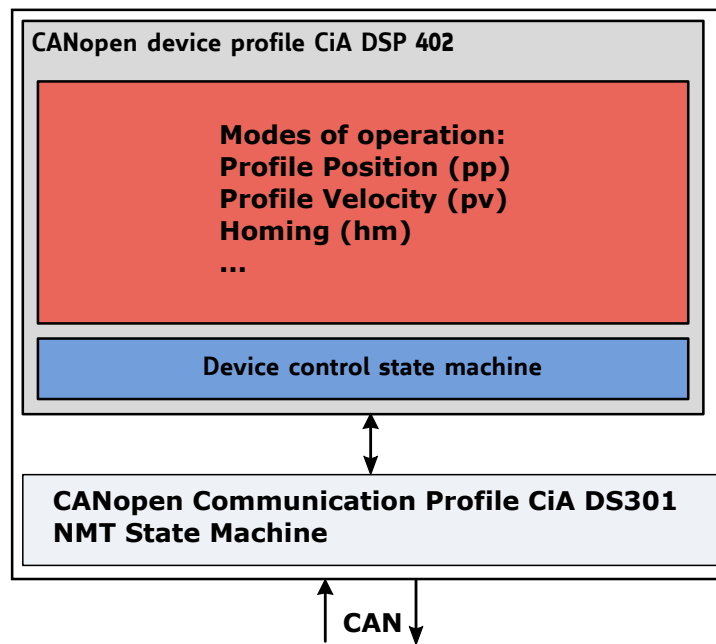

Figure 2: Communication Architecture

2.3 Device Model

A CANopen device mainly consists of the following parts:

- *Communication*: This function unit provides the communication objects and the appropriate functionality to transport data items via the underlying network structure.
- *Object dictionary*: The object dictionary is a collection of all the data items which have an influence on the behavior of the application objects, the communication objects and the state machine used on this device.
- *Application*: The application comprises the functionality of the device with respect to the interaction with the process environment.



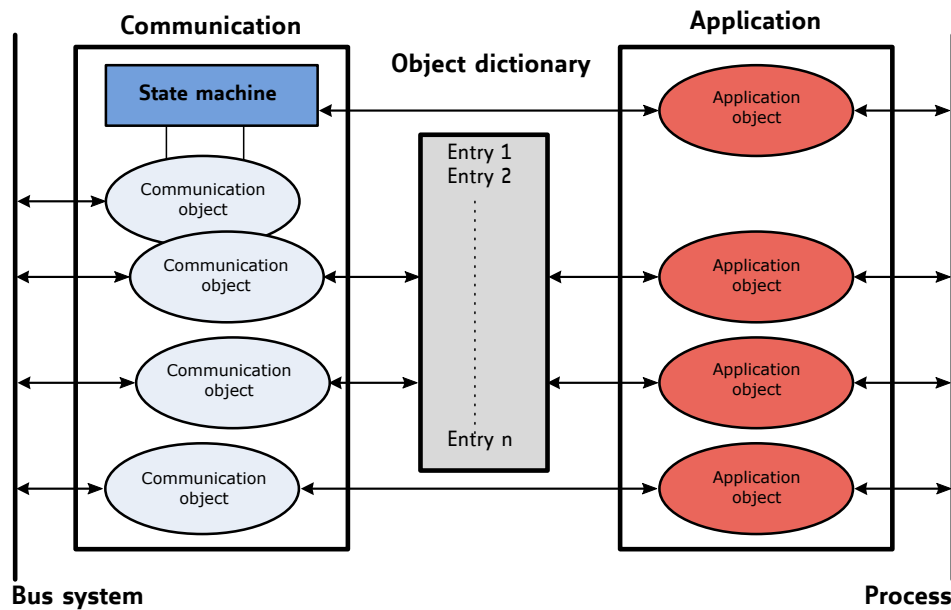

Figure 3: Device Model

2.4 Object Dictionary

The most important part of a device profile is the object dictionary description. The object dictionary is essentially a grouping of objects accessible via the network in an ordered pre-defined fashion. Each object within the dictionary is addressed using a 16-bit index. The overall layout of the standard object dictionary is shown in table 4:

Object Dictionary	
Index	Object
0000 _h	Not used.
0001 _h – 001F _h	Static data types.
0020 _h – 003F _h	Complex data types.
0040 _h – 005F _h	Manufacturer specific complex data types.
0060 _h – 007F _h	Device profile specific static data types.
0080 _h – 009F _h	Device profile specific complex data types.
00A0 _h – 0FFF _h	Reserved for further use.
1000 _h – 1FFF _h	Communication profile area.
2000 _h – 5FFF _h	Manufacturer specific profile area.
6000 _h – 9FFF _h	Standardized device profile area.
A000 _h – BFFF _h	Standardized interface profile area.
C000 _h – FFFF _h	Reserved for further use.

Table 4: Object Dictionary



The communication profile area at indices 1000_h through 1FFF_h contains the communication specific parameters for the CAN network. These entries are common to all devices.

The manufacturer segment at indices 2000_h through 5FFF_h contains manufacturer specific objects. These objects control the special features of the Trinamic TMCC160 motion control device.

The standardized device profile area at indices 6000_h through 9FFF_h contains all data objects common to a class of devices that can be read or written via the network. They describe the device parameters and the device functionality of the device profile.

3 Communication area

The communication area contains all objects that define the communication parameters of the CANopen device according to the DS301 standard.

3.1 Detailed object specifications

3.1.1 Object 1000_h: Device Type

This object contains information about the device type. The object 1000_h describes the type of device and its functionality. It is composed of a 16-bit field which describes the device profile that is used and a second 16-bit field which provides additional information about optional functionality of the device.

Object Description			
Index	Name	Object Type	Data Type
1000 _h	Device type	Variable	UNSIGNED32

Table 5: Object Description (1000_h)

Entry Description				
Sub-index	Access	PDO Mapping	Value Range	Default Value
0	ro	no	UNSIGNED32	FFFC0192 _h

Table 6: Entry Description (1000_h)

3.1.2 Object 1001_h: Error Register

This object contains information about the device type. The object 1000_h describes the type of device and its functionality. It is composed of a 16-bit field which describes the device profile that is used and a second 16-bit field which provides additional information about optional functionality of the device.

Object Description			
Index	Name	Object Type	Data Type
1001 _h	Error register	Variable	UNSIGNED8

Table 7: Object Description (1001_h)



Entry Description				
Sub-index	Access	PDO Mapping	Value Range	Default Value
0	ro	no	UNSIGNED8	0

Table 8: Entry Description (1001_h)

Error Register Bits	
Bit	Definition
0	Generic error
1	Current
2	Voltage
3	Temperature
4	Communication error
5	Device profile specific
6	Reserved (always 0)
7	Manufacturer specific

Table 9: Error Register Bits

3.1.3 Object 1005_h: COB-ID SYNC Message

This object defines the COB-ID of the synchronization object (SYNC). Further, it defines whether the module generates the SYNC.

Value Definition		
Bit	Name	Definition
30	Generate	0: Device does not generate SYNC message 1: Device generates SYNC message
29	Frame	Not supported, always set to 0.
28... 11	29 bit ID	Not supported, always set to 0.
10... 0	11 bit ID	11 bit COB-ID.

Table 10: Value Definition (1005_h)

Object Description			
Index	Name	Object Type	Data Type
1005 _h	COB-ID SYNC message	Variable	UNSIGNED32

Table 11: Object Description (1005_h)



Entry Description				
Sub-index	Access	PDO Mapping	Value Range	Default Value
0	rw	no	UNSIGNED32	80 _h

Table 12: Entry Description (1005_h)

3.1.4 Object 1008_h: Manufacturer Device Name

This object contains the manufacturer device name.

Object Description			
Index	Name	Object Type	Data Type
1008 _h	Manufacturer Device Name	Variable	Visible String

Table 13: Object Description (1008_h)

Entry Description				
Sub-index	Access	PDO Mapping	Value Range	Default Value
0	ro	no	—	TMCC160

Table 14: Entry Description (1008_h)

3.1.5 Object 1009_h: Manufacturer Hardware Version

This object contains the hardware version description.

Object Description			
Index	Name	Object Type	Data Type
1009 _h	Manufacturer Hardware Version	Variable	Visible String

Table 15: Object Description (1009_h)

Entry Description				
Sub-index	Access	PDO Mapping	Value Range	Default Value
0	ro	no	—	Depends on device, e.g. 1.0.

Table 16: Entry Description (1009_h)

3.1.6 Object 100A_h: Manufacturer Software Version

This object contains the software version description.



Object Description			
Index	Name	Object Type	Data Type
100A _h	Manufacturer Software Version	Variable	Visible String

Table 17: Object Description (100A_h)

Entry Description				
Sub-index	Access	PDO Mapping	Value Range	Default Value
0	ro	no	—	Depends on device, e.g. 1.0.

Table 18: Entry Description (100A_h)

3.1.7 Object 100C_h: Guard Time

The objects at index 100C_h and 100D_h shall indicate the configured guard time respectively the life time factor. The life time factor multiplied with the guard time gives the life time for the life guarding protocol.

Object Description			
Index	Name	Object Type	Data Type
100C _h	Guard Time	Variable	UNSIGNED16

Table 19: Object Description (100C_h)

Entry Description				
Sub-index	Access	PDO Mapping	Value Range	Default Value
0	rw	no	UNSIGNED16	0

Table 20: Entry Description (100C_h)

3.1.8 Object 100D_h: Life Time Factor

The life time factor multiplied with the guard time gives the life time for the life guarding protocol.

Object Description			
Index	Name	Object Type	Data Type
100D _h	Life Time Factor	Variable	UNSIGNED8

Table 21: Object Description (100D_h)

Entry Description				
Sub-index	Access	PDO Mapping	Value Range	Default Value
0	rw	no	UNSIGNED8	0

Table 22: Entry Description (100D_h)

3.1.9 Object 1010_h: Store Parameters

This object supports the saving of parameters in non volatile memory. By read access the device provides information about its saving capabilities.

There are several parameter groups:

- Sub-index 0_h: contains the largest sub-index that is supported.
- Sub-index 1_h: saves all parameters.
- Sub-index 2_h: saves communication parameters 100C_h, 100D_h, 1015_h, 1017_h, and 1029_h.
- Sub-index 3_h: saves device profile parameters.
- Sub-index 4_h: saves motor 0 parameters.

Note

In order to avoid storage of parameters by mistake, storage is only executed when a specific signature is written to the appropriate sub-Index. This signature is "save" (65766173_h, see also table 23).

Save Signature			
e	v	a	s
65 _h	76 _h	61 _h	73 _h

Table 23: Save Signature

On reception of the correct signature in the appropriate sub-index the device stores the parameter and then confirms the SDO transmission (initiate download response). If the storing failed, the device responds with an abort SDO transfer (abort code: 06060000_h). If a wrong signature is written, the device refuses to store and responds with abort SDO transfer (abort code: 0800002x_h).

On read access, each sub-index provides information if it is possible to store the parameter group. It reads 1 if yes and 0 if no.

Object Description			
Index	Name	Object Type	Data Type
1010 _h	Store Parameters	Array	UNSIGNED32

Table 24: Object Description (1010_h)

Entry Description					
Sub-index	Description	Access	PDO Mapping	Value Range	Default Value
01h	Save all parameters	rw	no	UNSIGNED32	—
02h	Save communication parameters	rw	no	UNSIGNED32	—
03h	Save device profile parameters	rw	no	UNSIGNED32	—
04h	Save motor axis 0 parameters	rw	no	UNSIGNED32	—

Table 25: Entry Description (1010_h)

3.1.10 Object 1011_h: Restore Parameters

With this object the default values of parameters according to the communication or device profile are restored. By read access the device provides information about its capabilities to restore these values.

There are several parameter groups:

- Sub-index 0_h: contains the largest sub-index that is supported.
- Sub-index 1_h: restores all parameters.
- Sub-index 2_h: restores communication parameters 100C_h, 100D_h, 1015_h, 1017_h, and 1029_h.
- Sub-index 3_h: restores device profile parameters.
- Sub-index 4_h: restores motor 0 parameters.

Note

In order to avoid restoring the parameters by mistake, restoring is only executed when a specific signature is written to the appropriate sub-Index. This signature is "load" (64616F6C_h, see also table 26).

Load Signature			
d	a	o	l
64 _h	61 _h	6F _h	6C _h

Table 26: Load Signature

On reception of the correct signature in the appropriate sub-index the device restores the parameter and then confirms the SDO transmission (initiate download response). If the restoring failed, the device responds with an abort SDO transfer (abort code: 06060000_h). If a wrong signature is written, the device refuses to restore and responds with abort SDO transfer (abort code: 0800002x_h).

On read access, each sub-index provides information if it is possible to restore the parameter group. It reads 1 if yes and 0 if no.

After the default values have been restored they will become active after the next rest or power cycle of the TMCC160.



Object Description			
Index	Name	Object Type	Data Type
1011 _h	Restore parameters	Array	UNSIGNED32

Table 27: Object Description (1011_h)

Entry Description					
Sub-index	Description	Access	PDO Mapping	Value Range	Default Value
01h	Restore all parameters	rw	no	UNSIGNED32	—
02h	Restore communication parameters	rw	no	UNSIGNED32	—
03h	Restore device profile parameters	rw	no	UNSIGNED32	—
04h	Restore motor axis 0 parameters	rw	no	UNSIGNED32	—

Table 28: Entry Description (1011_h)

3.1.11 Object 1014_h: COB-ID Emergency Object

This object defines the COB-ID of the emergency object (EMCY).

Object Description			
Index	Name	Object Type	Data Type
1014 _h	COB-ID emergency object	Variable	UNSIGNED32

Table 29: Object Description (1014_h)

Entry Description				
Sub-index	Access	PDO Mapping	Value Range	Default Value
0	rw	no	UNSIGNED32	80 _h + Node ID

Table 30: Entry Description (1014_h)

3.1.12 Object 1015_h: Inhibit Time EMCY

The inhibit time for the EMCY message can be adjusted via this entry. The time has to be a multiple of 100 μ s.

Object Description			
Index	Name	Object Type	Data Type
1015 _h	COB-ID emergency object	Variable	UNSIGNED16

Table 31: Object Description (1015_h)



Entry Description				
Sub-index	Access	PDO Mapping	Value Range	Default Value
0	rw	no	UNSIGNED16	0

Table 32: Entry Description (1015_h)

3.1.13 Object 1016_h: Consumer Heartbeat Time

The consumer heartbeat time defines the expected heartbeat cycle time and thus has to be higher than the corresponding producer heartbeat time configured on the module producing this heartbeat. The monitoring starts after the reception of the first heartbeat. If the consumer heartbeat time is 0 the corresponding entry is not used. The time has to be a multiple of 1ms.

Value Definition		
Bits	Name	Definition
31...24	Reserved	—
23...16	Node ID	Heartbeat Producer Node ID
15...0	Heartbeat time	Time in 1ms

Table 33: Value Definition (1016_h)

Object Description			
Index	Name	Object Type	Data Type
1016 _h	Consumer heartbeat time	Variable	UNSIGNED16

Table 34: Object Description (1016_h)

Entry Description				
Sub-index	Access	PDO Mapping	Value Range	Default Value
0	rw	no	UNSIGNED16	0

Table 35: Entry Description (1016_h)

3.1.14 Object 1017_h: Producer Heartbeat Time

The producer heartbeat time defines the cycle time of the heartbeat. The producer heartbeat time is 0 if it is not used. The time has to be a multiple of 1ms.



Object Description			
Index	Name	Object Type	Data Type
1017 _h	Producer heartbeat time	Variable	UNSIGNED16

Table 36: Object Description (1017_h)

Entry Description				
Sub-index	Access	PDO Mapping	Value Range	Default Value
0	rw	no	UNSIGNED16	0

Table 37: Entry Description (1017_h)

3.1.15 Object 1018_h: Identity Object

The object 1018_h contains general information about the device:

- The vendor ID (sub-index 01_h) contains a unique value allocated to each manufacturer. The vendor ID of Trinamic is 286_h.
- The manufacturer specific product code (sub-index 2_h) identifies a specific device version.
- The manufacturer specific revision number (sub-index 3_h) consists of a major revision number and a minor revision number.

Object Description			
Index	Name	Object Type	Data Type
1018 _h	Identity object	Record	Identity

Table 38: Object Description (1018_h)

Entry Description					
Sub-index	Description	Access	PDO Mapping	Value Range	Default Value
00 _h	Number of entries	ro	no	0...3	3
01 _h	Vendor ID	ro	no	UNSIGNED32	0286 _h
02 _h	Product code	ro	no	UNSIGNED32	160
03 _h	Revision number	ro	no	UNSIGNED32	e.g. 20003 _h for version 2.3

Table 39: Entry Description (1018_h)

3.1.16 Object 1029_h: Error Behaviour

If a device failure is detected in operational state, the device can be configured to enter alternatively the stopped state or remain in the current state in case of a device failure. Device failures include the following errors:



- Communication error
- Application error

Object Description			
Index	Name	Object Type	Data Type
1029 _h	Error behaviour	Array	UNSIGNED8

Table 40: Object Description (1029_h)

Entry Description					
Sub-index	Description	Access	PDO Mapping	Value Range	Default Value
00 _h	Number of error classes	ro	no	—	2
01 _h	Communication error	rw	no	UNSIGNED8	0 (enter stopped state)
02 _h	Application error	rw	no	UNSIGNED8	1 (remain in current state)

Table 41: Entry Description (1029_h)

3.1.17 Objects 1400_h – 1403_h: Receive PDO Communication Parameter

This object contains the communication parameters for the RPDOs which the device is able to receive. The sub-index 00_h contains the number of valid entries within the communication record. Its value normally is 2, as this object consists of two other entries.

Sub-index 01_h contains the COB-ID used by this PDO (in bits 10...0). Bit 30 (RTR bit) defines if this PDO uses RTRs. As RTRs are not supported for PDOs by this CANopen implementation, this bit must always be set in order to turn off RTR support for this PDO. Bit 31 defines if this PDO is active or not. If this bit is set, the PDO is inactive, and if this bit is clear, the PDO is active. Before making any changes to a PDO definition, set this bit to inactivate the PDO.

Sub-Index 02_h contains the transmission type of the RPDO. This can be FF_h or FE_h for event-driven, or 00_h for synchronous.

Object Description			
Index	Name	Object Type	Data Type
1400 _h – 1403 _h	Receive PDO parameter	RECORD	RPDO CommPar
1400 _h	RPDO 1	RECORD	RPDO CommPar
1401 _h	RPDO 2	RECORD	RPDO CommPar
1402 _h	RPDO 3	RECORD	RPDO CommPar
1403 _h	RPDO 4	RECORD	RPDO CommPar

Table 42: Object Description (1400_h)



Entry Description				
Sub-index	Description	Access	Value Range	Default Value
00 _h	Largest sub-index supported	ro	2	2
01 _h	COB-ID used by PDO	rw	UNSIGNED32	Index 1400 _h : 200 _h + Node-ID Index 1401 _h : 300 _h + Node-ID Index 1402 _h : 400 _h + Node-ID Index 1403 _h : 500 _h + Node-ID
02 _h	Transmission type	rw	UNSIGNED8	Index 1400 _h : FF _h Index 1401 _h : FF _h Index 1402 _h : FF _h Index 1403 _h : FE _h

Table 43: Entry Description (1400_h)

3.1.18 Objects 1600_h – 1603_h: Receive PDO Mapping Parameter

These objects contain the mapping parameters for the RPDOs the device is able to receive. The sub-index 00_h contains the number of valid entries within the mapping record. This number of entries is also the number of the application variables which shall be received with the corresponding RPDO. The sub-indices from 01_h to the number of entries contain the information about the mapped application variables. These entries describe the PDO contents by their index, sub-index and length.

Object Description			
Index	Name	Object Type	Data Type
1600 _h – 1603 _h	Receive PDO mapping parameter	RECORD	PDO Mapping
1600 _h	RPDO 1	RECORD	PDO Mapping
1601 _h	RPDO 2	RECORD	PDO Mapping
1602 _h	RPDO 3	RECORD	PDO Mapping
1603 _h	RPDO 4	RECORD	PDO Mapping

Table 44: Object Description (1600_h)

Entry Description				
Sub-index	Description	Access	Value Range	Default Value
00 _h	Number of mapped application objects in PDO	rw	0...3	Index 1600 _h : 1 Index 1601 _h : 2 Index 1602 _h : 2 Index 1603 _h : 2
01 _h	Mapping entry 1	rw	UNSIGNED32	Index 1600 _h : 60400010 _h Index 1601 _h : 60400010 _h Index 1602 _h : 60400010 _h Index 1603 _h : 60400010 _h
02 _h	Mapping entry 2	rw	UNSIGNED32	Index 1600 _h : 0 Index 1601 _h : 60600008 _h Index 1602 _h : 607A0020 _h Index 1603 _h : 60FF0020 _h
03 _h	Mapping entry 3	rw	UNSIGNED32	Index 1600 _h : 0 _h Index 1601 _h : 0 _h Index 1602 _h : 0 _h Index 1603 _h : 0 _h

Table 45: Entry Description (1600_h)

Before making changes to PDO definitions, first mark the PDO as inactive by setting bit 31 of its COB-ID (see section 3.1.17). Then, set its number of mapped PDO entries to zero (sub-index 0 of the appropriate PDO mapping object). Now, the mappings themselves can be changed. After that, set the number of map objects to the desired value, and finally activate the PDO by clearing bit 31 of its COB-ID.

3.1.19 Objects 1800_h – 1803_h: Transmit PDO Communication Parameter

This object contains the communication parameters for the TPDOs which the device is able to transmit. The sub-index 00_h contains the number of valid entries within the communication record. Its value normally is 5, as this object consists of five other entries.

Sub-index 01_h contains the COB-ID used by this PDO (in bits 10...0). Bit 30 (RTR bit) defines if this PDO uses RTRs. As RTRs are not supported for PDOs by this CANopen implementation, this bit must always be set in order to turn off RTR support for this PDO. Bit 31 defines if this PDO is active or not. If this bit is set, the PDO is inactive, and if this bit is clear, the PDO is active. Before making any changes to a PDO definition, set this bit to inactivate the PDO.

Sub-index 02_h contains the transmission type of the RPDO. This can be FF_h or FE_h for event-driven, or 00_h or 01_h for synchronous.

Sub-index 03_h contains the inhibit time, given in milliseconds. After a TPDO has been sent, it will not be sent again before the inhibit time has elapsed.

Sub-index 04_h is not used.

Sub-index 05_h contains the event timer value in milliseconds. When this is set to a value greater than 0 the TPDO will be sent repeatedly each time the event timer has elapsed. For example, when this value is set to 250, the TPDO will be sent every 250ms.



Object Description			
Index	Name	Object Type	Data Type
1800 _h – 1803 _h	Transmit PDO communication parameter	RECORD	TPDO CommPar
1800 _h	TPDO 1	RECORD	TPDO CommPar
1801 _h	TPDO 2	RECORD	TPDO CommPar
1802 _h	TPDO 3	RECORD	TPDO CommPar
1803 _h	TPDO 4	RECORD	TPDO CommPar

Table 46: Object Description (1800_h)

Entry Description				
Sub-index	Description	Access	Value Range	Default Value
00 _h	Largest sub-index supported	ro	5	5
01 _h	COB-ID	rw	UNSIGNED32	Index 1800 _h : 180 _h + Node-ID Index 1801 _h : 280 _h + Node-ID Index 1802 _h : 380 _h + Node-ID Index 1803 _h : 480 _h + Node-ID
02 _h	Transmission type	rw	UNSIGNED8	Index 1800 _h : FF _h Index 1801 _h : FF _h Index 1802 _h : 01 _h Index 1803 _h : 01 _h
03 _h	Inhibit time	rw	UNSIGNED16	0
04 _h	Compatibility entry	ro	UNSIGNED8	0
05 _h	Event timer	rw	UNSIGNED16	0

Table 47: Entry Description (1800_h)

3.1.20 Objects 1A00_h – 1A03_h: Transmit PDO Mapping Parameter

These objects contain the mapping parameters for the TPDOs the device is able to transmit. The sub-index 00_h contains the number of valid entries within the mapping record. This number of entries is also the number of the application variables which shall be transmitted with the corresponding TPDO. The sub-indices from 01_h to the number of entries contain the information about the mapped application variables. These entries describe the PDO contents by their index, sub-index and length.



Object Description			
Index	Name	Object Type	Data Type
1A00 _h – 1A03 _h	Transmit PDO mapping parameter	RECORD	PDO Mapping
1A00 _h	TPDO 1	RECORD	PDO Mapping
1A01 _h	TPDO 2	RECORD	PDO Mapping
1A02 _h	TPDO 3	RECORD	PDO Mapping
1A03 _h	TPDO 4	RECORD	PDO Mapping

Table 48: Object Description (1A00_h)

Entry Description				
Sub-index	Description	Access	Value Range	Default Value
00 _h	Number of mapped application objects in PDO	rw	0...3	Index 1A00 _h : 1 Index 1A01 _h : 2 Index 1A02 _h : 2 Index 1A03 _h : 2
01 _h	Mapping entry 1	rw	UNSIGNED32	Index 1A00 _h : 60410010 _h Index 1A01 _h : 60410010 _h Index 1A02 _h : 60410010 _h Index 1A03 _h : 60410010 _h
02 _h	Mapping entry 2	rw	UNSIGNED32	Index 1A00 _h : 0 Index 1A01 _h : 60610008 _h Index 1A02 _h : 60640020 _h Index 1A03 _h : 606C0020 _h
03 _h	Mapping entry 3	rw	UNSIGNED32	Index 1A00 _h : 0 _h Index 1A01 _h : 0 _h Index 1A02 _h : 0 _h Index 1A03 _h : 0 _h

Table 49: Entry Description (1A00_h)

Before making changes to PDO definitions, first mark the PDO as inactive by setting bit 31 of its COB-ID (see section 3.1.19). Then, set its number of mapped PDO entries to zero (sub-index 0 of the appropriate PDO mapping object). Now, the mappings themselves can be changed. After that, set the number of mapped objects to the desired value, and finally activate the PDO by clearing bit 31 of its COB-ID.

4 Manufacturer specific area

The manufacturer segment contains manufacturer specific objects. These objects control the special features of the Trinamic Motion Control device TMCC160.

4.1 Detailed object specifications

4.1.1 Object 200D_h: Status Flags

This object provides information about the actual module status flags. (0: not active, 1: active).



This object is organized bit-wise. The bits have the following meaning:

- Bit 0: OVERCURRENT
- Bit 1: UNDERVOLTAGE
- Bit 2: OVERVOLTAGE
- Bit 3: OVERTEMPERATURE
- Bit 4: MOTORHALTED
- Bit 5: HALLERROR
- Bit 6: DRIVER_ERROR
- Bit 7: INIT_ERROR
- Bit 8: STOP_MODE
- Bit 9: VELOCITY_MODE
- Bit 10: POSITION_MODE
- Bit 11: TORQUE_MODE
- Bit 12: EMERGENCYSTOP
- Bit 13: FREERUNNING
- Bit 14: POSITION_END
- Bit 15: MODULE_INITIALIZED
- Bit 16: unused
- Bit 17: IIT_EXCEEDED

Object Description			
Index	Name	Object Type	Data Type
200D _h	Status Flags	Variable	UNSIGNED32

Table 50: Object Description (200D_h)

Entry Description							
Sub-index	Name	PDO Mapping	Min	Max	Default	Unit	Access
0	Status Flags	no	0	4294967295	0		R

Table 51: Entry Description (200D_h)

4.1.2 Object 200E_h: Supply Voltage

The actual supply voltage.

Object Description			
Index	Name	Object Type	Data Type
200E _h	Supply Voltage	Variable	UNSIGNED32

Table 52: Object Description (200E_h)



Entry Description							
Sub-index	Name	PDO Mapping	Min	Max	Default	Unit	Access
0	Supply Voltage	no	0	1000	300	[100mV]	R

Table 53: Entry Description (200E_h)

4.1.3 Object 200F_h: Driver Temperatur

The actual temperature of the motor driver.

Object Description			
Index	Name	Object Type	Data Type
200F _h	Driver Temperatur	Variable	SIGNED32

Table 54: Object Description (200F_h)

Entry Description							
Sub-index	Name	PDO Mapping	Min	Max	Default	Unit	Access
0	Driver Temperature	no	-20	150	0	[degree]	R

Table 55: Entry Description (200F_h)

4.1.4 Object 2010_h: Motor Settings

Object Description			
Index	Name	Object Type	Data Type
2010 _h	Motor Settings	Variable	Record

Table 56: Object Description (2010_h)

Entry Description							
Sub-index	Name	PDO Mapping	Min	Max	Default	Unit	Access
1	MotorPoles	no	2	254	8		RW

Table 57: Entry Description (2010_h)



4.1.5 Object 2020_h: Limits

Object Description			
Index	Name	Object Type	Data Type
2020 _h	Limits	Variable	Record

Table 58: Object Description (2020_h)

Entry Description							
Sub-index	Name	PDO Mapping	Min	Max	Default	Unit	Access
1	MaxTorque	no	0	90000	4000	[mA] (peak)	RW
2	MaxVelocity	no	0	200000	4000	[rpm]	RW
3	MaxAcceleration	no	0	100000	2000	[rpm/s]	RW

Table 59: Entry Description (2020_h)

4.1.6 Object 2030_h: Torque Mode Settings

Object Description			
Index	Name	Object Type	Data Type
2030 _h	Torque Mode Settings	Variable	Record

Table 60: Object Description (2030_h)

Entry Description							
Sub-index	Name	PDO Mapping	Min	Max	Default	Unit	Access
1	ActualCurrent	no	-2147483648	2147483647	0	[mA] (peak)	R
2	TargetCurrent	no	-90000	90000	0	[mA] (peak)	R
3	RampTargetCurrent	no	-90000	90000	0	[mA] (peak)	R
4	P_Parameter	no	0	65535	0		RW
5	I_Parameter	no	0	65535	0		RW
6	PI_Torque_Error	no	-2147483648	2147483647	0	[mA]	R
7	PI_Torque_Error_Sum	no	-2147483648	2147483647	0		R
8	PI_Flux_Error	no	-2147483648	2147483647	0	[mA]	R
9	PI_Flux_Error_Sum	no	-2147483648	2147483647	0		R

Table 61: Entry Description (2030_h)



4.1.7 Object 2040_h: Velocity Mode Settings

Object Description			
Index	Name	Object Type	Data Type
2040 _h	Velocity Mode Settings	Variable	Record

Table 62: Object Description (2040_h)

Entry Description							
Sub-index	Name	PDO Mapping	Min	Max	Default	Unit	Access
1	ActualVelocity	no	-2147483648	2147483647	0	[rpm]	R
2	TargetVelocity	no	-200000	200000	0	[rpm]	R
3	RampTargetVelocity	no	-2147483648	2147483647	0	[rpm]	R
4	MotorHaltedVelocity	no	0	200000	5	[rpm]	RW
5	P_Parameter	no	0	65535	0		RW
6	I_Parameter	no	0	65535	0		RW
7	PI_Velocity_Error	no	-2147483648	2147483647	0	[rpm]	R
8	PI_Velocity_Error_Sum	no	-2147483648	2147483647	0		R

Table 63: Entry Description (2040_h)

4.1.8 Object 2050_h: Position Mode Settings

Object Description			
Index	Name	Object Type	Data Type
2050 _h	Position Mode Settings	Variable	Record

Table 64: Object Description (2050_h)



Entry Description							
Sub-index	Name	PDO Mapping	Min	Max	Default	Unit	Access
1	ActualPosition	no	-2147483648	2147483647	0		RW
2	TargetPosition	no	-2147483648	2147483647	0		R
3	RampTargetPosition	no	-2147483648	2147483647	0		R
4	P_Parameter	no	0	65535	0		RW
5	PI_Position_Error	no	-2147483648	2147483647	0		R
6	TargetReachedVelocity	no	0	200000	500	[rpm]	RW
7	TargetReachedDistance	no	0	100000	5		RW

Table 65: Entry Description (2050_h)

4.1.9 Object 2055_h: Commutation Mode

Select a commutation mode that fits best to your motor’s sensors.

- 6 : FOC (hall sensor)
- 7 : FOC (encoder)
- 8 : FOC (controlled)

Object Description			
Index	Name	Object Type	Data Type
2055 _h	Commutation Mode	Variable	Record

Table 66: Object Description (2055_h)

Entry Description							
Sub-index	Name	PDO Mapping	Min	Max	Default	Unit	Access
0	Commutation Mode	no	6	8	6		RW

Table 67: Entry Description (2055_h)

4.1.10 Object 2056_h: Velocity Ramp Mode

An activated ramp allows a defined acceleration for velocity and position mode.

Object Description			
Index	Name	Object Type	Data Type
2056 _h	Velocity Ramp Mode	Variable	UNSIGNED8

Table 68: Object Description (2056_h)



Entry Description							
Sub-index	Name	PDO Mapping	Min	Max	Default	Unit	Access
0	Velocity Ramp Mode	no	0	1	1		RW

Table 69: Entry Description (2056_h)

4.1.11 Object 2060_h: Open Loop Settings

Object Description			
Index	Name	Object Type	Data Type
2060 _h	Open Loop Settings	Variable	Record

Table 70: Object Description (2060_h)

Entry Description							
Sub-index	Name	PDO Mapping	Min	Max	Default	Unit	Access
1	ActualAngle	no	-32768	32767	0		R
2	OpenLoopCurrent	no	0	90000	1500	[mA] (peak)	RW

Table 71: Entry Description (2060_h)

4.1.12 Object 2070_h: Hall Sensor Settings

Object Description			
Index	Name	Object Type	Data Type
2070 _h	Hall Sensor Settings	Variable	Record

Table 72: Object Description (2070_h)

Entry Description							
Sub-index	Name	PDO Mapping	Min	Max	Default	Unit	Access
1	ActualAngle	no	-32768	32767	0		R
2	Inversion	no	0	1	0		RW
3	Interpolation	no	0	1	0		RW

Table 73: Entry Description (2070_h)



4.1.13 Object 2080_h: ABN Encoder Settings

Object Description			
Index	Name	Object Type	Data Type
2080 _h	ABN Encoder Settings	Variable	Record

Table 74: Object Description (2080_h)

Entry Description							
Sub-index	Name	PDO Mapping	Min	Max	Default	Unit	Access
1	ActualAngle	no	-32768	32767	0		R
2	StepsPerRotation	no	0	65535	4000		RW
3	Offset	no	0	65535	0		RW
4	Direction	no	0	1	0		RW
5	InitMode	no	0	2	1		RW
6	InitDelay	no	0	10000	1000	[ms]	RW
7	InitVelocity	no	-200000	200000	100	[rpm]	RW

Table 75: Entry Description (2080_h)

4.1.14 Object 2090_h: Brake Chopper Settings

Object Description			
Index	Name	Object Type	Data Type
2090 _h	Brake Chopper Settings	Variable	Record

Table 76: Object Description (2090_h)

Entry Description							
Sub-index	Name	PDO Mapping	Min	Max	Default	Unit	Access
1	EnableBrakeChopper	no	0	1	0		RW
2	BrakeChopperVoltageLimit	no	50	480	260	[100mV]	RW
3	BrakeChopperHysteresis	no	0	50	5	[100mV]	RW

Table 77: Entry Description (2090_h)



4.1.15 Object 2095_h: IIT Settings

Object Description			
Index	Name	Object Type	Data Type
2095 _h	IIT Settings	Variable	Record

Table 78: Object Description (2095_h)

Entry Description							
Sub-index	Name	PDO Mapping	Min	Max	Default	Unit	Access
1	ThermalWindingTimeConstant	no	0	300000	30000	[ms]	RW
2	IitLimit	no	0	270000000	5880000		RW
3	IitSum	no	0	4294967295	0		R
4	IitExceededCounter	no	0	4294967295	0		RW
5	ClearIitExceededFlag	no	0	0	0		W

Table 79: Entry Description (2095_h)

4.1.16 Object 2100_h: Home Offset Display

This object shows the home offset. The value is given in encoder or hall increments.

Object Description			
Index	Name	Object Type	Data Type
2100 _h	Home Offset Display	Variable	SIGNED32

Table 80: Object Description (2100_h)

Entry Description							
Sub-index	Name	PDO Mapping	Min	Max	Default	Unit	Access
0	Home Offset Display	no	-2147483648	2147483647	0		R

Table 81: Entry Description (2100_h)

4.1.17 Object 2702_h: Digital Inputs

Bit0: Left limit switch status

Bit1: Right limit switch status



Object Description			
Index	Name	Object Type	Data Type
2702 _h	Digital Inputs	Variable	UNSIGNED32

Table 82: Object Description (2702_h)

Entry Description							
Sub-index	Name	PDO Mapping	Min	Max	Default	Unit	Access
0	Digital Inputs	no	0	7	0		R

Table 83: Entry Description (2702_h)

4.1.18 Object 2704_h: CAN Bit Rate

With this object it is possible to change the CAN bit rate.

To do this, first write the new value to this object. Then, store the new setting by writing the save signature to object 2706h. After that, reset the module. The new setting then becomes active.

(Available bit rates: 20, 50, 100, 125, 250, 500, 800, 1000)

Object Description			
Index	Name	Object Type	Data Type
2704 _h	CAN Bit Rate	Variable	UNSIGNED16

Table 84: Object Description (2704_h)

Entry Description							
Sub-index	Name	PDO Mapping	Min	Max	Default	Unit	Access
0	CAN Bit Rate	no	20	1000	1000		RW

Table 85: Entry Description (2704_h)

4.1.19 Object 2705_h: Node ID

On modules that do not have address switches the node ID can be selected using this object.

On modules with address switches the node ID is normally selected using the address switches.

To change the node ID, first write the new node ID to this object. Then, store the new setting by writing the save signature to object 2706h. After that, reset the module. The new setting then becomes active.



Object Description			
Index	Name	Object Type	Data Type
2705 _h	Node ID	Variable	UNSIGNED8

Table 86: Object Description (2705_h)

Entry Description							
Sub-index	Name	PDO Mapping	Min	Max	Default	Unit	Access
0	Node ID	no	1	127	1		RW

Table 87: Entry Description (2705_h)

4.1.20 Object 2706_h: Store

Writing the save signature to this object permanently saves changes made to objects 2704h and 2705h. The save signature is 65766173h.

Object Description			
Index	Name	Object Type	Data Type
2706 _h	Store	Variable	UNSIGNED32

Table 88: Object Description (2706_h)

Entry Description							
Sub-index	Name	PDO Mapping	Min	Max	Default	Unit	Access
0	Store	no	0	4294967295	0		RW

Table 89: Entry Description (2706_h)

4.1.21 Object 2707_h: CAN Bit Rate Load

This object shows the selected CAN bit rate.

Object Description			
Index	Name	Object Type	Data Type
2707 _h	CAN Bit Rate Load	Variable	UNSIGNED8

Table 90: Object Description (2707_h)



Entry Description							
Sub-index	Name	PDO Mapping	Min	Max	Default	Unit	Access
0	CAN Bit Rate Load	no	20	1000	1000		R

Table 91: Entry Description (2707_h)

4.1.22 Object 2708_h: Node ID Load

This object shows the selected node ID.

Object Description			
Index	Name	Object Type	Data Type
2708 _h	Node ID Load	Variable	UNSIGNED8

Table 92: Object Description (2708_h)

Entry Description							
Sub-index	Name	PDO Mapping	Min	Max	Default	Unit	Access
0	Node ID Load	no	1	127	1		R

Table 93: Entry Description (2708_h)

4.1.23 Object 270E_h: Analog Inputs

Object Description			
Index	Name	Object Type	Data Type
270E _h	Analog Inputs	Variable	Record

Table 94: Object Description (270E_h)



Entry Description							
Sub-index	Name	PDO Mapping	Min	Max	Default	Unit	Access
1	ADC_IN_0	no	0	4095	0		R
2	ADC_IN_1	no	0	4095	0		R
3	ADC_phase_A	no	0	4095	0		R
4	ADC_phase_B	no	0	4095	0		R
5	ADC_phase_C	no	0	4095	0		R
6	ADC_VSupply	no	0	4095	0		R
7	ADC_Temp	no	0	4095	0		R

Table 95: Entry Description (270E_n)

5 Profile specific area

The profile segment contains CiA-402 standard motion control objects. These objects control the motion control functions of the TMCC160. Since it is not possible to operate the modes in parallel, the user is able to activate the required function by selecting a mode of operation. The control device writes to the modes of operation object in order to select the operation mode. The drive device provides the modes of operation display object to indicate the actual activated operation mode. Controlword, statusword, and set-points are used mode-specific. This implies the responsibility of the control device to avoid inconsistencies and erroneous behavior.

The following operating modes (selectable via object 6060_n, please see 5.1.6) are implemented on the TMCC160:

- Profile position mode (pp)
- Profile velocity mode (pv)
- Cyclic torque mode (cst)
- Homing mode (hm)

5.1 Detailed object specifications

5.1.1 Object 605A_n: Quick Stop Option Code

This object indicates what action is performed when the quick stop function is executed. The slow down ramp is the deceleration value of the used mode of operation. The following quick stop option codes are supported in the current version of the CANopen firmware:

- 1: Slow down on slow down ramp and transit into switch on disabled
- 2: Slow down on quick stop ramp and transit into switch on disabled
- 5: Slow down on slow down ramp and stay in quick stop active)
- 6: Slow down on quick stop ramp and stay in quick stop active



Object Description			
Index	Name	Object Type	Data Type
605A _h	Quick Stop Option Code	Variable	SIGNED16

Table 96: Object Description (605A_h)

Entry Description							
Sub-index	Name	PDO Mapping	Min	Max	Default	Unit	Access
0	Quick Stop Option Code	no	1	6	0		RW

Table 97: Entry Description (605A_h)

5.1.2 Object 605B_h: Shutdown Option Code

This object indicates what action is performed if there is a transition from operation enabled state to ready to switch on state. The shutdown option code always has the value 0 as only this is supported.

0: Disable drive function (switch off the power stage)

Object Description			
Index	Name	Object Type	Data Type
605B _h	Shutdown Option Code	Variable	SIGNED16

Table 98: Object Description (605B_h)

Entry Description							
Sub-index	Name	PDO Mapping	Min	Max	Default	Unit	Access
0	Shutdown Option Code	no	0	0	0		RW

Table 99: Entry Description (605B_h)

5.1.3 Object 605C_h: Disable Operation Option Code

This object indicates what action is performed if there is a transition from operation enabled state to switched on state. The disable operation option code always has the value 1 as only this is supported. The slow down ramp is the deceleration value of the used mode of operation.

1: Slow down on slow down ramp



Object Description			
Index	Name	Object Type	Data Type
605C _h	Disable Operation Option Code	Variable	SIGNED16

Table 100: Object Description (605C_h)

Entry Description							
Sub-index	Name	PDO Mapping	Min	Max	Default	Unit	Access
0	Disable Operation Option Code	no	1	1	1		RW

Table 101: Entry Description (605C_h)

5.1.4 Object 605D_h: Halt Option Code

This object indicates what action is performed when the halt function is executed. The slow down ramp is the deceleration value of the used mode of operation. The halt option code always has the value 1 as only this is supported.

1: Slow down on slow down ramp and stay in operation enabled

Object Description			
Index	Name	Object Type	Data Type
605D _h	Halt Option Code	Variable	SIGNED16

Table 102: Object Description (605D_h)

Entry Description							
Sub-index	Name	PDO Mapping	Min	Max	Default	Unit	Access
0	Halt Option Code	no	1	1	1		RW

Table 103: Entry Description (605D_h)

5.1.5 Object 605E_h: Fault Reaction Option Code

This object indicates what action is performed when fault is detected in the power drive system. The slow down ramp is the deceleration value of the used mode of operation. The fault reaction option code always has the value 2 as only this is supported.

2: Slow down on quick stop ramp



Object Description			
Index	Name	Object Type	Data Type
605E _h	Fault Reaction Option Code	Variable	SIGNED16

Table 104: Object Description (605E_h)

Entry Description							
Sub-index	Name	PDO Mapping	Min	Max	Default	Unit	Access
0	Fault Reaction Option Code	no	2	2	2		RW

Table 105: Entry Description (605E_h)

5.1.6 Object 6060_h: Modes of Operation

This object indicates the requested operation mode. Supported operating modes are:

- 0: No mode
- 1: Profile position mode (pp)
- 3: Profile velocity mode (pv)
- 6: Homing mode (hm)
- 10: Cyclic torque mode (cst)

The motor will not run when the operating mode is set to 0. It will be stopped when the motor is running in one of the supported operating modes and the operating mode is then switched to 0.

Object Description			
Index	Name	Object Type	Data Type
6060 _h	Modes of Operation	Variable	SIGNED8

Table 106: Object Description (6060_h)

Entry Description							
Sub-index	Name	PDO Mapping	Min	Max	Default	Unit	Access
0	Modes of Operation	no	0	10	0		RW

Table 107: Entry Description (6060_h)

5.1.7 Object 6061_h: Modes of Operation Display

This object shows the operating mode that is currently set.

- 0: No mode



- 1: Profile position mode (pp)
- 3: Profile velocity mode (pv)
- 6: Homing mode (hm)
- 10: Cyclic torque mode (cst)

Object Description			
Index	Name	Object Type	Data Type
6061 _h	Modes of Operation Display	Variable	SIGNED8

Table 108: Object Description (6061_h)

Entry Description							
Sub-index	Name	PDO Mapping	Min	Max	Default	Unit	Access
0	Modes of Operation Display	no	0	10	0		R

Table 109: Entry Description (6061_h)

5.1.8 Object 608F_h: Position Encoder Resolution

This object defines the resolution of the encoder. The position encoder resolution is calculated by the following formula: position encoder resolution = encoder increments / motor revolutions.

Object Description			
Index	Name	Object Type	Data Type
608F _h	Position Encoder Resolution	Array	UNSIGNED32

Table 110: Object Description (608F_h)

Entry Description							
Sub-index	Name	PDO Mapping	Min	Max	Default	Unit	Access
1	Encoder increments	no	0	65535	4000		RW
2	Motor revolutions	no	1	1	1		R

Table 111: Entry Description (608F_h)

5.1.9 Object 6099_h: Homing Speeds

This object indicates the configured speeds used during fast and slow homing procedure. In most homing modes, the home switch is searched with the fast speed first. When the home switch has been found, the motor will be decelerated to the slow speed (using the homing acceleration, object 609Ah) to search for the exact switch point. When the switch point has been found the motor will be stopped at that point.



Object Description			
Index	Name	Object Type	Data Type
6099 _h	Homing Speeds	Array	UNSIGNED32

Table 112: Object Description (6099_h)

Entry Description							
Sub-index	Name	PDO Mapping	Min	Max	Default	Unit	Access
1	Fast Homing Speed	no	0	4294967295	0		RW
2	Slow Homing Speed	no	0	4294967295	0		RW

Table 113: Entry Description (6099_h)

5.1.10 Object 60FD_h: Digital Inputs

This object contains the states of the digital inputs of the module. Starting from bit 0, every bit reflects the state of one digital input. The number of valid bits depends on the number of digital inputs of the module.

Object Description			
Index	Name	Object Type	Data Type
60FD _h	Digital Inputs	Variable	UNSIGNED32

Table 114: Object Description (60FD_h)

Entry Description							
Sub-index	Name	PDO Mapping	Min	Max	Default	Unit	Access
0	Limit Switches	no	0	3	0		R

Table 115: Entry Description (60FD_h)

5.1.11 Object 6502_h: Supported Drive Modes

This object provides information on the supported drive modes (0: not supported, 1: supported). This object is organized bit-wise. The bits have the following meaning:

- Bit 0: profile position mode
- Bit 1: velocity mode
- Bit 2: profile velocity mode
- Bit 3: profile torque mode
- Bit 4: reserved
- Bit 5: homing mode
- Bit 6: interpolated position mode



Bit 7: cyclic synchronous position mode
 Bit 8: cyclic synchronous velocity mode
 Bit 9: cyclic synchronous torque mode
 Bit 10-15: reserved
 Bit 16-31: manufacturer-specific

Object Description			
Index	Name	Object Type	Data Type
6502 _h	Supported Drive Modes	Variable	UNSIGNED32

Table 116: Object Description (6502_h)

Entry Description							
Sub-index	Name	PDO Mapping	Min	Max	Default	Unit	Access
0	Supported Drive Modes	no	0	4294967295	0		R

Table 117: Entry Description (6502_h)

6 Profile Position Mode

A target position is applied to the trajectory generator. It is generating a position demand value for the position control loop described in the position control function.

Please refer to object 6060_h (section 5.1.6) for information about how to choose an operation mode. Object 6061_h (section 5.1.7) shows the operation mode that is set.

6.1 Detailed Object Specifications

The following text offers detailed object specifications. For a better understanding, it is necessary to see how the state machine works.



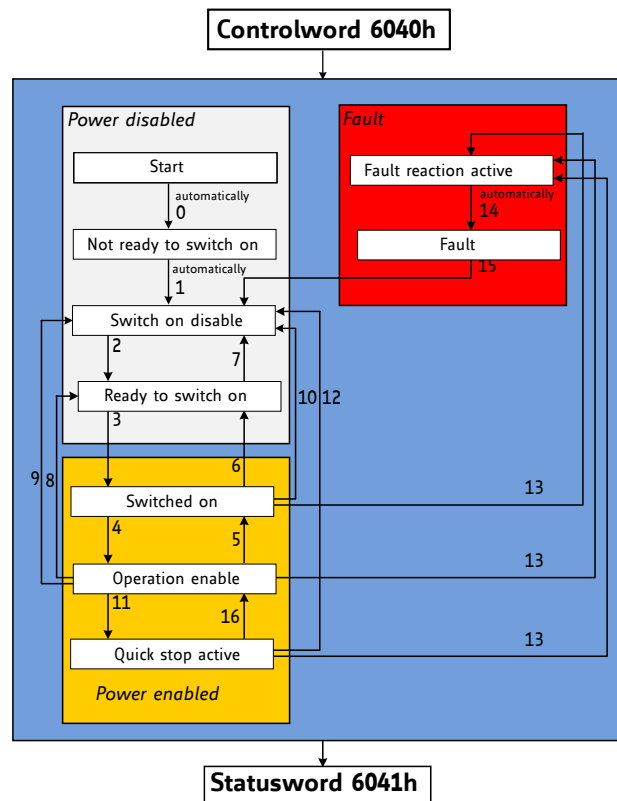

Figure 4: DS402 Finite State Machine

Notes on state transitions:

- Commands directing a change in state are processed completely and the new state achieved before additional state change commands are processed.
- Transitions 0 and 1 occur automatically at drive power-on or reset. Transition 14 occurs automatically, too. All other state changes must be directed by the host.
- Drive function disabled indicates that no current is being supplied to the motor.
- Drive function enabled indicates that current is available for the motor and profile position and profile velocity reference values may be processed.

6.2 Detailed Object Specifications

6.2.1 Object 6040_n: Control Word

This object indicates the received command controlling the power drive system finite state automaton (PDS FSA). The CiA-402 state machine can be controlled using this object. Please refer to figure 4 for detailed information.



Structure of the Control Word											
15	11	10	9	8	7	6	4	3	2	1	0
nu		r	oms	h	fr	oms	eo	qs	ev	so	
MSB						LSB					

Legend: nu=not used; r=reserved; oms=operation mode specific; h=halt; fr=fault reset; eo=enable operation; qs=quick stop; ev=enable voltage; so=switch on.

Table 118: Structure of the Control Word in pp Mode

Operation Mode specific Bits in pp Mode		
Bit	Name	Definition
4	New set point	0-to-1: the next positioning will be started.
5	Change immediately	Not supported.
6	Absolute / relative	0: New position is absolute. 1: New position is relative.
9	Change set point	Not supported.

Table 119: Operation Mode specific Bits in pp Mode

Command Coding						
Command	Bits of Control Word					Transitions
	Bit 7	Bit 3	Bit 2	Bit 1	Bit 0	
Shutdown	0	x	1	1	0	2,6,8
Switch on	0	0	1	1	1	3
Switch on & enable operation	0	1	1	1	1	3, 4
Disable voltage	0	x	x	0	x	7,9,10,12
Quick stop	0	x	0	1	x	7,10,11
Disable operation	0	0	1	1	1	5
Enable operation	0	1	1	1	1	4, 16
Fault reset	0-to-1	x	x	x	x	15

Table 120: Command Coding

Object Description			
Index	Name	Object Type	Data Type
6040 _h	Controlword	Variable	UNSIGNED16

Table 121: Object Description (6040_h in pp Mode)



Entry Description				
Sub-index	Access	PDO Mapping	Value Range	Default Value
0	rw	see CiA402-3	See command coding above.	

Table 122: Entry Description (6040_h in pp Mode)

6.2.2 Object 6041_h: Status Word

This object provides the status of the PDS FSA. It reflects the status of the CiA-402 state machine. Please refer to figure 4 for detailed information. The object is structured as defined below. For more information about the coding please refer to the CANopen Drives and motion control device profile, part 2.

Structure of the Status Word															
15	14	13	12	11	10	9	8	7	6	5	4	3	2	1	0
dir	mot	oms	ila	tr	rm	ms	w	sod	qs	ve	f	oe	so	rtso	
MSB														LSB	

Legend: nu=not used; r=reserved; oms=operation mode specific; h=halt; fr=fault reset; oe=operation enable; qs=quick stop; ve=voltage enable; so=switch on.

Table 123: Structure of the Status Word in pp Mode

Trinamic Specific Bits		
Bit	Name	Definition
14	Motor activity	0: Motor stands still. 1: Motor rotates.
15	Direction of rotation	This bit shows the direction of rotation.

Table 124: Trinamic Specific Bits

Operation Mode specific Bits in pp Mode		
Bit	Name	Definition
10	Target reached	Set when the motor is within the position window.
12	Set point acknowledged	0: Set point processed. 1: Set point still in process.
13	Following error	Not supported.

Table 125: Operation Mode specific Bits in pp Mode



State Coding	
Status word	FSA state
xxxx xxxx x0xx 0000 _h	Not ready to switch on
xxxx xxxx x1xx 0000 _h	Switch on disabled
xxxx xxxx x01x 0001 _h	Ready to switch on
xxxx xxxx x01x 0011 _h	Switched on
xxxx xxxx x01x 0111 _h	Operation enabled
xxxx xxxx x00x 0111 _h	Quick stop active
xxxx xxxx x0xx 1111 _h	Fault reaction active
xxxx xxxx x0xx 1000 _h	Fault

Table 126: State Coding

Object Description			
Index	Name	Object Type	Data Type
6041 _h	Controlword	Variable	UNSIGNED16

Table 127: Object Description (6041_h in pp Mode)

Entry Description				
Sub-index	Access	PDO Mapping	Value Range	Default Value
0	rw	see CiA402-3	See state coding above.	

Table 128: Entry Description (6041_h in pp Mode)

6.2.3 Object 6062_h: Position Demand Value

This object provides the demanded position value. The value is given in hall or encoder steps. Object 6062h indicates the actual position that the motor should have. It is not to be confused with objects 6063h and 6064h.

Object Description			
Index	Name	Object Type	Data Type
6062 _h	Position Demand Value	Variable	SIGNED32

Table 129: Object Description (6062_h)



Entry Description							
Sub-index	Name	PDO Mapping	Min	Max	Default	Unit	Access
0	Position Demand Value	no	-2147483648	2147483647	0		R

Table 130: Entry Description (6062_h)

6.2.4 Object 6063_h: Position Actual Internal Value

This object provides the actual position value of the motor.

Object Description			
Index	Name	Object Type	Data Type
6063 _h	Position Actual Internal Value	Variable	SIGNED32

Table 131: Object Description (6063_h)

Entry Description							
Sub-index	Name	PDO Mapping	Min	Max	Default	Unit	Access
0	Position Actual Internal Value	no	-2147483648	2147483647	0		R

Table 132: Entry Description (6063_h)

6.2.5 Object 6064_h: Position Actual Value

This object provides the actual value of the position measurement device. It always contains the same value as object 6063h.

Object Description			
Index	Name	Object Type	Data Type
6064 _h	Position Actual Value	Variable	SIGNED32

Table 133: Object Description (6064_h)

Entry Description							
Sub-index	Name	PDO Mapping	Min	Max	Default	Unit	Access
0	Position Actual Value	no	-2147483648	2147483647	0		R

Table 134: Entry Description (6064_h)



6.2.6 Object 6067_h: Position Window

This object indicates the configured symmetrical range of accepted positions relative to the target position. If the actual value of the position encoder is within the position window, this target position is regarded as having been reached. The value is given in increments. If the value of the position window is FFFFFFFF_h, the position window control is switched off. If this object is set to zero, the target reached event will be signaled when the demand position (6062_h) has reached the target position (6064_h). When the position window is set to a value greater than zero, the target reached event will be signaled when the actual encoder position value (6064_h) is within (target_position - position_window) and (target_position + position_window).

Object Description			
Index	Name	Object Type	Data Type
6067 _h	Position Window	Variable	UNSIGNED32

Table 135: Object Description (6067_h)

Entry Description							
Sub-index	Name	PDO Mapping	Min	Max	Default	Unit	Access
0	Position Window	no	0	4294967295	4294967295		RW

Table 136: Entry Description (6067_h)

6.2.7 Object 606C_h: Velocity Actual Value

This object shows the actual velocity value derived from the velocity sensor.

Object Description			
Index	Name	Object Type	Data Type
606C _h	Velocity Actual Value	Variable	SIGNED32

Table 137: Object Description (606C_h)

Entry Description							
Sub-index	Name	PDO Mapping	Min	Max	Default	Unit	Access
0	Velocity Actual Value	no	-2147483648	2147483647	0	[rpm]	R

Table 138: Entry Description (606C_h)

6.2.8 Object 607A_h: Target Position

The target position is the position that the drive should move to in profile position mode using the actual settings of motion control parameters (such as velocity, acceleration, deceleration, etc.). The value of this object is interpreted as absolute or relative depending on the abs/rel flag in the controlword.



Object Description			
Index	Name	Object Type	Data Type
607A _h	Target Position	Variable	SIGNED32

Table 139: Object Description (607A_h)

Entry Description							
Sub-index	Name	PDO Mapping	Min	Max	Default	Unit	Access
0	Target Position	no	-2147483648	2147483647	0		RW

Table 140: Entry Description (607A_h)

6.2.9 Object 607D_h: Software Position Limit

This object indicates the configured maximal and minimal software position limits. These parameters define the absolute position limits for the position demand value and the position actual value. Every new target position is checked against these limits. The limit positions are always relative to the machine home position. Before being compared with the target position, they are corrected internally by the home offset as follows:

Corrected min position limit = min position limit - home offset
 Corrected max position limit = max position limit - home offset

Object Description			
Index	Name	Object Type	Data Type
607D _h	Software Position Limit	Array	SIGNED32

Table 141: Object Description (607D_h)

Entry Description							
Sub-index	Name	PDO Mapping	Min	Max	Default	Unit	Access
1	Min Position Limit	no	-2147483648	2147483647	-2147483648		RW
2	Max Position Limit	no	-2147483648	2147483647	2147483647		RW

Table 142: Entry Description (607D_h)

6.2.10 Object 6081_h: Profile Velocity (pp)

This object indicates the configured velocity normally attained at the end of the acceleration ramp during a profiled motion and is valid for both directions of motion. The profile velocity is the maximum velocity used when driving to a new position.



Object Description			
Index	Name	Object Type	Data Type
6081 _h	Profile Velocity (pp)	Variable	UNSIGNED32

Table 143: Object Description (6081_h)

Entry Description							
Sub-index	Name	PDO Mapping	Min	Max	Default	Unit	Access
0	Profile Velocity	no	0	200000	0	[rpm]	RW

Table 144: Entry Description (6081_h)

6.2.11 Object 6082_h: End Velocity

This object indicates the configured velocity normally attained at the end of the deceleration ramp during a profiled motion and is valid for both directions of motion. The end velocity is the velocity used when reaching the new position.

Object Description			
Index	Name	Object Type	Data Type
6082 _h	End Velocity	Variable	SIGNED32

Table 145: Object Description (6082_h)

Entry Description							
Sub-index	Name	PDO Mapping	Min	Max	Default	Unit	Access
0	End Velocity	no	-200000	200000	0	[rpm]	RW

Table 146: Entry Description (6082_h)

6.2.12 Object 6083_h: Profile Acceleration

This object indicates the configured acceleration. Object 6083h sets the maximum acceleration to be used in profile positioning mode, and profile velocity mode.

Object Description			
Index	Name	Object Type	Data Type
6083 _h	Profile Acceleration	Variable	UNSIGNED32

Table 147: Object Description (6083_h)

Entry Description							
Sub-index	Name	PDO Mapping	Min	Max	Default	Unit	Access
0	Profile Acceleration	no	0	100000	2000	[rpm/s]	RW

Table 148: Entry Description (6083_h)

6.2.13 Object 6084_h: Profile Deceleration

This object indicates the configured deceleration.

Object Description			
Index	Name	Object Type	Data Type
6084 _h	Profile Deceleration	Variable	UNSIGNED32

Table 149: Object Description (6084_h)

Entry Description							
Sub-index	Name	PDO Mapping	Min	Max	Default	Unit	Access
0	Profile Deceleration	no	0	100000	2000	[rpm/s]	RW

Table 150: Entry Description (6084_h)

6.2.14 Object 6085_h: Quick Stop Deceleration

This object indicates the configured deceleration used to stop the motor when the quick stop function is activated and the quick stop code object 605A_h is set to 2 (or 6).

Object Description			
Index	Name	Object Type	Data Type
6085 _h	Quick Stop Deceleration	Variable	UNSIGNED32

Table 151: Object Description (6085_h)

Entry Description							
Sub-index	Name	PDO Mapping	Min	Max	Default	Unit	Access
0	Quick Stop Deceleration	no	0	100000	2000	[rpm/s]	RW

Table 152: Entry Description (6085_h)



6.3 How to move a Motor in pp Mode

Here is a little example that shows how to get a motor running in pp mode. In this little example we assume that the module has been reset (and then switched to pre-operational or operational) by NMT commands before. Please note that the values are decimal.

- If you do not have any limit switches connected, first disable the limit switch inputs by writing 3 to object 2005_h.
- Select pp mode by writing 1 to object 6060_h.
- Write 6 to object 6040_h to switch to READY_TO_SWITCH_ON state.
- Write 7 to object 6040_h to switch to SWITCHED_ON state.
- Write 15 to object 6040_h to switch to OPERATION_ENABLED state.
- Write the desired target position (e.g. 500000) to object 607A_h.
- Mark the new target position as active by writing 31 to object 6040_h. The motor starts moving now.
- Reset the activation by writing 15 to object 6040_h (this can be done while the motor is still moving).



7 Profile Velocity Mode

The profile velocity mode is used to control the velocity of the drive without a special regard of the position. It contains limit functions and trajectory generation.

The profile velocity mode covers the following sub-functions:

- Demand value input via trajectory generator.
- Monitoring of the profile velocity using a window-function.
- Monitoring of velocity actual value using a threshold.

The operation of the reference value generator and its input parameters include:

- Profile velocity
- Profile acceleration
- Motion profile type

7.1 Detailed Object Specifications

7.1.1 Object 6040_n: Control Word

This object indicates the received command controlling the power drive system finite state automaton (PDS FSA). The CiA-402 state machine can be controlled using this object. Please refer to figure 4 for detailed information.

In pv mode the control word does not contain any operation mode specific bits.

Structure of the Control Word											
15	11	10	9	8	7	6	4	3	2	1	0
nu	r	r	h	fr	r	eo	qs	ev	so		
MSB						LSB					

Legend: nu=not used; r=reserved; h=halt; fr=fault reset; eo=enable operation; qs=quick stop; ev=enable voltage; so=switch on.

Table 153: Structure of the Control Word in pv Mode



Command Coding						
Command	Bits of Control Word					Transitions
	Bit 7	Bit 3	Bit 2	Bit 1	Bit 0	
Shutdown	0	x	1	1	0	2,6,8
Switch on	0	0	1	1	1	3
Switch on & enable operation	0	1	1	1	1	3, 4
Disable voltage	0	x	x	0	x	7,9,10,12
Quick stop	0	x	0	1	x	7,10,11
Disable operation	0	0	1	1	1	5
Enable operation	0	1	1	1	1	4, 16
Fault reset	0-to-1	x	x	x	x	15

Table 154: Command Coding

Object Description			
Index	Name	Object Type	Data Type
6040 _h	Controlword	Variable	UNSIGNED16

Table 155: Object Description (6040_h in pv Mode)

Entry Description				
Sub-index	Access	PDO Mapping	Value Range	Default Value
0	rw	see CiA402-3	See command coding above.	

Table 156: Entry Description (6040_h in pv Mode)

7.1.2 Object 6041_h: Status Word

This object provides the status of the PDS FSA. It reflects the status of the CiA-402 state machine. Please refer to figure 4 for detailed information. The object is structured as defined below. For more information about the coding please refer to the CANopen Drives and motion control device profile, part 2.

Structure of the Status Word															
15	14	13	12	11	10	9	8	7	6	5	4	3	2	1	0
dir	mot	oms	ila	tr	rm	ms	w	sod	qs	ve	f	oe	so	rtso	
MSB														LSB	

Legend: nu=not used; r=reserved; oms=operation mode specific; h=halt; fr=fault reset; oe=operation enable; qs=quick stop; ve=voltage enable; so=switch on.

Table 157: Structure of the Status Word in pv Mode



Trinamic Specific Bits		
Bit	Name	Definition
14	Motor activity	0: Motor stands still. 1: Motor rotates.
15	Direction of rotation	This bit shows the direction of rotation.

Table 158: Trinamic Specific Bits

Operation Mode specific Bits in pv Mode		
Bit	Name	Definition
10	Target reached	Indicates that the target speed has been reached.
12	Speed	Not supported.
13	Max. slippage error	Not supported.

Table 159: Operation Mode specific Bits in pv Mode

State Coding	
Status word	FSA state
xxxx xxxx x0xx 0000 _h	Not ready to switch on
xxxx xxxx x1xx 0000 _h	Switch on disabled
xxxx xxxx x01x 0001 _h	Ready to switch on
xxxx xxxx x01x 0011 _h	Switched on
xxxx xxxx x01x 0111 _h	Operation enabled
xxxx xxxx x00x 0111 _h	Quick stop active
xxxx xxxx x0xx 1111 _h	Fault reaction active
xxxx xxxx x0xx 1000 _h	Fault

Table 160: State Coding

Object Description			
Index	Name	Object Type	Data Type
6041 _h	Controlword	Variable	UNSIGNED16

Table 161: Object Description (6041_h in pv Mode)



Entry Description				
Sub-index	Access	PDO Mapping	Value Range	Default Value
0	rw	see CiA402-3	See state coding above	

Table 162: Entry Description (6041_h in pv Mode)

7.1.3 Object 6062_h: Position Demand Value

This object provides the demanded position value. The value is given in hall or encoder steps. Object 6062_h indicates the actual position that the motor should have. It is not to be confused with objects 6063_h and 6064_h.

Object Description			
Index	Name	Object Type	Data Type
6062 _h	Position Demand Value	Variable	SIGNED32

Table 163: Object Description (6062_h)

Entry Description							
Sub-index	Name	PDO Mapping	Min	Max	Default	Unit	Access
0	Position Demand Value	no	-2147483648	2147483647	0		R

Table 164: Entry Description (6062_h)

7.1.4 Object 6063_h: Position Actual Internal Value

This object provides the actual position value of the motor.

Object Description			
Index	Name	Object Type	Data Type
6063 _h	Position Actual Internal Value	Variable	SIGNED32

Table 165: Object Description (6063_h)

Entry Description							
Sub-index	Name	PDO Mapping	Min	Max	Default	Unit	Access
0	Position Actual Internal Value	no	-2147483648	2147483647	0		R

Table 166: Entry Description (6063_h)



7.1.5 Object 6064_h: Position Actual Value

This object provides the actual value of the position measurement device. It always contains the same value as object 6063h.

Object Description			
Index	Name	Object Type	Data Type
6064 _h	Position Actual Value	Variable	SIGNED32

Table 167: Object Description (6064_h)

Entry Description							
Sub-index	Name	PDO Mapping	Min	Max	Default	Unit	Access
0	Position Actual Value	no	-2147483648	2147483647	0		R

Table 168: Entry Description (6064_h)

7.1.6 Object 606C_h: Velocity Actual Value

This object shows the actual velocity value derived from the velocity sensor.

Object Description			
Index	Name	Object Type	Data Type
606C _h	Velocity Actual Value	Variable	SIGNED32

Table 169: Object Description (606C_h)

Entry Description							
Sub-index	Name	PDO Mapping	Min	Max	Default	Unit	Access
0	Velocity Actual Value	no	-2147483648	2147483647	0	[rpm]	R

Table 170: Entry Description (606C_h)

7.1.7 Object 607D_h: Software Position Limit

This object indicates the configured maximal and minimal software position limits. These parameters define the absolute position limits for the position demand value and the position actual value. Every new target position is checked against these limits. The limit positions are always relative to the machine home position. Before being compared with the target position, they are corrected internally by the home offset as follows:

Corrected min position limit = min position limit - home offset
 Corrected max position limit = max position limit - home offset



Object Description			
Index	Name	Object Type	Data Type
607D _h	Software Position Limit	Array	SIGNED32

Table 171: Object Description (607D_h)

Entry Description							
Sub-index	Name	PDO Mapping	Min	Max	Default	Unit	Access
1	Min Position Limit	no	-2147483648	2147483647	-2147483648		RW
2	Max Position Limit	no	-2147483648	2147483647	2147483647		RW

Table 172: Entry Description (607D_h)

7.1.8 Object 6083_h: Profile Acceleration

This object indicates the configured acceleration. Object 6083h sets the maximum acceleration to be used in profile positioning mode, and profile velocity mode.

Object Description			
Index	Name	Object Type	Data Type
6083 _h	Profile Acceleration	Variable	UNSIGNED32

Table 173: Object Description (6083_h)

Entry Description							
Sub-index	Name	PDO Mapping	Min	Max	Default	Unit	Access
0	Profile Acceleration	no	0	100000	2000	[rpm/s]	RW

Table 174: Entry Description (6083_h)

7.1.9 Object 6085_h: Quick Stop Deceleration

This object indicates the configured deceleration used to stop the motor when the quick stop function is activated and the quick stop code object 605Ah is set to 2 (or 6).

Object Description			
Index	Name	Object Type	Data Type
6085 _h	Quick Stop Deceleration	Variable	UNSIGNED32

Table 175: Object Description (6085_h)

Entry Description							
Sub-index	Name	PDO Mapping	Min	Max	Default	Unit	Access
0	Quick Stop Deceleration	no	0	100000	2000	[rpm/s]	RW

Table 176: Entry Description (6085_h)

7.1.10 Object 60FF_h: Target Velocity

This object indicates the configured target velocity and is used as input for the trajectory generator. Object 60FF_h sets the target velocity when using profile velocity mode. The drive then accelerates or decelerates to that velocity using the acceleration and deceleration set by objects 6083_h and 6084_h.

Object Description			
Index	Name	Object Type	Data Type
60FF _h	Target Velocity	Variable	SIGNED32

Table 177: Object Description (60FF_h)

Entry Description							
Sub-index	Name	PDO Mapping	Min	Max	Default	Unit	Access
0	Target Velocity	no	-200000	200000	0	[rpm]	RW

Table 178: Entry Description (60FF_h)

7.2 How to move a Motor in pv Mode

Here is a little example that shows how to get a motor running in pv mode. In this little example we assume that the module has been reset (and then switched to pre-operational or operational) by NMT commands before.

- Select pv mode by writing 3 to object 6060_h (Modes_of_Operation).
- Write 6 to object 6040_h (Controlword) to switch to READY_TO_SWITCH_ON state.
- Write 7 to object 6040_h to switch to SWITCHED_ON state.
- Write the desired target velocity (e.g. 2000) to object 60FF_h (Target_Velocity).
- Write 15 to object 6040_h to switch to OPERATION_ENABLED state. The motor now accelerates to the target velocity.
- Stop the motor by writing 0 to object 60FF_h.



8 Homing mode

This chapter describes the method by which a drive seeks the home position (reference point). There are various methods of achieving this using limit switches at the ends of travel or a home switch in mid-travel. Some methods also use the index (zero) pulse train from an incremental encoder. The user may specify the speeds, acceleration and the method of homing.

There is no output data except for those bits in the statusword which return the status or result of the homing process and the demand to the position control loops.

There are four sources of the homing signal available: these are positive and negative limit switches, the home switch and the index pulse from an encoder.

Figure 5 shows the defined input objects as well as the output objects. The user can specify the speeds, acceleration and method of homing. The home offset object 607C_h allows displacing the zero in point the coordinate system for the home position.

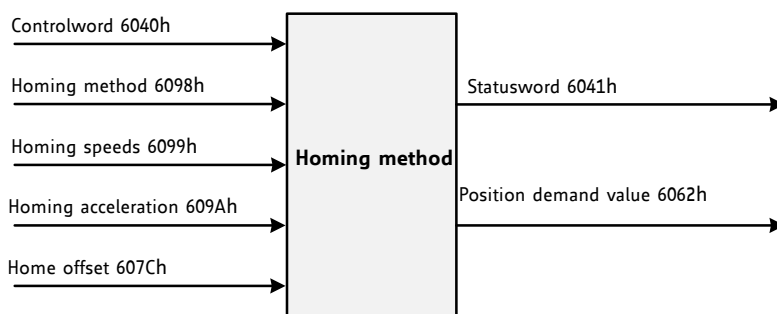

Figure 5: Homing Mode Function

Choosing a homing mode determines the following things:

- The homing signal (positive limit switch, negative limit switch, and home switch).
- The direction of actuation where appropriate.
- The position of the index pulse.

The home position and the zero position are offset by the home offset (see object 607C_h, section 8.2.4).

There are four sources of homing signals available:

- Negative and positive limit switches.
- Home switch.
- Index pulse of an encoder.

For the operation of positioning drives, an exact knowledge of the absolute position is normally required. Since for cost reasons drives often do not have an absolute encoder, a homing operation is necessary.



8.1 Homing Methods

The TMCC160 supports a subset of different standard CANopen homing methods. The homing method that is to be used can be chosen via object 6098_h (section 8.2.5).

Supported Homing Methods	
Method	Description
0	No homing (default value for object 6098 _h).
17	Search the left end switch.
18	Search the right end switch.
35	The actual position is used as home position. All position values (objects 6062h, 6063h, and 6064h) are set to zero, but the motor will not move.

Table 179: Supported CANopen Homing Methods

When using homing methods that need end switch inputs or home switch inputs please take care of their configuration (object 2005_h).

8.1.1 Homing Method 17 and 18: Homing without Index Pulse

These methods are similar to methods 1 to 5 except that the home position is not dependent on the index pulse but only dependent on the relevant home or limit switch transitions.

Homing Methods 17... 21	
Method	Description
17	Search the left end switch. (Similar to method 1)
18	Search the right end switch. (Similar to method 2)

Table 180: Homing Methods 17 – 21

8.1.2 Homing Method 35: Current Position as Home Position

In this method, the current position shall be taken to be the home position. This method does not require the drive device to be in operation enabled state.



8.2 Detailed Object Specifications

8.2.1 Object 6040_h: Control Word

This object indicates the received command controlling the power drive system finite state automaton (PDS FSA). The CiA-402 state machine can be controlled using this object. Please refer to figure 4 for detailed information.

Structure of the Control Word											
15	11	10	9	8	7	6	4	3	2	1	0
nu	r	oms	h	fr	oms	eo	qs	ev	so		
MSB						LSB					

Legend: nu=not used; r=reserved; oms=operation mode specific; h=halt; fr=fault reset; eo=enable operation; qs=quick stop; ev=enable voltage; so=switch on.

Table 181: Structure of the Control Word in hm Mode

Operation Mode specific Bits in hm Mode		
Bit	Name	Definition
4	Homing operation start	1: start homing; 0: stop homing
8	Halt	Not supported.

Table 182: Operation Mode specific Bits in hm Mode

Command Coding						
Command	Bits of Control Word					Transitions
	Bit 7	Bit 3	Bit 2	Bit 1	Bit 0	
Shutdown	0	x	1	1	0	2,6,8
Switch on	0	0	1	1	1	3
Switch on & enable operation	0	1	1	1	1	3, 4
Disable voltage	0	x	x	0	x	7,9,10,12
Quick stop	0	x	0	1	x	7,10,11
Disable operation	0	0	1	1	1	5
Enable operation	0	1	1	1	1	4, 16
Fault reset	0-to-1	x	x	x	x	15

Table 183: Command Coding



Object Description			
Index	Name	Object Type	Data Type
6040 _h	Controlword	Variable	UNSIGNED16

Table 184: Object Description (6040_h in hm Mode)

Entry Description				
Sub-index	Access	PDO Mapping	Value Range	Default Value
0	rw	see CiA402-3	See command coding above.	

Table 185: Entry Description (6040_h in hm Mode)

8.2.2 Object 6041_h: Status Word

This object provides the status of the PDS FSA. It reflects the status of the CiA-402 state machine. Please refer to figure 4 for detailed information. The object is structured as defined below. For more information about the coding please refer to the CANopen Drives and motion control device profile, part 2.

Structure of the Status Word															
15	14	13	12	11	10	9	8	7	6	5	4	3	2	1	0
dir	mot	oms	ila	tr	rm	ms	w	sod	qs	ve	f	oe	so	rtso	
MSB														LSB	

Legend: nu=not used; r=reserved; oms=operation mode specific; h=halt; fr=fault reset; oe=operation enable; qs=quick stop; ve=voltage enable; so=switch on.

Table 186: Structure of the Status Word in hm Mode

Trinamic Specific Bits		
Bit	Name	Definition
14	Motor activity	0: Motor stands still. 1: Motor rotates.
15	Direction of rotation	This bit shows the direction of rotation.

Table 187: Trinamic Specific Bits



Operation Mode specific Bits in hm Mode		
Bit	Name	Definition
10	Target reached	Set when the zero position has been found or homing has been stopped by setting controlword bit 4 to zero.
12	Home attained	Set when zero position has been found.
13	Homing error	Not supported.

Table 188: Operation Mode specific Bits in hm Mode

State Coding	
Status word	FSA state
xxxx xxxx x0xx 0000 _h	Not ready to switch on
xxxx xxxx x1xx 0000 _h	Switch on disabled
xxxx xxxx x01x 0001 _h	Ready to switch on
xxxx xxxx x01x 0011 _h	Switched on
xxxx xxxx x01x 0111 _h	Operation enabled
xxxx xxxx x00x 0111 _h	Quick stop active
xxxx xxxx x0xx 1111 _h	Fault reaction active
xxxx xxxx x0xx 1000 _h	Fault

Table 189: State Coding

Object Description			
Index	Name	Object Type	Data Type
6041 _h	Controlword	Variable	UNSIGNED16

Table 190: Object Description (6041_h in hm Mode)

Entry Description				
Sub-index	Access	PDO Mapping	Value Range	Default Value
0	rw	see CiA402-3	See state coding above.	

Table 191: Entry Description (6041_h in hm Mode)

8.2.3 Object 606C_h: Velocity Actual Value

This object shows the actual velocity value derived from the velocity sensor.



Object Description			
Index	Name	Object Type	Data Type
606C _h	Velocity Actual Value	Variable	SIGNED32

Table 192: Object Description (606C_h)

Entry Description							
Sub-index	Name	PDO Mapping	Min	Max	Default	Unit	Access
0	Velocity Actual Value	no	-2147483648	2147483647	0	[rpm]	R

Table 193: Entry Description (606C_h)

8.2.4 Object 607C_h: Home Offset

This object indicates the configured difference between the zero position for the application and the machine home position/home switch (found during homing). While homing, the machine home position is found and once the homing is completed, the zero position is offset from the home position by adding the home offset to the home position. The effect of setting the home position to a non-zero value depends on the selected homing method. Negative values indicate the opposite direction.

Object Description			
Index	Name	Object Type	Data Type
607C _h	Home Offset	Variable	SIGNED32

Table 194: Object Description (607C_h)

Entry Description							
Sub-index	Name	PDO Mapping	Min	Max	Default	Unit	Access
0	Home Offset	no	-2147483648	2147483647	0		RW

Table 195: Entry Description (607C_h)

8.2.5 Object 6098_h: Homing Method

The actual homing method.

Object Description			
Index	Name	Object Type	Data Type
6098 _h	Homing Method	Variable	SIGNED8

Table 196: Object Description (6098_h)

Entry Description							
Sub-index	Name	PDO Mapping	Min	Max	Default	Unit	Access
0	Homing Method	no	0	35	0		RW

Table 197: Entry Description (6098_h)

8.2.6 Object 6099_h: Homing Speeds

This object indicates the configured speeds used during fast and slow homing procedure. In most homing modes, the home switch is searched with the fast speed first. When the home switch has been found, the motor will be decelerated to the slow speed (using the homing acceleration, object 609A_h) to search for the exact switch point. When the switch point has been found the motor will be stopped at that point.

Object Description			
Index	Name	Object Type	Data Type
6099 _h	Homing Speeds	Array	UNSIGNED32

Table 198: Object Description (6099_h)

Entry Description							
Sub-index	Name	PDO Mapping	Min	Max	Default	Unit	Access
1	Fast Homing Speed	no	0	4294967295	0		RW
2	Slow Homing Speed	no	0	4294967295	0		RW

Table 199: Entry Description (6099_h)

8.2.7 Object 609A_h: Homing Acceleration

This object indicates the configured acceleration and deceleration to be used during homing operation.

Object Description			
Index	Name	Object Type	Data Type
609A _h	Homing Acceleration	Variable	UNSIGNED32

Table 200: Object Description (609A_h)

Entry Description							
Sub-index	Name	PDO Mapping	Min	Max	Default	Unit	Access
0	Homing Acceleration	no	0	100000	2000	[rpm/s]	RW

Table 201: Entry Description (609A_h)

8.2.8 Object 2100_h: Home Offset Display

This object shows the home offset. The value is given in encoder or hall increments.

Object Description			
Index	Name	Object Type	Data Type
2100 _h	Home Offset Display	Variable	SIGNED32

Table 202: Object Description (2100_h)

Entry Description							
Sub-index	Name	PDO Mapping	Min	Max	Default	Unit	Access
0	Home Offset Display	no	-2147483648	2147483647	0		R

Table 203: Entry Description (2100_h)



8.3 How to start a Homing in hm Mode

Here is a little example that shows how to home the motor in hm mode. In this little example we assume that the module has been reset (and then switched to pre-operational or operational) by NMT commands before. The home switch must be connected to the home switch input. It can be operated manually.

- Select hm mode by writing 6 to object 6060_h.
- Write 6 to object 6040_h to switch to READY_TO_SWITCH_ON state.
- Write 7 to object 6040_h to switch to SWITCHED_ON state.
- Write 15 to object 6040_h to switch to OPERATION_ENABLED state.
- Select homing method 17 (or 18) by writing 17 (or 18) to object 6098_h.
- Set the homing speeds by writing e.g. 500 to object 6099_h sub index 1 and e.g. 200 to object 6099_h sub index 2.
- Write 31 to object 6040_h to start the homing process.
- Press and release the home switch.
- When homing has finished, write 15 to object 6040_h again.



9 Cyclic synchronous Torque Mode

The cyclic synchronous torque mode is used to directly control the torque of the motor, without the need for position or velocity control. It contains limit functions, but not a trajectory generator.

The cyclic synchronous torque mode covers the following sub-functions:

- Demand value input directly via an object.
- Monitoring of the torque.
- Limiting the position using the software limits or the hardware limit switches.

9.1 Detailed Object Specifications

9.1.1 Object 6040_n: Control Word

This object indicates the received command controlling the power drive system finite state automaton (PDS FSA). The CiA-402 state machine can be controlled using this object. Please refer to figure 4 for detailed information. The cyclic synchronous torque mode does not use any mode specific bits of the control word.

Structure of the Control Word									
15	9	8	7	6	4	3	2	1	0
nu	h	fr	nu	eo	qs	ev	so		
MSB					LSB				

Legend: nu=not used; h=halt; fr=fault reset; eo=enable operation; qs=quick stop; ev=enable voltage; so=switch on.

Table 204: Structure of the Control Word in cst Mode

Command Coding						
Command	Bits of Control Word					Transitions
	Bit 7	Bit 3	Bit 2	Bit 1	Bit 0	
Shutdown	0	x	1	1	0	2,6,8
Switch on	0	0	1	1	1	3
Switch on & enable operation	0	1	1	1	1	3, 4
Disable voltage	0	x	x	0	x	7,9,10,12
Quick stop	0	x	0	1	x	7,10,11
Disable operation	0	0	1	1	1	5
Enable operation	0	1	1	1	1	4, 16
Fault reset	0-to-1	x	x	x	x	15

Table 205: Command Coding



Object Description			
Index	Name	Object Type	Data Type
6040 _h	Controlword	Variable	UNSIGNED16

Table 206: Object Description (6040_h in cst Mode)

Entry Description				
Sub-index	Access	PDO Mapping	Value Range	Default Value
0	rw	see CiA402-3	See command coding above.	

Table 207: Entry Description (6040_h in cst Mode)

9.1.2 Object 6041_h: Status Word

This object provides the status of the PDS FSA. It reflects the status of the CiA-402 state machine. Please refer to figure 4 for detailed information. The object is structured as defined below.

For more information about the coding please refer to the CANopen Drives and motion control device profile, part 2.

Structure of the Status Word															
15	14	13	12	11	10	9	8	7	6	5	4	3	2	1	0
dir	mot	oms	ila	r	rm	ms	w	sod	qs	ve	f	oe	so	rtso	
MSB														LSB	

Legend: nu=not used; r=reserved; oms=operation mode specific; h=halt; fr=fault reset; oe=operation enable; qs=quick stop; ve=voltage enable; so=switch on.

Table 208: Structure of the Status Word in cst Mode

Trinamic Specific Bits		
Bit	Name	Definition
14	Motor activity	0: Motor stands still. 1: Motor rotates.
15	Direction of rotation	This bit shows the direction of rotation.

Table 209: Trinamic Specific Bits



Operation Mode specific Bits in cst Mode		
Bit	Name	Definition
10	Reserved	Not used.
12	Target torque ignored	0: Target torque ignored. 1: Target torque used as input to control loop.
13	Reserved	Not used.

Table 210: Operation Mode specific Bits in cst Mode

State Coding	
Status word	FSA state
xxxx xxxx x0xx 0000 _h	Not ready to switch on
xxxx xxxx x1xx 0000 _h	Switch on disabled
xxxx xxxx x01x 0001 _h	Ready to switch on
xxxx xxxx x01x 0011 _h	Switched on
xxxx xxxx x01x 0111 _h	Operation enabled
xxxx xxxx x00x 0111 _h	Quick stop active
xxxx xxxx x0xx 1111 _h	Fault reaction active
xxxx xxxx x0xx 1000 _h	Fault

Table 211: State Coding

Object Description			
Index	Name	Object Type	Data Type
6041 _h	Controlword	Variable	UNSIGNED16

Table 212: Object Description (6041_h in cst Mode)

Entry Description				
Sub-index	Access	PDO Mapping	Value Range	Default Value
0	rw	see CiA402-3	See state coding above	

Table 213: Entry Description (6041_h in cst Mode)

9.1.3 Object 6071_h: Target Torque

This object gives the target motor current.



Object Description			
Index	Name	Object Type	Data Type
6071 _h	Target Torque	Variable	SIGNED32

Table 214: Object Description (6071_h)

Entry Description							
Sub-index	Name	PDO Mapping	Min	Max	Default	Unit	Access
0	Target Torque	no	-90000	90000	0	[mA]	RW

Table 215: Entry Description (6071_h)

9.1.4 Object 6077_h: Torque Actual Value

The actual motor current.

Object Description			
Index	Name	Object Type	Data Type
6077 _h	Torque Actual Value	Variable	SIGNED32

Table 216: Object Description (6077_h)

Entry Description							
Sub-index	Name	PDO Mapping	Min	Max	Default	Unit	Access
0	Torque Actual Value	no	-2147483648	2147483647	0		R

Table 217: Entry Description (6077_h)

9.1.5 Object 60B2_h: Torque offset

The actual set torque offset.

Object Description			
Index	Name	Object Type	Data Type
60B2 _h	Torque offset	Variable	SIGNED32

Table 218: Object Description (60B2_h)



Entry Description							
Sub-index	Name	PDO Mapping	Min	Max	Default	Unit	Access
0	Torque offset	no	-2147483648	2147483647	0		RW

Table 219: Entry Description (60B2_h)



9.2 How to move a Motor in cst Mode

Here is a little example that shows how to get a motor running in cst mode. In this little example we assume that the module has been reset (and then switched to start) by NMT commands before.

- If you do not have any limit switches connected, first disable the limit switch inputs by writing 3 to object 2005_h.
- Select cst mode by writing 10 to object 6060_h.
- Write 6 to object 6040_h to switch to READY_TO_SWITCH_ON state.
- Write 7 to object 6040_h to switch to SWITCHED_ON state.
- Write 15 to object 6040_h to switch to OPERATION_ENABLED state.
- Write the desired torque (e.g. 1000) to object 6071_h to start the motor.
- To stop the motor, write 0 to object 6071_h.



10 Emergency Messages (EMCY)

The module sends an emergency message if an error occurs. The message contains information about the error type. The module can map internal errors and object 1001_h (error register) is part of every emergency object.

Emergency Messages (EMCY) of the TMCC160						
Error code	Additional byte					Description
	1	2	3	4	5	
0000 _h	0	0	0	0	0	Fault reset The fault reset command has been executed.
1000 _h	1	0	0	0	0	Generic error: open load bridge A The motor driver indicates open load on bridge A. It is possible that the motor cable is broken or that there is an error in the power amplifier itself.
1000 _h	2	0	0	0	0	Generic error: open load bridge B The motor driver indicates open load on bridge B. It is possible that the motor cable is broken or that there is an error in the power amplifier itself.
2310 _h	0	0	0	0	0	Overcurrent high side The motor driver indicates an overcurrent on the high side. This can be caused by a short circuit in the driver stage.
2311 _h	0	0	0	0	0	Overcurrent bridge B The motor driver indicates that there is overcurrent on bridge B. This can be caused by a short circuit in the motor itself or in the motor driver stage.
2312 _h	0	0	0	0	0	Overcurrent bridge A The motor driver indicates that there is overcurrent on bridge A. This can be caused by a short circuit in the motor itself or in the motor driver stage.
3230 _h	0	0	0	0	0	stallGuard2 error The actual load value exceeds the stallGuard2 limit.
4310 _h	1	0	0	0	0	Overtemperature pre-warning The temperature in the motor driver exceeds the pre-warning limit.
4310 _h	2	0	0	0	0	Overtemperature error The motor driver has been switched off because the temperature limit has been exceeded.
5441 _h	0	255	0	0	0	Shutdown switch active The enable signal is missing (due to the shutdown switch) and the motor driver has been switched off.
6320 _h	0	255	0	0	0	Parameter error The data in the received PDO is either wrong or cannot be accepted due to the internal state of the drive.



Error code	Additional byte					Description
	1	2	3	4	5	
8110 _h	1	255	0	0	0	CAN controller overflow The receive message buffer of the CAN controller hardware is full and some CAN messages are lost.
8110 _h	2	255	0	0	0	CAN Tx buffer overflow The software CAN transmit buffer is full and thus some CAN messages are lost.
8110 _h	3	255	0	0	0	CAN Rx buffer overflow The software CAN receive buffer is full and so some CAN messages are lost.
8120 _h	0	255	0	0	0	CAN error passive The CAN controller has detected communication errors and has entered the CAN Error passive state.
8140 _h	0	255	0	0	0	CAN controller recovered from bus-off state The CAN controller has detected too many errors and has changed into the bus-off state. The drive has been stopped and disabled. This message is sent after the CAN controller has recovered from bus-off state and is bus-on again.
8611 _h	0	0	0	0	0	Following error The deviation between motor position counter and encoder position counter has exceeded the following error window.
ff00 _h	0	0	0	0	0	Undervoltage The supply voltage is too low to drive a motor.
ff01 _h	1	0	0	0	0	Positive software limit The actual position is outside the range defined by object 607d _h .
ff01 _h	2	0	0	0	0	Negative software limit The actual position is outside the range defined by object 607d _h .
ff01 _h	3	0	0	0	0	Positive limit switch The positive limit switch has been touched outside of the homing function.
ff01 _h	4	0	0	0	0	Negative limit switch The negative limit switch has been touched outside of the homing function.

Table 220: Emergency Messages (EMCY)



11 Figures Index

1	NMT State Machine	10	4	DS402 Finite State Machine	45
2	Communication Architecture	11			
3	Device Model	12	5	Homing Mode Function	63



12 Tables Index

1	Abbreviations used in this Manual . . .	7	53	Entry Description (200E _h)	28
2	Service Primitives	8	54	Object Description (200F _h)	28
3	Service Types	9	55	Entry Description (200F _h)	28
4	Object Dictionary	12	56	Object Description (2010 _h)	28
5	Object Description (1000 _h)	13	57	Entry Description (2010 _h)	28
6	Entry Description (1000 _h)	13	58	Object Description (2020 _h)	29
7	Object Description (1001 _h)	13	59	Entry Description (2020 _h)	29
8	Entry Description (1001 _h)	14	60	Object Description (2030 _h)	29
9	Error Register Bits	14	61	Entry Description (2030 _h)	29
10	Value Definition (1005 _h)	14	62	Object Description (2040 _h)	30
11	Object Description (1005 _h)	14	63	Entry Description (2040 _h)	30
12	Entry Description (1005 _h)	15	64	Object Description (2050 _h)	30
13	Object Description (1008 _h)	15	65	Entry Description (2050 _h)	31
14	Entry Description (1008 _h)	15	66	Object Description (2055 _h)	31
15	Object Description (1009 _h)	15	67	Entry Description (2055 _h)	31
16	Entry Description (1009 _h)	15	68	Object Description (2056 _h)	31
17	Object Description (100A _h)	16	69	Entry Description (2056 _h)	32
18	Entry Description (100A _h)	16	70	Object Description (2060 _h)	32
19	Object Description (100C _h)	16	71	Entry Description (2060 _h)	32
20	Entry Description (100C _h)	16	72	Object Description (2070 _h)	32
21	Object Description (100D _h)	16	73	Entry Description (2070 _h)	32
22	Entry Description (100D _h)	17	74	Object Description (2080 _h)	33
23	Save Signature	17	75	Entry Description (2080 _h)	33
24	Object Description (1010 _h)	17	76	Object Description (2090 _h)	33
25	Entry Description (1010 _h)	18	77	Entry Description (2090 _h)	33
26	Load Signature	18	78	Object Description (2095 _h)	34
27	Object Description (1011 _h)	19	79	Entry Description (2095 _h)	34
28	Entry Description (1011 _h)	19	80	Object Description (2100 _h)	34
29	Object Description (1014 _h)	19	81	Entry Description (2100 _h)	34
30	Entry Description (1014 _h)	19	82	Object Description (2702 _h)	35
31	Object Description (1015 _h)	19	83	Entry Description (2702 _h)	35
32	Entry Description (1015 _h)	20	84	Object Description (2704 _h)	35
33	Value Definition (1016 _h)	20	85	Entry Description (2704 _h)	35
34	Object Description (1016 _h)	20	86	Object Description (2705 _h)	36
35	Entry Description (1016 _h)	20	87	Entry Description (2705 _h)	36
36	Object Description (1017 _h)	21	88	Object Description (2706 _h)	36
37	Entry Description (1017 _h)	21	89	Entry Description (2706 _h)	36
38	Object Description (1018 _h)	21	90	Object Description (2707 _h)	36
39	Entry Description (1018 _h)	21	91	Entry Description (2707 _h)	37
40	Object Description (1029 _h)	22	92	Object Description (2708 _h)	37
41	Entry Description (1029 _h)	22	93	Entry Description (2708 _h)	37
42	Object Description (1400 _h)	22	94	Object Description (270E _h)	37
43	Entry Description (1400 _h)	23	95	Entry Description (270E _h)	38
44	Object Description (1600 _h)	23	96	Object Description (605A _h)	39
45	Entry Description (1600 _h)	24	97	Entry Description (605A _h)	39
46	Object Description (1800 _h)	25	98	Object Description (605B _h)	39
47	Entry Description (1800 _h)	25	99	Entry Description (605B _h)	39
48	Object Description (1A00 _h)	26	100	Object Description (605C _h)	40
49	Entry Description (1A00 _h)	26	101	Entry Description (605C _h)	40
50	Object Description (200D _h)	27	102	Object Description (605D _h)	40
51	Entry Description (200D _h)	27	103	Entry Description (605D _h)	40
52	Object Description (200E _h)	27	104	Object Description (605E _h)	41



105	Entry Description (605E _h)	41	157	Structure of the Status Word in pv Mode	56
106	Object Description (6060 _h)	41	158	Trinamic Specific Bits	57
107	Entry Description (6060 _h)	41	159	Operation Mode specific Bits in pv Mode	57
108	Object Description (6061 _h)	42	160	State Coding	57
109	Entry Description (6061 _h)	42	161	Object Description (6041 _h in pv Mode)	57
110	Object Description (608F _h)	42	162	Entry Description (6041 _h in pv Mode)	58
111	Entry Description (608F _h)	42	163	Object Description (6062 _h)	58
112	Object Description (6099 _h)	43	164	Entry Description (6062 _h)	58
113	Entry Description (6099 _h)	43	165	Object Description (6063 _h)	58
114	Object Description (60FD _h)	43	166	Entry Description (6063 _h)	58
115	Entry Description (60FD _h)	43	167	Object Description (6064 _h)	59
116	Object Description (6502 _h)	44	168	Entry Description (6064 _h)	59
117	Entry Description (6502 _h)	44	169	Object Description (606C _h)	59
118	Structure of the Control Word in pp Mode	46	170	Entry Description (606C _h)	59
119	Operation Mode specific Bits in pp Mode	46	171	Object Description (607D _h)	60
120	Command Coding	46	172	Entry Description (607D _h)	60
121	Object Description (6040 _h in pp Mode)	46	173	Object Description (6083 _h)	60
122	Entry Description (6040 _h in pp Mode)	47	174	Entry Description (6083 _h)	60
123	Structure of the Staus Word in pp Mode	47	175	Object Description (6085 _h)	60
124	Trinamic Specific Bits	47	176	Entry Description (6085 _h)	61
125	Operation Mode specific Bits in pp Mode	47	177	Object Description (60FF _h)	61
126	State Coding	48	178	Entry Description (60FF _h)	61
127	Object Description (6041 _h in pp Mode)	48	179	Supported CANopen Homing Methods	64
128	Entry Description (6041 _h in pp Mode)	48	180	Homing Methods 17 – 21	64
129	Object Description (6062 _h)	48	181	Structure of the Control Word in hm Mode	65
130	Entry Description (6062 _h)	49	182	Operation Mode specific Bits in hm Mode	65
131	Object Description (6063 _h)	49	183	Command Coding	65
132	Entry Description (6063 _h)	49	184	Object Description (6040 _h in hm Mode)	66
133	Object Description (6064 _h)	49	185	Entry Description (6040 _h in hm Mode)	66
134	Entry Description (6064 _h)	49	186	Structure of the Status Word in hm Mode	66
135	Object Description (6067 _h)	50	187	Trinamic Specific Bits	66
136	Entry Description (6067 _h)	50	188	Operation Mode specific Bits in hm Mode	67
137	Object Description (606C _h)	50	189	State Coding	67
138	Entry Description (606C _h)	50	190	Object Description (6041 _h in hm Mode)	67
139	Object Description (607A _h)	51	191	Entry Description (6041 _h in hm Mode)	67
140	Entry Description (607A _h)	51	192	Object Description (606C _h)	68
141	Object Description (607D _h)	51	193	Entry Description (606C _h)	68
142	Entry Description (607D _h)	51	194	Object Description (607C _h)	68
143	Object Description (6081 _h)	52	195	Entry Description (607C _h)	68
144	Entry Description (6081 _h)	52	196	Object Description (6098 _h)	68
145	Object Description (6082 _h)	52	197	Entry Description (6098 _h)	69
146	Entry Description (6082 _h)	52	198	Object Description (6099 _h)	69
147	Object Description (6083 _h)	52	199	Entry Description (6099 _h)	69
148	Entry Description (6083 _h)	53	200	Object Description (609A _h)	69
149	Object Description (6084 _h)	53	201	Entry Description (609A _h)	70
150	Entry Description (6084 _h)	53	202	Object Description (2100 _h)	70
151	Object Description (6085 _h)	53	203	Entry Description (2100 _h)	70
152	Entry Description (6085 _h)	53	204	Structure of the Control Word in cst Mode	72
153	Structure of the Control Word in pv Mode	55	205	Command Coding	72
154	Command Coding	56	206	Object Description (6040 _h in cst Mode)	73
155	Object Description (6040 _h in pv Mode)	56			
156	Entry Description (6040 _h in pv Mode)	56			



207	Entry Description (6040 _h in cst Mode)	73	215	Entry Description (6071 _h)	75
208	Structure of the Status Word in cst Mode	73	216	Object Description (6077 _h)	75
209	Trinamic Specific Bits	73	217	Entry Description (6077 _h)	75
210	Operation Mode specific Bits in cst Mode	74	218	Object Description (60B2 _h)	75
211	State Coding	74	219	Entry Description (60B2 _h)	76
212	Object Description (6041 _h in cst Mode)	74	220	Emergency Messages (EMCY)	79
213	Entry Description (6041 _h in cst Mode)	74	221	Firmware Revision	86
214	Object Description (6071 _h)	75	222	Document Revision	86



13 Supplemental Directives

13.1 Producer Information

13.2 Copyright

TRINAMIC owns the content of this user manual in its entirety, including but not limited to pictures, logos, trademarks, and resources. © Copyright 2017 TRINAMIC. All rights reserved. Electronically published by TRINAMIC, Germany.

Redistributions of source or derived format (for example, Portable Document Format or Hypertext Markup Language) must retain the above copyright notice, and the complete Datasheet User Manual documentation of this product including associated Application Notes; and a reference to other available product-related documentation.

13.3 Trademark Designations and Symbols

Trademark designations and symbols used in this documentation indicate that a product or feature is owned and registered as trademark and/or patent either by TRINAMIC or by other manufacturers, whose products are used or referred to in combination with TRINAMIC's products and TRINAMIC's product documentation.

This CANopen® Firmware Manual is a non-commercial publication that seeks to provide concise scientific and technical user information to the target user. Thus, trademark designations and symbols are only entered in the Short Spec of this document that introduces the product at a quick glance. The trademark designation /symbol is also entered when the product or feature name occurs for the first time in the document. All trademarks and brand names used are property of their respective owners.

13.4 Target User

The documentation provided here, is for programmers and engineers only, who are equipped with the necessary skills and have been trained to work with this type of product.

The Target User knows how to responsibly make use of this product without causing harm to himself or others, and without causing damage to systems or devices, in which the user incorporates the product.

13.5 Disclaimer: Life Support Systems

TRINAMIC Motion Control GmbH & Co. KG does not authorize or warrant any of its products for use in life support systems, without the specific written consent of TRINAMIC Motion Control GmbH & Co. KG.

Life support systems are equipment intended to support or sustain life, and whose failure to perform, when properly used in accordance with instructions provided, can be reasonably expected to result in personal injury or death.

Information given in this document is believed to be accurate and reliable. However, no responsibility is assumed for the consequences of its use nor for any infringement of patents or other rights of third parties which may result from its use. Specifications are subject to change without notice.

13.6 Disclaimer: Intended Use

The data specified in this user manual is intended solely for the purpose of product description. No representations or warranties, either express or implied, of merchantability, fitness for a particular purpose



or of any other nature are made hereunder with respect to information/specification or the products to which information refers and no guarantee with respect to compliance to the intended use is given.

In particular, this also applies to the stated possible applications or areas of applications of the product. TRINAMIC products are not designed for and must not be used in connection with any applications where the failure of such products would reasonably be expected to result in significant personal injury or death (safety-Critical Applications) without TRINAMIC's specific written consent.

TRINAMIC products are not designed nor intended for use in military or aerospace applications or environments or in automotive applications unless specifically designated for such use by TRINAMIC. TRINAMIC conveys no patent, copyright, mask work right or other trade mark right to this product. TRINAMIC assumes no liability for any patent and/or other trade mark rights of a third party resulting from processing or handling of the product and/or any other use of the product.

13.7 Collateral Documents & Tools

This product documentation is related and/or associated with additional tool kits, firmware and other items, as provided on the product page at: www.trinamic.com.



14 Revision History

14.1 Firmware Revision

Version	Date	Author	Description
3.00	29.08.2017	ED	First release.

Table 221: Firmware Revision

14.2 Document Revision

Version	Date	Author	Description
1.00	29.08.2017	ED	First release.

Table 222: Document Revision

