

### Application Note

## Ceramic Quad Band Monopole Antenna

GSM850 or EGSM900

PCN1800, PCS1900 and WCDMA I

10 mm x 3.2 mm x 4 mm Ceramic Chip Antenna

Ground Cleared Under Antenna:  
40 mm x 10 mm

Pulse Part Number: W3073

Version 1: GSM850, PCN1800, PCS1900 and WCDMA I  
Version 2: EGSM900, PCN1800, PCS1900 and WCDMA I

### Status

Author	MiJu	Version	1.0.0
Checked by		Date	22.02.2010
Approved by		Date	

#### Pulse Finland Oy

Takatie 6  
90440 Kempele, Finland  
Tel: +358 207 935 500

Domicile: Kempele  
Business ID: 1933992-8  
[firstname.lastname@pulseeng.com](mailto:firstname.lastname@pulseeng.com)

# Table of Content

General Features and Applications .....	3
Terminal configuration and antenna dimensions.....	4
Test setup for electrical measurements .....	5
Electrical performance test results.....	8
Packing .....	15
Mechanical Outline .....	18
Contact information .....	19

# Ceramic Chip Antenna

Ground Cleared Under Antenna

## Features

- Low profile
- Compact size W x L x H (10 x 3.2 x 4 mm)
- Low weight (600 mg)
- Lead free materials
- Fully SMD compatible
- Lead free soldering compatible
- Tape and reel packing
- RoHS Compliant Product

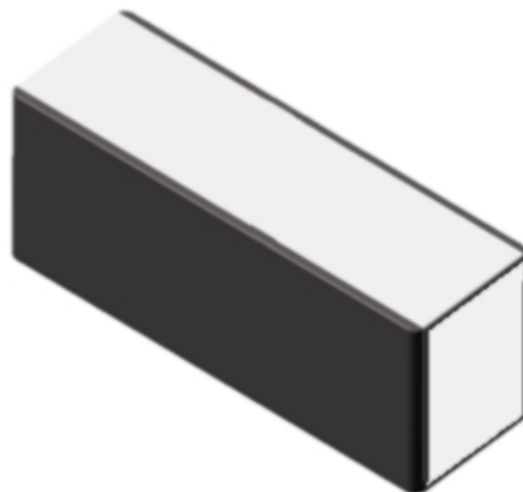

## Applications

Version 1: GSM850, PCN1800, PCS1900 and WCDMA I- radios

Version 2: EGSM900, PCN1800, PCS1900 and WCDMA I- radios

## Electrical specifications @ +25 °C

Note: Electrical characteristics depend on test board ground plane (GP) size, antenna positioning on GP and Ground Clearance area size.

### Version 1: W3073 Ceramic Quad Band Monopole Antenna (Ground Cleared Under Antenna 40 mm x 10mm)

Typical performance (test board size 105 mm x 40 mm, PWB ground clearance area 40 mm x 10 mm)

10nH and 12nH series-inductors used for frequency tuning and 12nH shunt-inductor used for impedance matching.

Frequency Range [MHz]	3D Max Gain [dBi]	3D Efficiency [%] / [dB]	Return loss at band edges [dB]	Impedance [Ω]	Operating Temperature [°C]
824 - 894	-2.6 ; -1.76 (band edges) 0.4 (peak)	28/-5.5 ; 33/-4.8 (band edges) 51/-2.9 (peak)	-4.7 ; -5.9	50	-40 to +85
1710 – 1880	0.7 ; 2.3 (band edges) 2.3 (peak)	40/-4.0 ; 59/-2.3 (band edges) 59/-2.3 (peak)	-3.5 ; -6.7	50	-40 to +85
1850 – 1990	2.2 ; 1.6 (band edges) 2.5 (peak)	59/-2.3 ; 54/-2.7 (band edges) 59/-2.3 (peak)	-6.5 ; -5.9	50	-40 to +85
1920 - 2170	2.2 ; 0.9 (band edges) 2.2 (peak)	58/-2.3 ; 46/-3.4 (band edges) 58/-2.3 (peak)	-6.6 ; -3.3	50	-40 to +85

### Version 2: W3073 Ceramic Quad Band Monopole Antenna (Ground Cleared Under Antenna 40 mm x 10mm)

Typical performance (test board size 105 mm x 40 mm, PWB ground clearance area 40 mm x 10 mm)

2pcs of 10nH series-inductors used for frequency tuning and 15nH shunt-inductor used for impedance matching.

Frequency Range [MHz]	3D Max Gain [dBi]	3D Efficiency [%] / [dB]	Return loss at band edges [dB]	Impedance [Ω]	Operating Temperature [°C]
880 - 960	-0.5 ; -1.8 (band edges) 1.0 (peak)	41/-3.8 ; 34/-4.7 (band edges) 60/-2.2 (peak)	-4.5 ; -3.8	50	-40 to +85
1710 – 1880	2.0 ; 2.8 (band edges) 2.9 (peak)	54/-2.7 ; 70/-1.6 (band edges) 70/-1.6 (peak)	-4.9 ; -9.1	50	-40 to +85
1850 – 1990	2.9 ; 2.5 (band edges) 2.9 (peak)	69/-1.6 ; 62/-2.1 (band edges) 71/-1.5 (peak)	-8.9 ; -8.0	50	-40 to +85
1920 - 2170	2.7 ; 2.3 (band edges) 2.8 (peak)	65/-1.9 ; 59/-2.3 (band edges) 67/-1.7 (peak)	-9.3 ; -4.4	50	-40 to +85

## Pulse Finland Oy

Takatie 6  
90440 Kempele, Finland  
Tel: +358 207 935 500

Domicile: Kempele  
Business ID: 1933992-8  
[firstname.lastname@pulseeng.com](mailto:firstname.lastname@pulseeng.com)

# Ceramic Chip Antenna

## Terminal Configuration and Antenna Dimensions

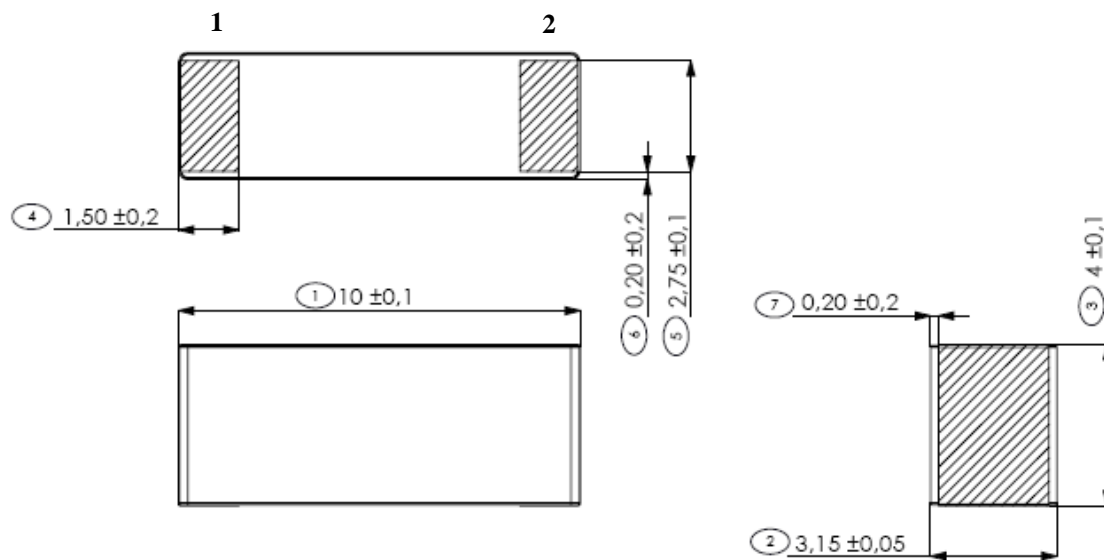

No.	Terminal Name	Terminal Dimensions
1	Feed	1.5 x 2.75 mm
2	Support pad	1.5 x 2.75 mm
Antenna is symmetrical and orientation on footprint can be rotated 180 degrees without change in performance		

# Ceramic Chip Antenna

## Test Setup for Electrical Measurements

Recommended test board- layout for electrical characteristic measurement. Test board outline size 105 x 40mm. Ground cleared under antenna 40mm x 10mm.

Version 1: GSM850, PCN1800, PCS1900 and WCDMA I

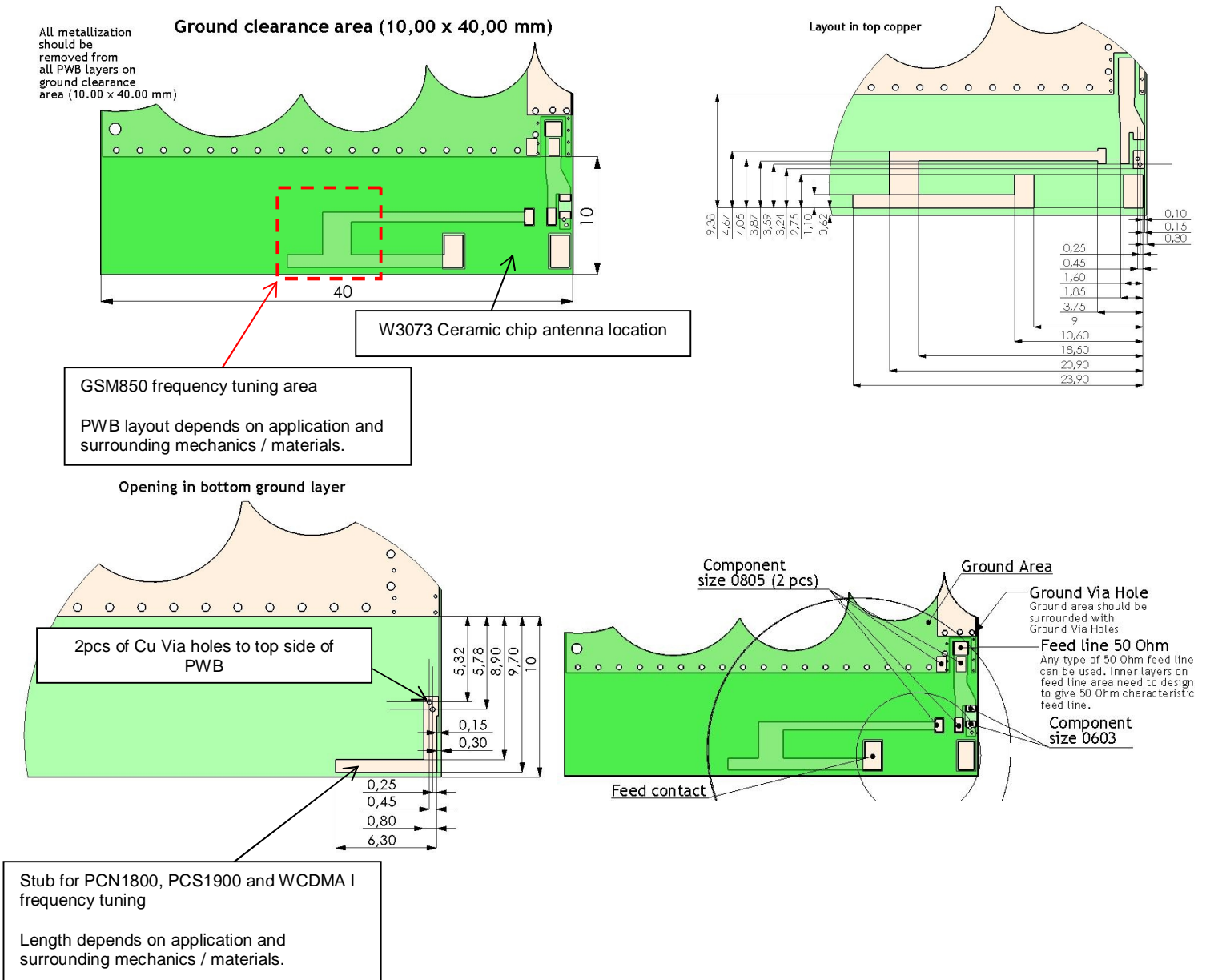

Version 2: EGSM900, PCN1800, PCS1900 and WCDMA I

All metallization should be removed from all PWB layers on ground clearance area (10,00 x 40,00 mm)

Ground clearance area (10,00 x 40,00 mm)

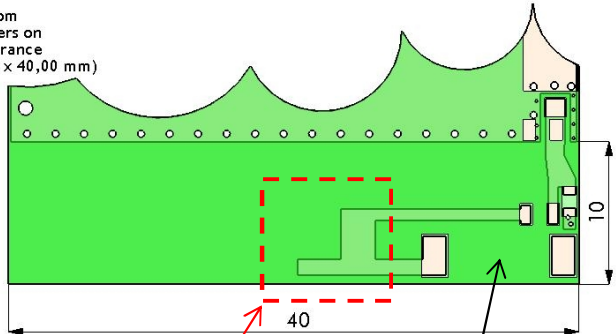

W3073 Ceramic chip antenna location

EGSM900 frequency tuning area  
PWB layout depends on application and surrounding mechanics / materials.

Opening in bottom ground layers

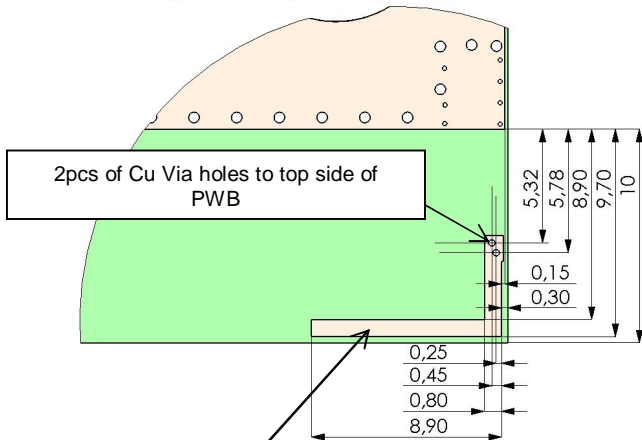

Stub for PCN1800, PCS1900 and WCDMA I frequency tuning  
Length depends on application and surrounding mechanics / materials.

Pad dimensions in top copper

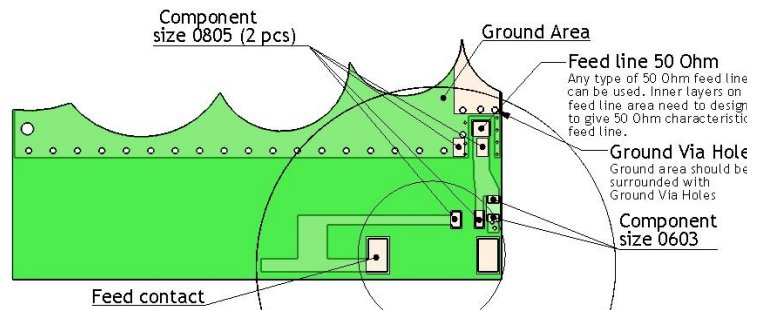
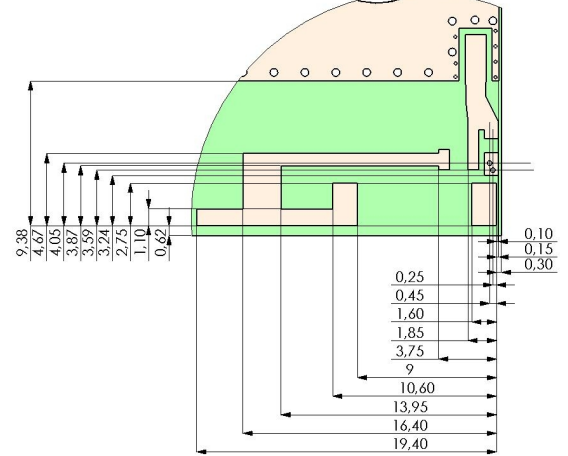

Recommended test board- layout for electrical characteristic measurement. Test board outline size 105 x 40mm. Ground cleared under antenna 40mm x 10mm.

3D- view of Test Setup

Version 1: GSM850, PCN1800, PCS1900 and WCDMA I

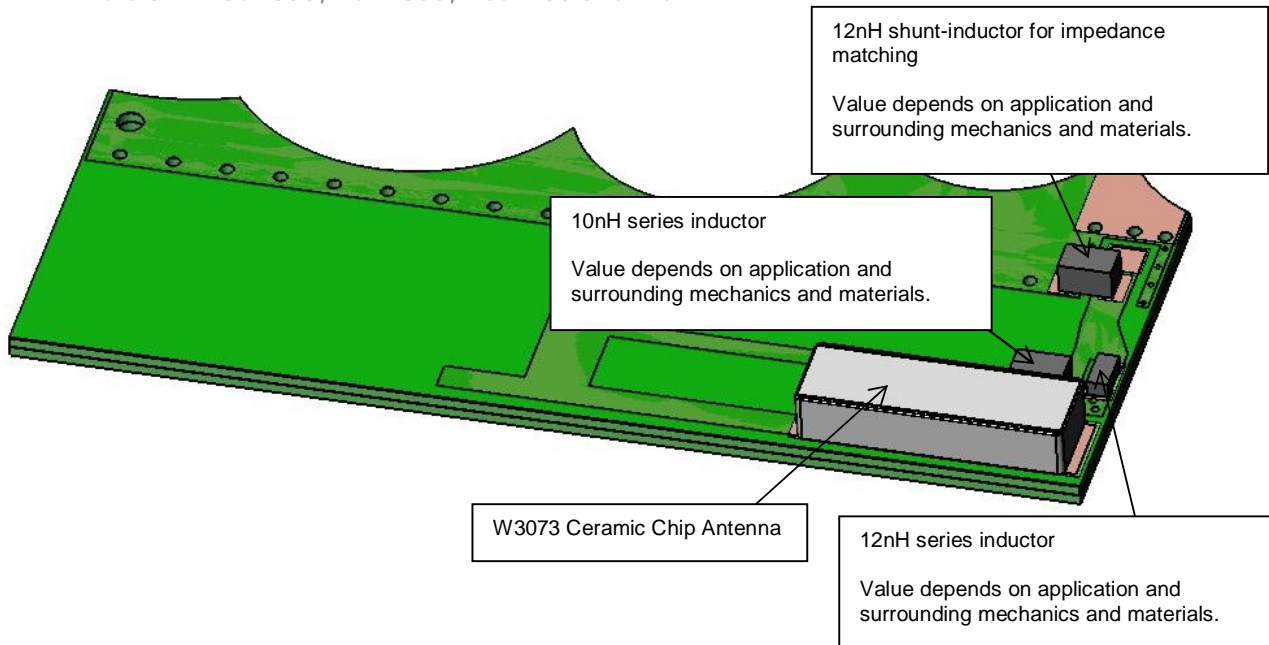

3D- view of Test Setup

Version 2: EGSM900, PCN1800, PCS1900 and WCDMA I

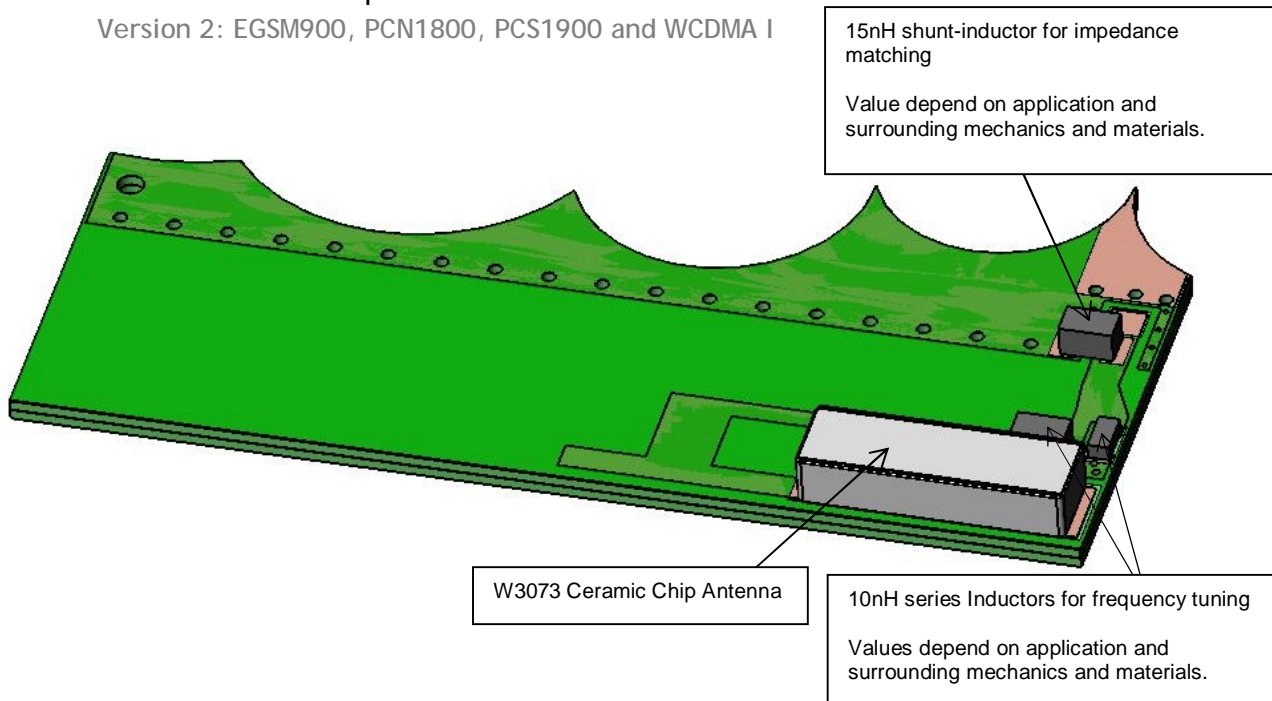

# Ceramic Chip Antenna

## Typical Electrical Characteristics (T=25 °C)

Measured with test board outline size 105 x 40mm. Ground cleared under antenna 40mm x 10mm.

Version 1: Typical Return Loss S11

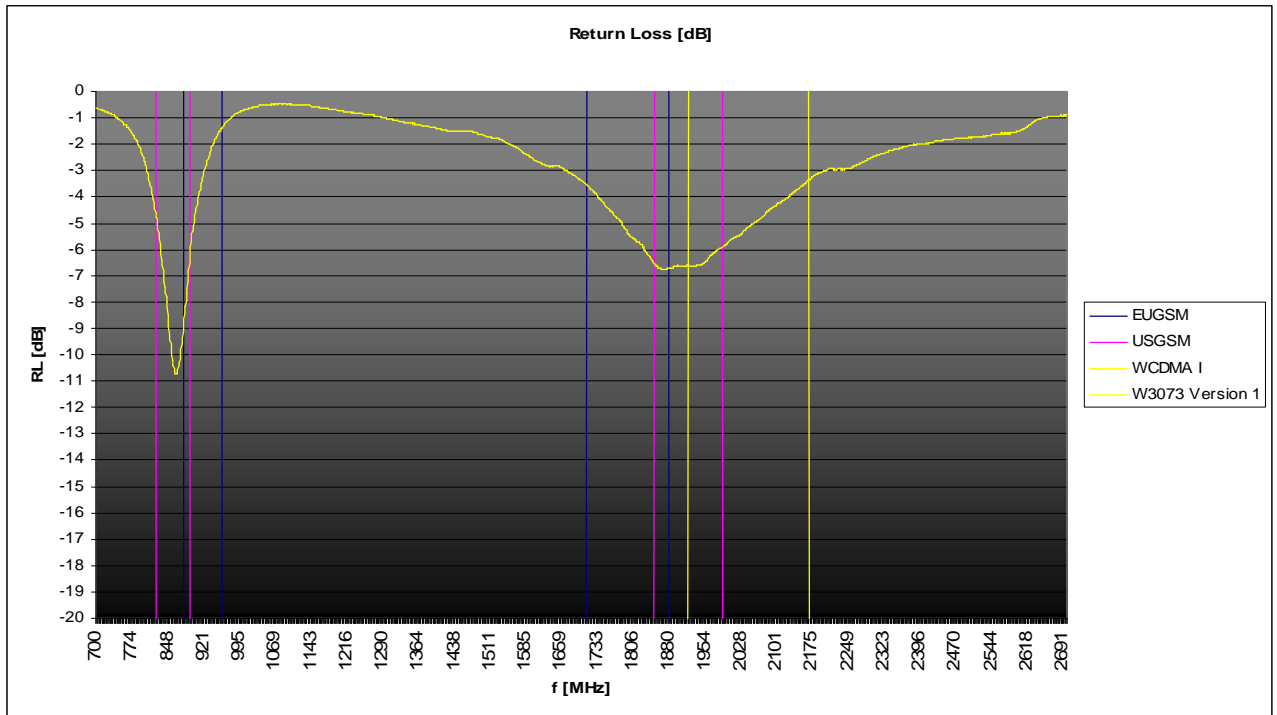

Version 2: Typical Return Loss S11

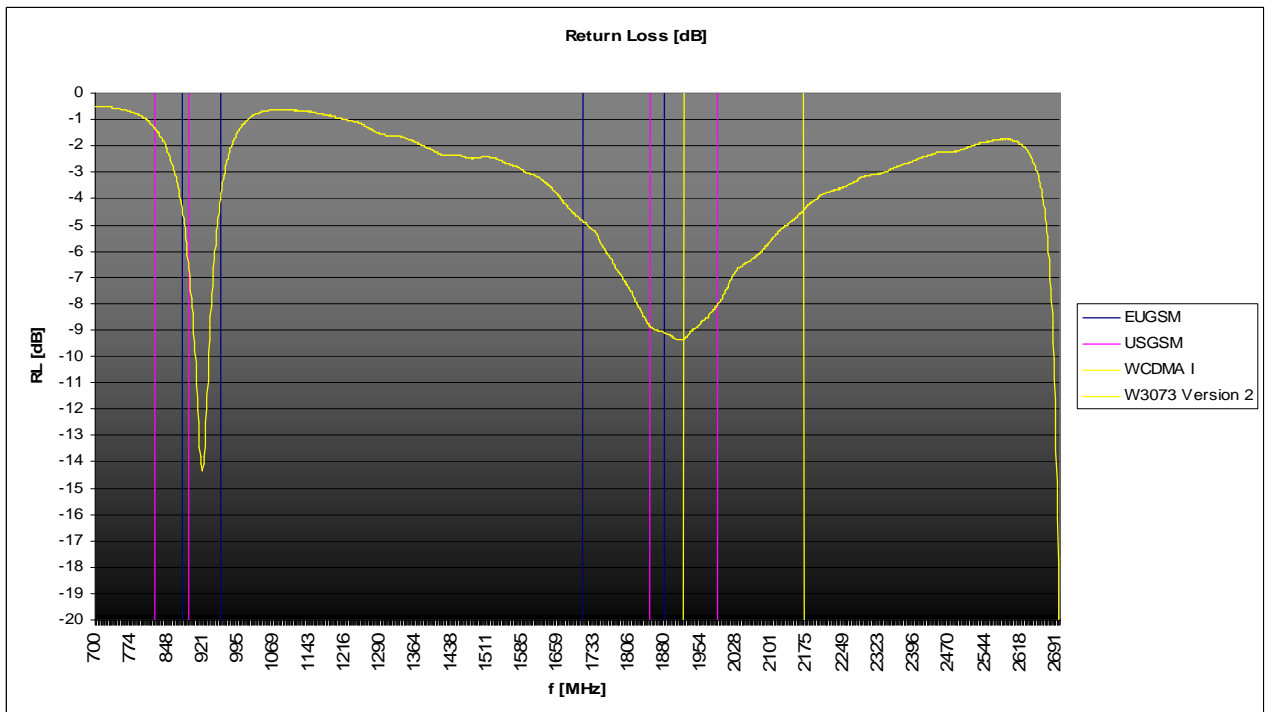



Version 1: Typical free Space Total Efficiencies [%]

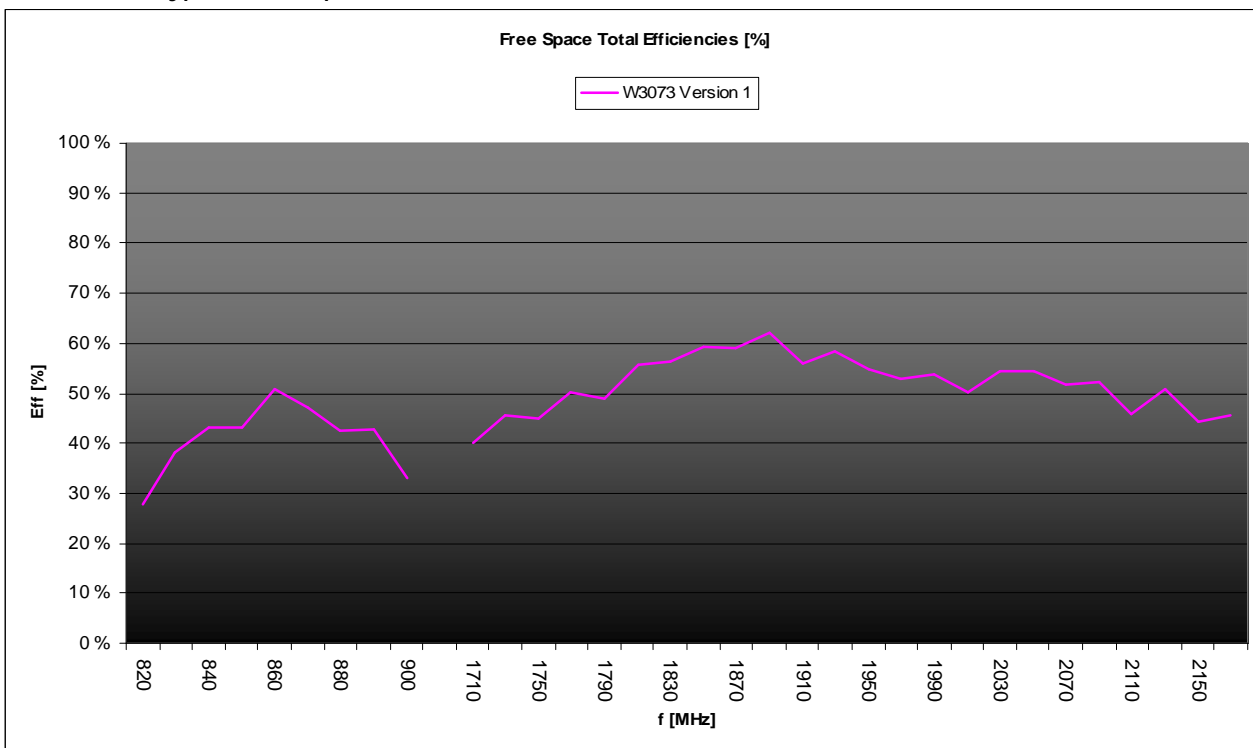

Version 2: Typical free Space Total Efficiencies [%]

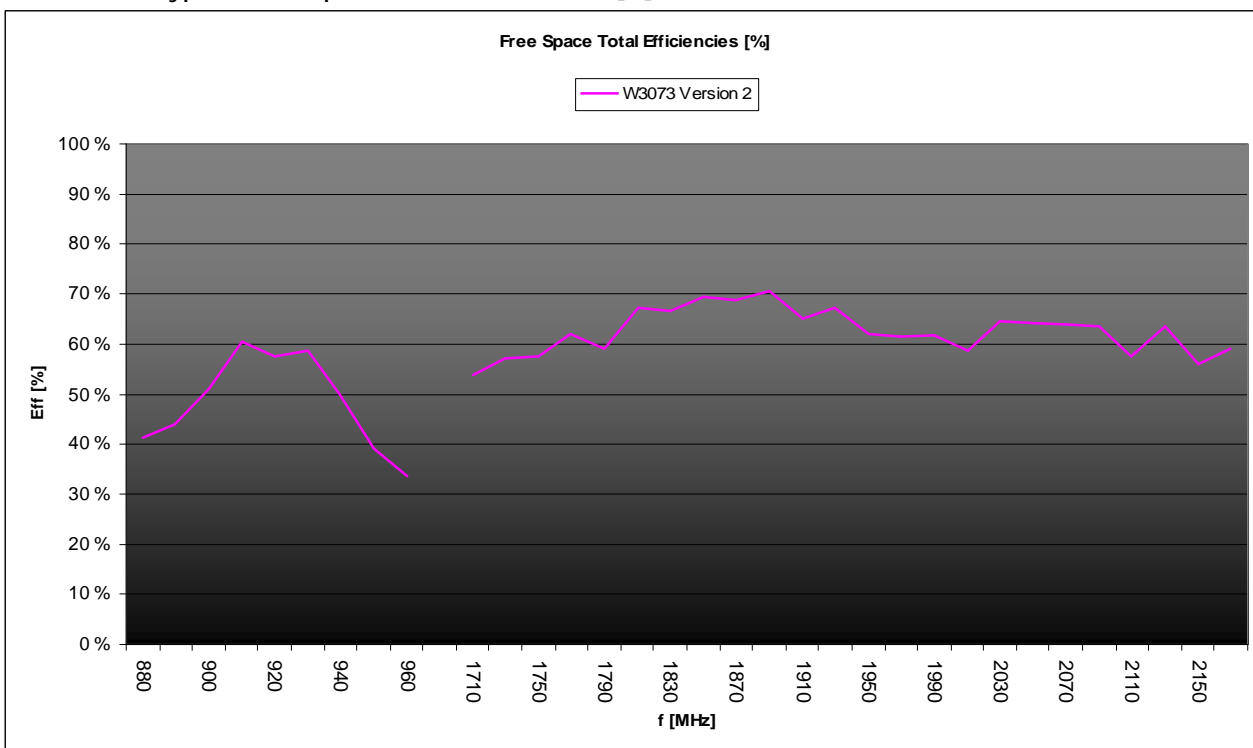

Version 1: Typical free Space Total Efficiencies [dB] and Maximum Gain [dBi]

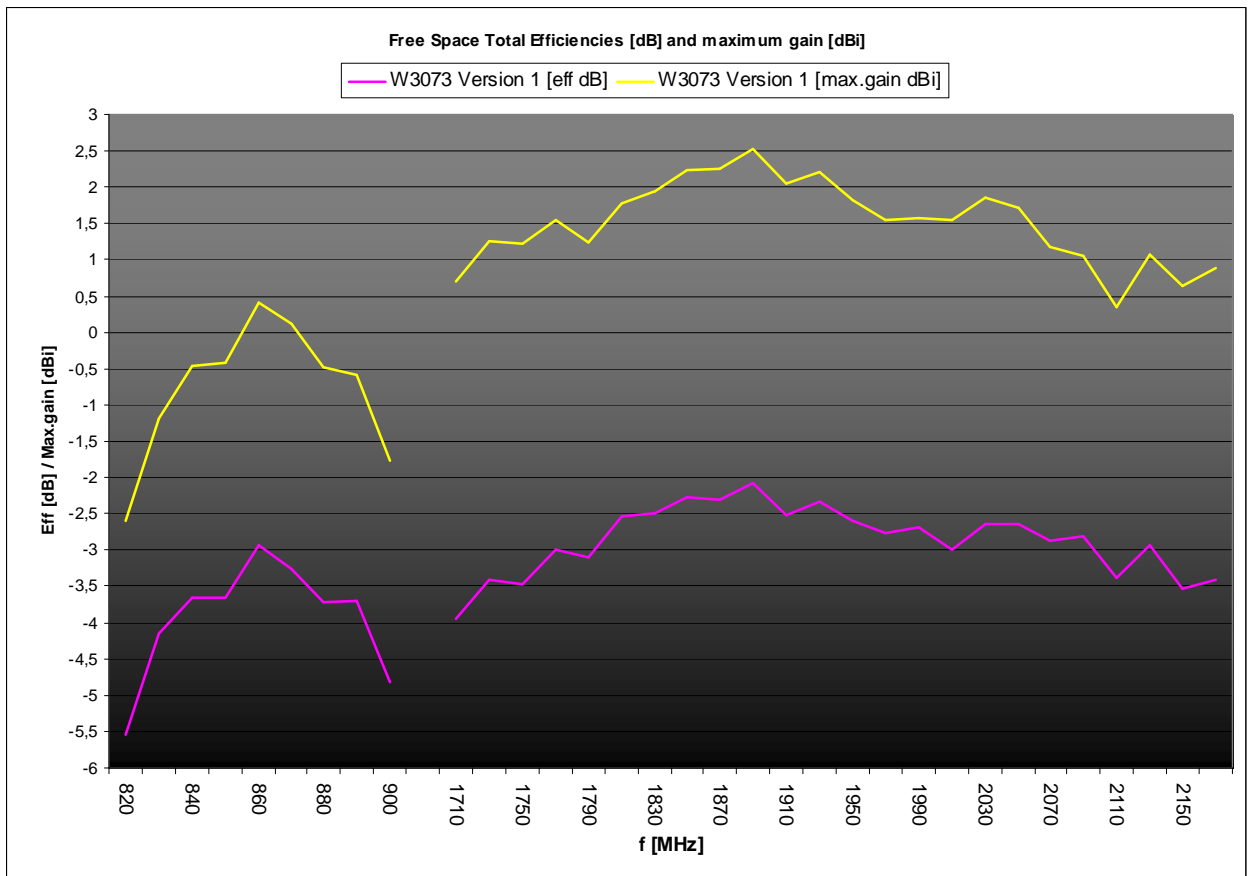

Version 2: Typical free Space Total Efficiencies [dB] and Maximum Gain [dBi]

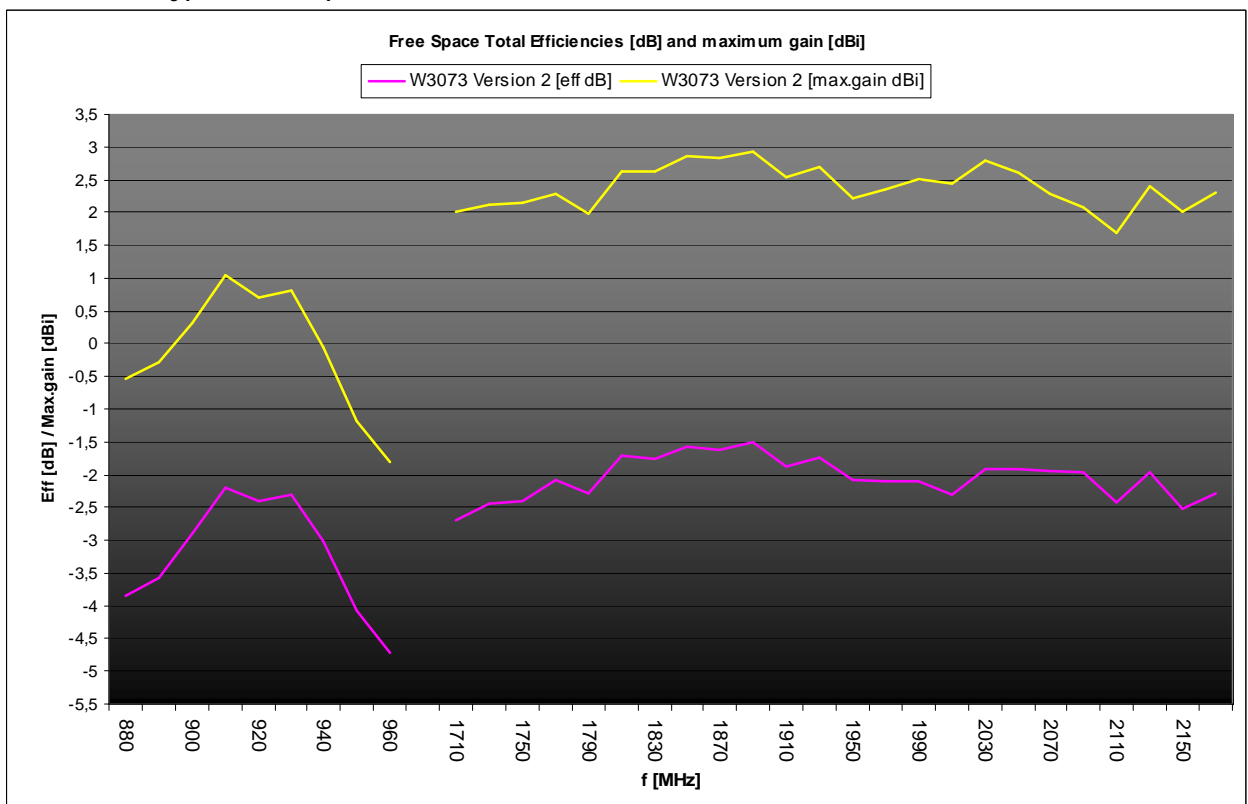

# Ceramic Chip Antenna

Measured with test board outline size 105 x 40mm. Ground cleared under antenna 40mm x 10mm.

## Version 1: Typical Free Space Radiation Patterns for GSM850 Band

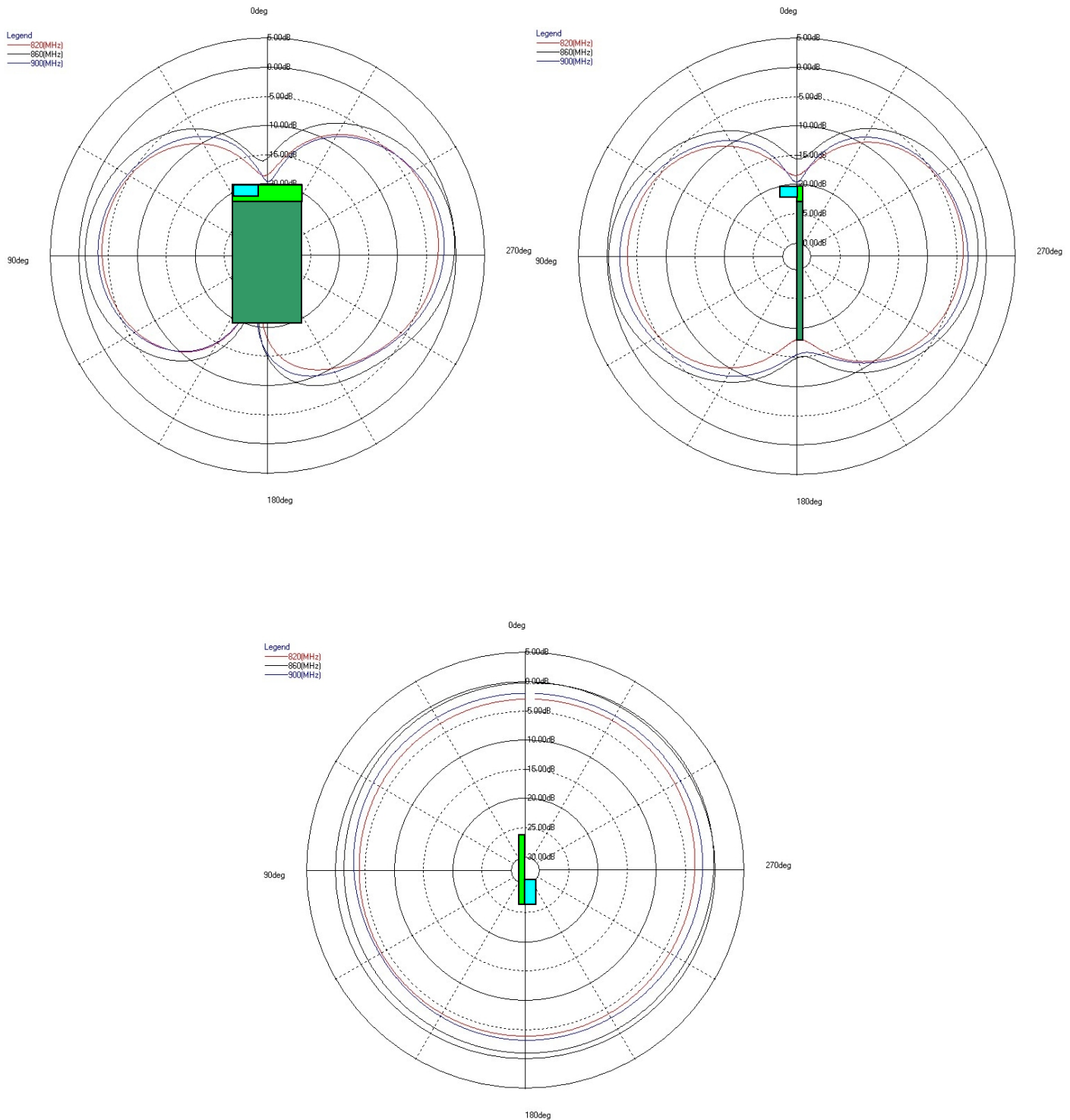

## Version 1: Typical Free Space Radiation Patterns for PCN1800, PCS1900 and WCDMA I Bands

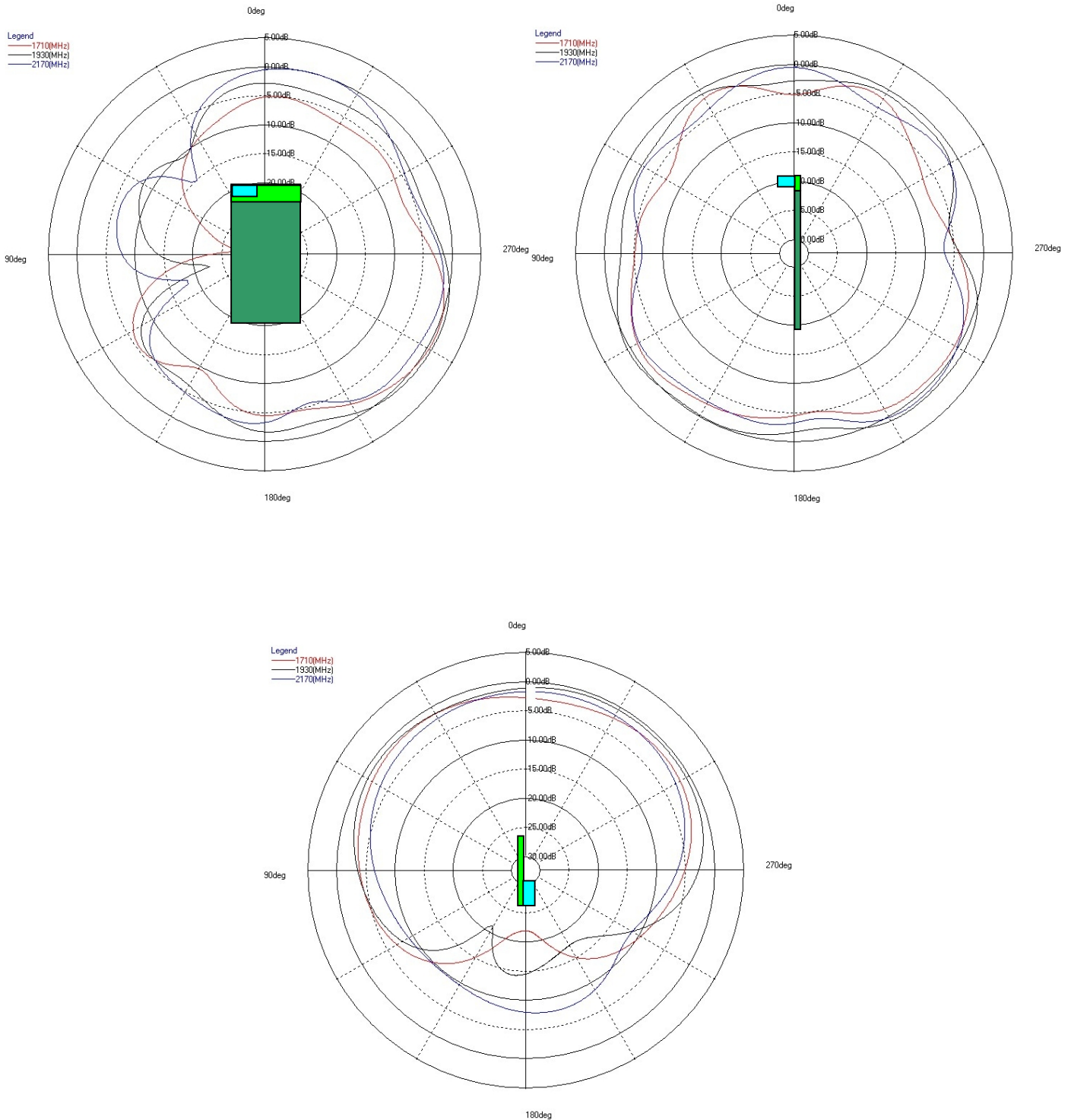

# Ceramic Chip Antenna

Measured with test board outline size 105 x 40mm. Ground cleared under antenna 40mm x 10mm.

## Version 2: Typical Free Space Radiation Patterns for EGSM900 Band

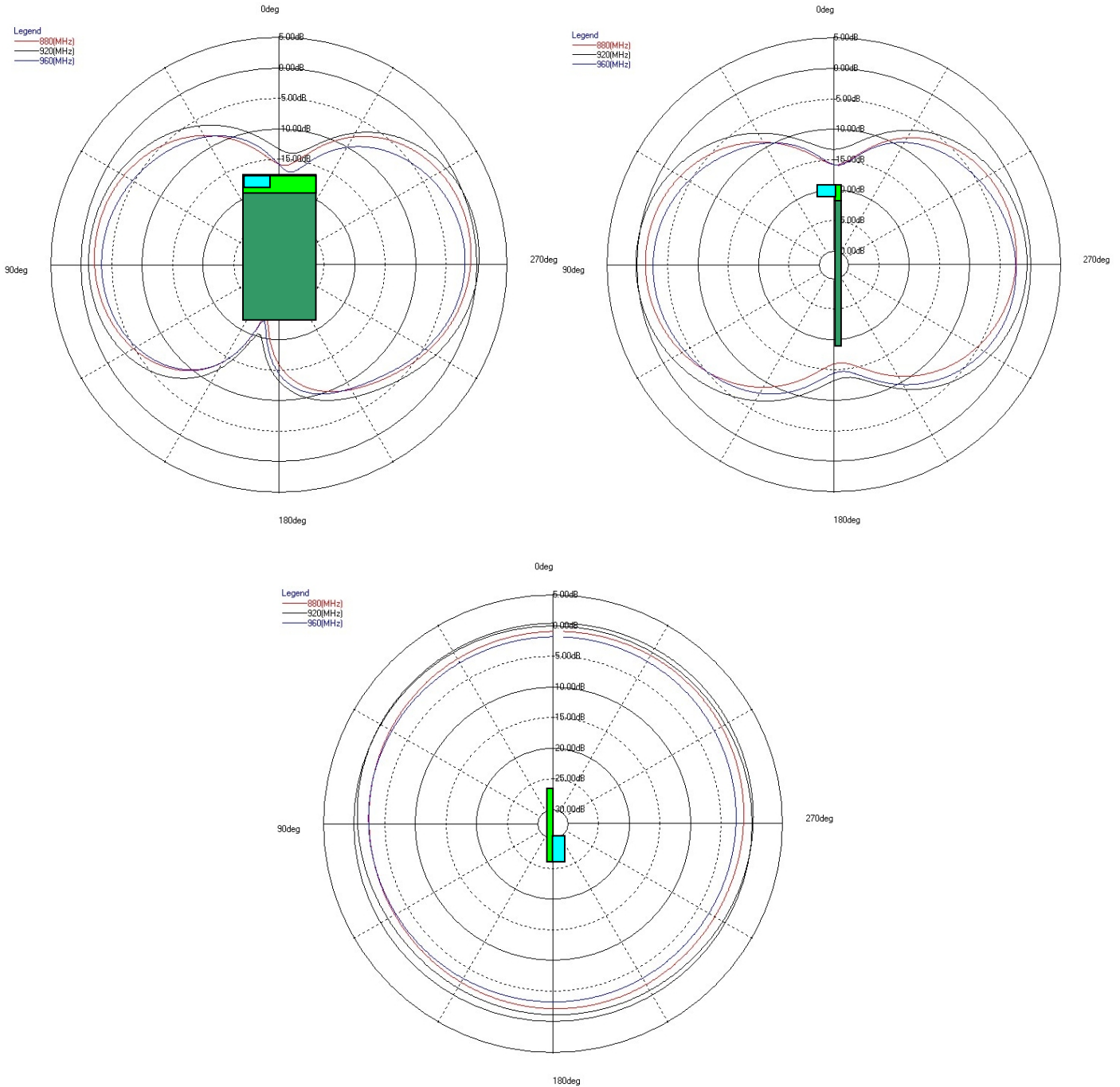

## Version 2: Typical Free Space Radiation Patterns for PCN1800, PCS1900 and WCDMA I Bands

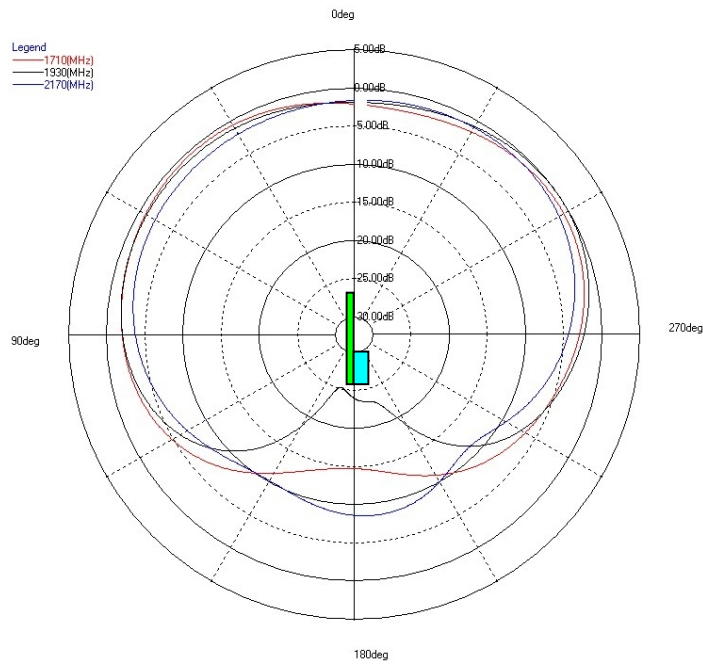
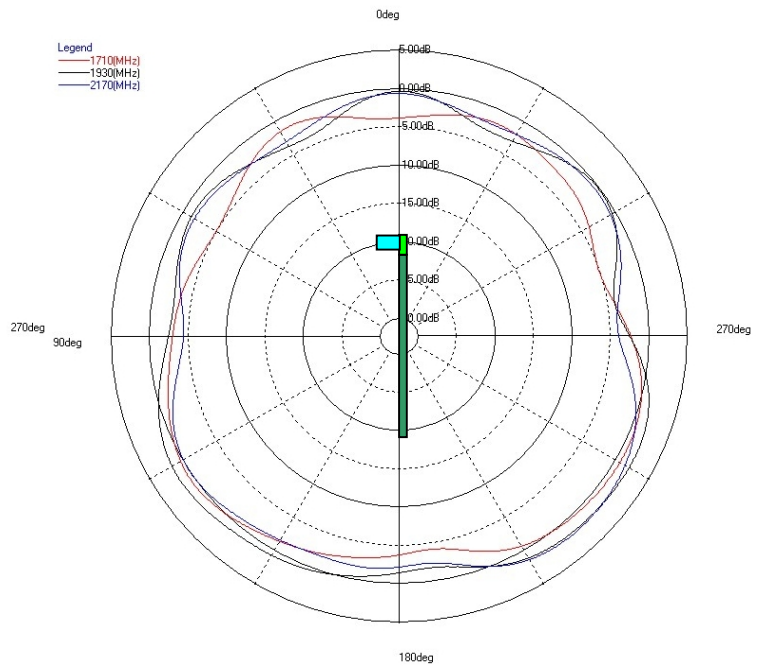
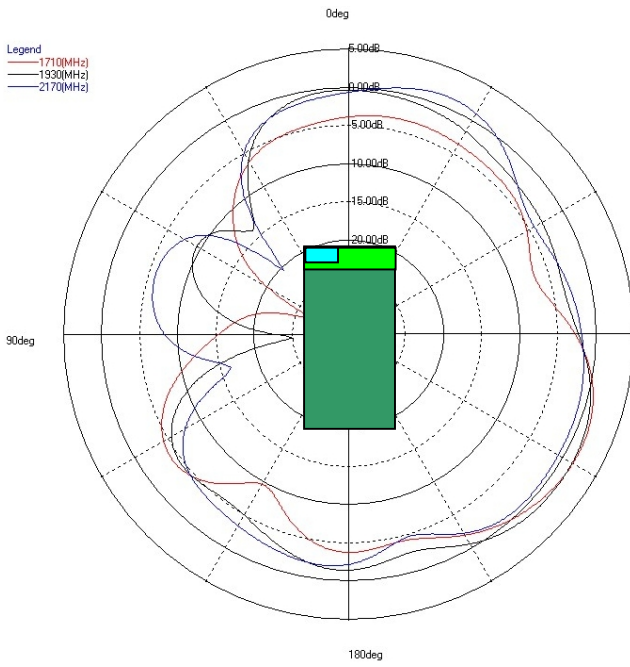

# Ceramic Chip Antenna

## Packing

### General

Tape and reel packing is used. Carrier tape, reel and box dimensions are presented in following pictures.

### Carrier Tape

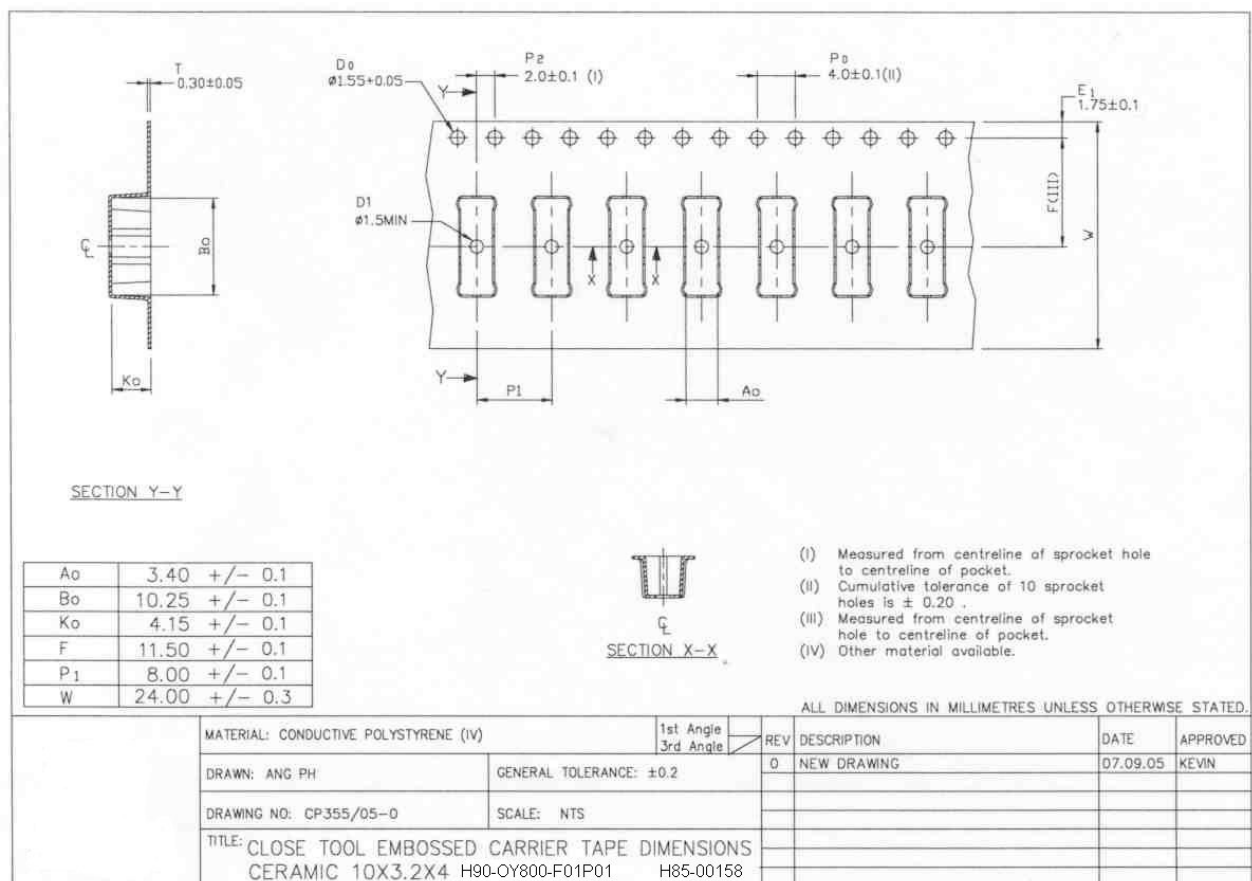

## Block Orientation

*Antenna soldering pads facing down to the bottom of the carrier tape.*

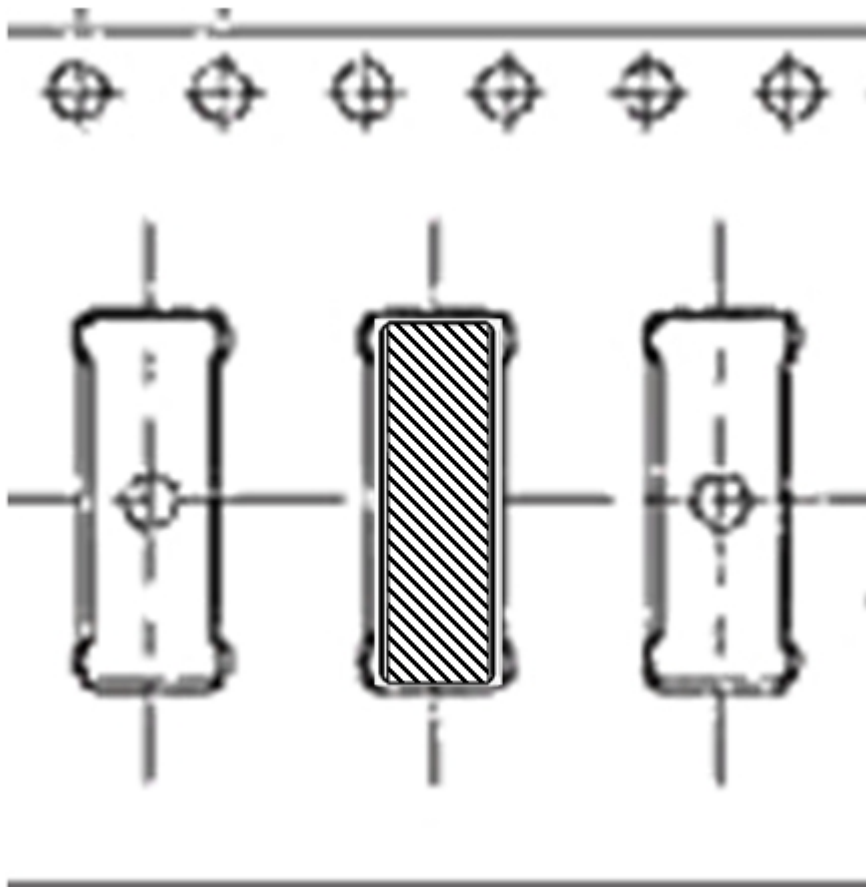



### Packing Form

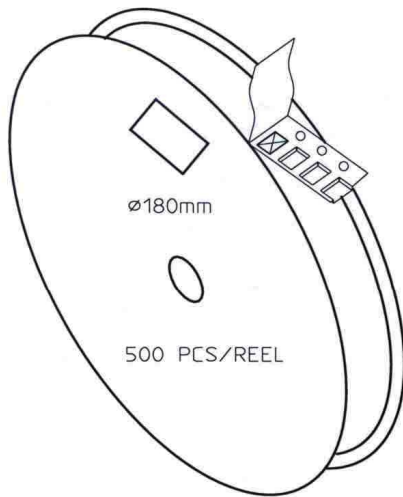

CARRIER TAPE H85-00158  
width=24,00 depth=4.15  
COVER TAPE H85-00159  
width=21.20

LENGTH OF TAPE:

- Leader section: min 350 mm before component section
- Trailer section: min 40 mm after component section.

Empty part cavities at leader and trailer section of the tape must be sealed with top cover tape.

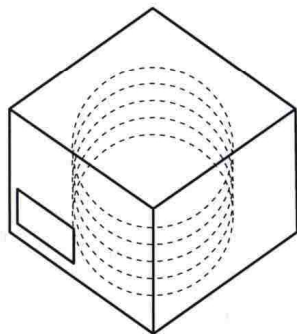

- BOX H85-00128 (182x182x125) 1 pcs
- LABEL 1 pcs/BOX
- REEL H85-00160 (D180, W28) 4 pcs
- REEL LABEL 1 pcs/REEL

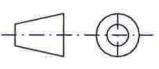
MATERIAL						
HANDLINGS						
		RATIO	DRWN	160107	PeHa	H
			DGNER			G
PRODUCT H90-OY800-F01P01			CHKD			F
			APPRD			E
			APPRD BY			D
						C
DENOMINATION PACKING FORM						B
						A
			VERSION			MOD/DATE/NAME

# Ceramic Chip Antenna

## Mechanical Outline

NOTE 4: Ag-metallization on hatched areas

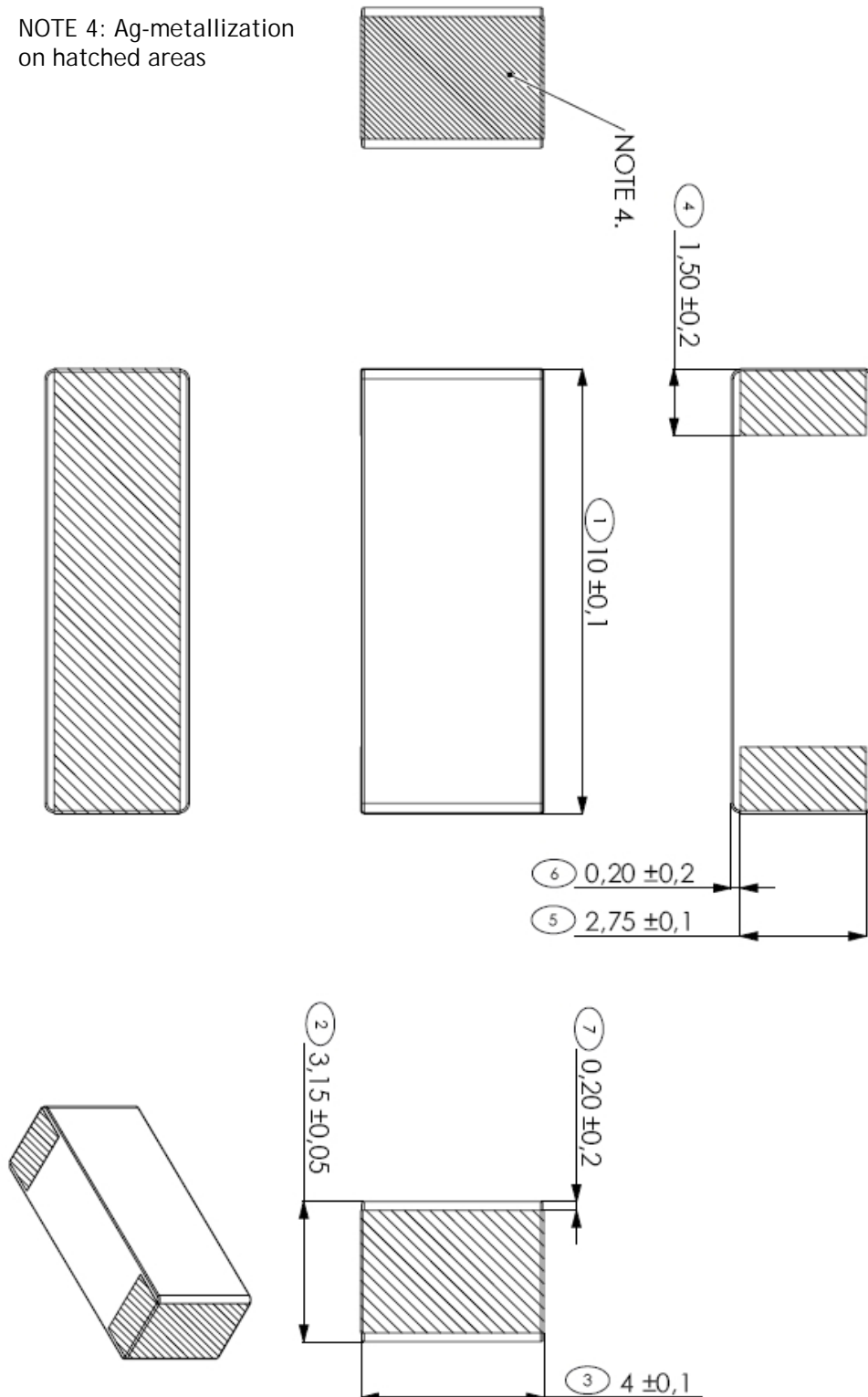

For More Information, please contact:

**Pulse Finland Oy**

Takatie 6

Fin-90440 Kempele

Finland

Tel. +358 207 935 500

Fax +358 207 935 501 (sales)

Domicile: Kempele

Business ID: 1933992-8

[firstname.lastname@pulseeng.com](mailto:firstname.lastname@pulseeng.com)

[www.pulseeng.com/antennas](http://www.pulseeng.com/antennas)

**Pulse World Wide Headquarters**

12220 World Trade Drive

San Diego, CA 92128

U.S.A

Tel. +1 858 674 8100

Fax +1 858 674 826

[www.pulseeng.com](http://www.pulseeng.com)

This is a "Preliminary" product application notes. Products mentioned on this application notes are in development and in the process of being qualified. These products are not fully released nor are they in production. Features, specifications and performance of products offered are subject to change without notice. Other brand and product names mentioned herein may be products and/or registered trademarks of their respective ones. For current info on this product, please contact the Pulse San Diego office.

© Copyright, 2006. Pulse Finland Oy. All rights reserved.