

THIS DRAWING IS UNCLASSIFIED  
 UNLESS INDICATED OTHERWISE  
 © 2005 BY TSC ELECTRONICS CORPORATION. ALL RIGHTS RESERVED.

**MECHANICAL:**

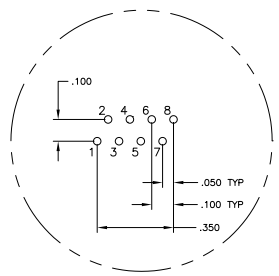

**Pin Designations**

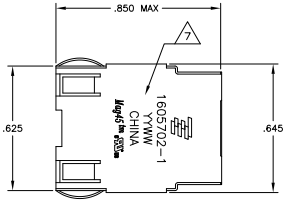
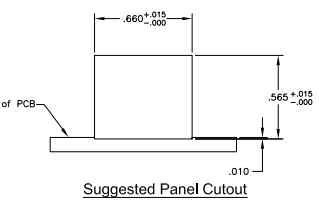
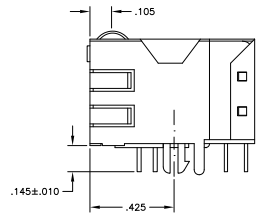
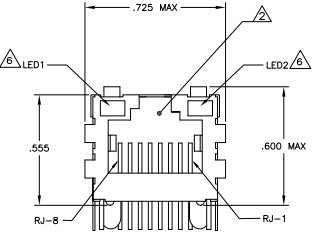

**Suggested Panel Cutout**

**706 SERIES MAGNETIC CIRCUIT**

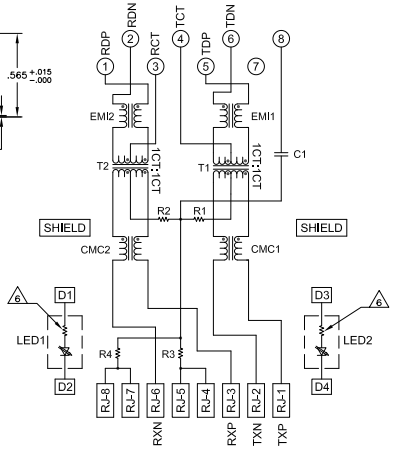

C1 = 1000 pF, 2KV DECOUPLING CAPACITOR.  
 R1-R4 = 75 OHMS, 1/16 W, 5% RESISTORS.

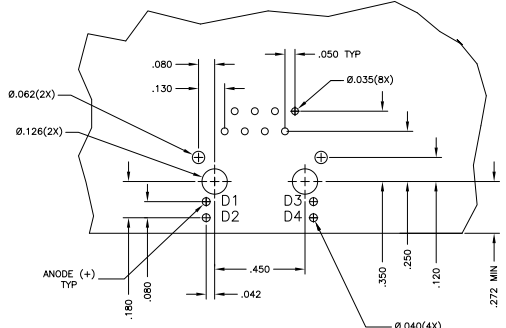

**Suggested PCB Layout (Component Side)**

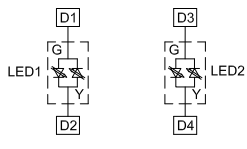

**LED CONFIGURATION FOR 5-1605702-6 ONLY**

REV	DATE	BY	CHKD	REVISIONS
AA	22			
C				REV PER ECO-08-011039
CT				REVISED PER ECO-10-000443

**MATERIALS:**  
 HOUSING - THERMOPLASTIC PET POLYESTER FLAMMABILITY RATING UL 94V-0, SHIELD - .010" THICK, C26800 BRASS PREPLATED WITH 80-150µinch SEMI-BRIGHT NICKEL, POST-DIPPED WITH 100µinch MIN TIN-LEAD.  
 MOD JACK CONTACTS - .0157" x .018" THICK, PHOSPHOR BRONZE, 50µinch MIN OVERALL NICKEL UNDERPLATE, WITH SELECT 50µinch MIN HARD GOLD FINISH PLATE. SOLDER TAILS WITH 50µinch MIN TIN-LEAD FINISH PLATE.  
 LIGHT EMITTING DIODE(LED) - DIFFUSED EPOXY LENS, .020" x .020" CARBON STEEL WIREFRAME LEADS PREPLATED WITH 90µinch SILVER OVER 40µinch NICKEL UNDERPLATE OVER 80µinch COPPER UNDERPLATE, POST-PLATED WITH 300µinch THICK TIN-LEAD.

**RJ45 JACK CAVITY CONFORMS TO FCC RULES AND REGULATIONS PART 68, SUB PART F.**

**MAGNETICS:**  
 -IMPEDANCE: 100 OHMS  
 -TRANSMIT OPEN CIRCUIT INDUCTANCE (OCL): 350µH (MIN) @100KHZ, 0.1VRMS WITH 8 mA DC BIAS  
 -RISE TIME: 2.5 NANO-SECONDS FROM 10 TO 90 PERCENT.  
 -TURNS RATIO (ICHP: CABLE): TX: 1:1, RX: 1:1  
**PERFORMANCE:**  
 -TRANSMIT RJ1 & 2  
 -RECEIVE RJ3 & 6.

FREQUENCY	INSERTION LOSS	RETURN LOSS	CROSSTALK ATTENUATION	COMMON MODE REJECTION RATIO	
			TX	RX	
100 MHz-999 MHz	1.0 dB(MAX)	18.0 dB(MIN)	43.0 dB(MIN)	46.0 dB(MIN)	35.0 dB(MIN)
1.0 MHz-15.0 MHz	0.3 dB(MAX)	18.0 dB(MIN)	43.0 dB(MIN)	46.0 dB(MIN)	35.0 dB(MIN)
15.1 MHz-60.0 MHz	0.6 dB(MAX)	18.0 dB(MIN)	43.0 dB(MIN)	46.0 dB(MIN)	35.0 dB(MIN)
60.1 MHz-80.0 MHz	1.1 dB(MAX)	15.0 dB(MIN)	38.0 dB(MIN)	42.0 dB(MIN)	33.0 dB(MIN)
80.1 MHz-100.0 MHz	1.1 dB(MAX)	12.0 dB(MIN)	36.0 dB(MIN)	42.0 dB(MIN)	33.0 dB(MIN)

**HIPOT (ISOLATION VOLTAGE):**  
 -1500 VRMS (0.5 mA CUTOFF CURRENT) FOR 60 SECONDS DURATION WITHOUT DECOUPLING CAPACITOR.  
 -2250 VDC (1 mA CUTOFF CURRENT) FOR 60 SECONDS DURATION WITH DECOUPLING CAPACITOR.  
 -ALL BRIDGED ON EITHER SIDE OF MAGNETICS PACKAGE FOR RJ-45 CONTACTS. OPERATING TEMPERATURE: FROM 0° - +70°C.

**ALL DIMENSIONS NOMINAL UNLESS OTHERWISE NOTED.**

**INDICATED CONNECTIONS ARE FOR NIC CONFIGURATION. THE MAGNETICS ARE SYMMETRICAL, AND THEREFORE DOES SUPPORT AUTO-HOT/PODK.**

**THE 250 OHM RESISTOR IS OPTIONAL, PLEASE SEE CHART FOR PRESENCE OR ABSENCE OF LED RESISTORS.**  
 IF LEDS WITHOUT 250 OHM RESISTOR, LEDS ARE DRIVEN WITH CONSTANT CURRENT AT APPROX 20 mA  
 LED COLOR: DOMINANT WAVELENGTH (λD): GREEN 568 nm TYP @ IF=20 mA  
 FORWARD VOLTAGE (VF): GREEN 2.2V TYP @ IF=20 mA  
 DOMINANT WAVELENGTH (λD): YELLOW 588 nm TYP @ IF=20 mA  
 FORWARD VOLTAGE (VF): YELLOW 2.1V TYP @ IF=20 mA  
 IF LEDS WITH BUILT-IN RESISTOR, LEDS ARE DRIVEN WITH 5V VOLTAGE AND THE MAX OPERATING CURRENT IS 20mA.  
 LED COLOR: DOMINANT WAVELENGTH (λD): GREEN 568 nm TYP @ VF=5V  
 FORWARD CURRENT (IF): GREEN 12mA TYP @ VF=5V  
 DOMINANT WAVELENGTH (λD): YELLOW 588 nm TYP @ VF=5V  
 FORWARD CURRENT (IF): YELLOW 13mA TYP @ VF=5V

**TYCO ELECTRONICS LOGO, PART NUMBER, DATE CODE, COUNTRY OF ORIGIN AND AGENCY APPROVAL MARKING IN APPROXIMATE LOCATION SHOWN.**

**THESE PARTS ARE RECOMMENDED FOR WAVE SOLDERING PROCESS, PEAK WAVE SOLDERING TEMPERATURE IS 265°C MAX, 10 SEC MAX.**

**OBsolete PARTS: OBSOLETE CIS STREAMLINING PER D.RENAUD/D.SINISI**

YES	YES	GREEN	GREEN	6-1605702-1
NO	YES	GREEN	GREEN	5-1605702-7
NO	YES	GREEN/YELLOW	GREEN/YELLOW	5-1605702-6
YES	YES	GREEN	YELLOW	5-1605702-1
YES	NO	GREEN	GREEN	4-1605702-1

THIS DRAWING IS A CONTROLLED DOCUMENT.				REV	DATE	BY	CHKD	REVISIONS
DESIGNED	DESIGNED	DESIGNED	DESIGNED	1				
1X1	MAC45(TM)	MODULAR JACK,	7N7 SCHEMATIC, 706 SERIES CIRCUIT, SHIELDED,					
108-2100			OPTIONAL DECOUPLING CAPACITOR, WITH LEDS					
DATE	DATE	DATE	DATE	1	00779	1605702		
CUSTOMER DRAWING								