

IHM-A Modul  
IHM-A module

**Vorläufige Daten / Preliminary Data**

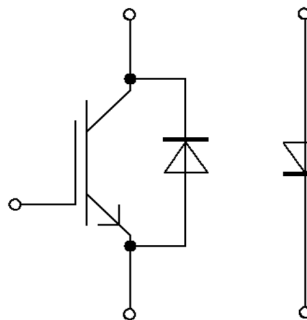

Typical Appearance



$V_{CES} = 3300V$   
 $I_{C\ nom} = 800A / I_{CRM} = 1600A$

**Typische Anwendungen**

- Chopper-Anwendungen
- Traktionsumrichter

**Typical Applications**

- Chopper Applications
- Traction Drives

**Mechanische Eigenschaften**

- AlSiC Bodenplatte für erhöhte thermische Lastwechselfestigkeit

**Mechanical Features**

- AlSiC Base Plate for increased Thermal Cycling Capability

**Module Label Code**

Barcode Code 128



DMX - Code



**Content of the Code**

Content of the Code	Digit
Module Serial Number	1 - 5
Module Material Number	6 - 11
Production Order Number	12 - 19
Datecode (Production Year)	20 - 21
Datecode (Production Week)	22 - 23

prepared by: SB	date of publication: 2013-11-25	
approved by: DTS	revision: 2.3	UL approved (E83335)



**Vorläufige Daten  
Preliminary Data**

**IGBT, Brems-Chopper / IGBT, Brake-Chopper  
Höchstzulässige Werte / Maximum Rated Values**

Kollektor-Emitter-Sperrspannung Collector-emitter voltage	$T_{vj} = 25^{\circ}\text{C}$ $T_{vj} = -25^{\circ}\text{C}$	$V_{CES}$	3300 3300	V
Kollektor-Dauergleichstrom Continuous DC collector current	$T_C = 80^{\circ}\text{C}, T_{vj\text{max}} = 150^{\circ}\text{C}$ $T_C = 25^{\circ}\text{C}, T_{vj\text{max}} = 150^{\circ}\text{C}$	$I_{C\text{nom}}$ $I_C$	800 1300	A A
Periodischer Kollektor-Spitzenstrom Repetitive peak collector current	$t_P = 1\text{ ms}$	$I_{CRM}$	1600	A
Gesamt-Verlustleistung Total power dissipation	$T_C = 25^{\circ}\text{C}, T_{vj\text{max}} = 150^{\circ}\text{C}$	$P_{tot}$	9,60	kW
Gate-Emitter-Spitzenspannung Gate-emitter peak voltage		$V_{GES}$	+/-20	V

**Charakteristische Werte / Characteristic Values**

			min.	typ.	max.		
Kollektor-Emitter-Sättigungsspannung Collector-emitter saturation voltage	$I_C = 800\text{ A}, V_{GE} = 15\text{ V}$ $I_C = 800\text{ A}, V_{GE} = 15\text{ V}$	$T_{vj} = 25^{\circ}\text{C}$ $T_{vj} = 125^{\circ}\text{C}$	$V_{CE\text{sat}}$	3,40 4,30	4,25 5,00	V V	
Gate-Schwellenspannung Gate threshold voltage	$I_C = 80,0\text{ mA}, V_{CE} = V_{GE}, T_{vj} = 25^{\circ}\text{C}$		$V_{G\text{eth}}$	4,2	5,1	6,0	V
Gateladung Gate charge	$V_{GE} = -15\text{ V} \dots +15\text{ V}, V_{CE} = 1800\text{ V}$		$Q_G$	15,0			$\mu\text{C}$
Interner Gatewiderstand Internal gate resistor	$T_{vj} = 25^{\circ}\text{C}$		$R_{G\text{int}}$	0,63			$\Omega$
Eingangskapazität Input capacitance	$f = 1\text{ MHz}, T_{vj} = 25^{\circ}\text{C}, V_{CE} = 25\text{ V}, V_{GE} = 0\text{ V}$		$C_{ies}$	100			nF
Rückwirkungskapazität Reverse transfer capacitance	$f = 1\text{ MHz}, T_{vj} = 25^{\circ}\text{C}, V_{CE} = 25\text{ V}, V_{GE} = 0\text{ V}$		$C_{res}$	5,40			nF
Kollektor-Emitter-Reststrom Collector-emitter cut-off current	$V_{CE} = 3300\text{ V}, V_{GE} = 0\text{ V}, T_{vj} = 25^{\circ}\text{C}$		$I_{CES}$		5,0		mA
Gate-Emitter-Reststrom Gate-emitter leakage current	$V_{CE} = 0\text{ V}, V_{GE} = 20\text{ V}, T_{vj} = 25^{\circ}\text{C}$		$I_{GES}$		400		nA
Einschaltverzögerungszeit, induktive Last Turn-on delay time, inductive load	$I_C = 800\text{ A}, V_{CE} = 1800\text{ V}$ $V_{GE} = \pm 15\text{ V}$ $R_{G\text{on}} = 1,4\ \Omega, C_{GE} = 150\text{ nF}$	$T_{vj} = 25^{\circ}\text{C}$ $T_{vj} = 125^{\circ}\text{C}$	$t_{d\text{on}}$	0,28 0,28			$\mu\text{s}$ $\mu\text{s}$
Anstiegszeit, induktive Last Rise time, inductive load	$I_C = 800\text{ A}, V_{CE} = 1800\text{ V}$ $V_{GE} = \pm 15\text{ V}$ $R_{G\text{on}} = 1,4\ \Omega, C_{GE} = 150\text{ nF}$	$T_{vj} = 25^{\circ}\text{C}$ $T_{vj} = 125^{\circ}\text{C}$	$t_r$	0,18 0,20			$\mu\text{s}$ $\mu\text{s}$
Abschaltverzögerungszeit, induktive Last Turn-off delay time, inductive load	$I_C = 800\text{ A}, V_{CE} = 1800\text{ V}$ $V_{GE} = \pm 15\text{ V}$ $R_{G\text{off}} = 1,8\ \Omega, C_{GE} = 150\text{ nF}$	$T_{vj} = 25^{\circ}\text{C}$ $T_{vj} = 125^{\circ}\text{C}$	$t_{d\text{off}}$	1,55 1,70			$\mu\text{s}$ $\mu\text{s}$
Fallzeit, induktive Last Fall time, inductive load	$I_C = 800\text{ A}, V_{CE} = 1800\text{ V}$ $V_{GE} = \pm 15\text{ V}$ $R_{G\text{off}} = 1,8\ \Omega, C_{GE} = 150\text{ nF}$	$T_{vj} = 25^{\circ}\text{C}$ $T_{vj} = 125^{\circ}\text{C}$	$t_f$	0,20 0,20			$\mu\text{s}$ $\mu\text{s}$
Einschaltverlustenergie pro Puls Turn-on energy loss per pulse	$I_C = 800\text{ A}, V_{CE} = 1800\text{ V}, L_S = 40\text{ nH}$ $V_{GE} = \pm 15\text{ V}$ $R_{G\text{on}} = 1,4\ \Omega, C_{GE} = 150\text{ nF}$	$T_{vj} = 25^{\circ}\text{C}$ $T_{vj} = 125^{\circ}\text{C}$	$E_{on}$	930 1450			mJ mJ
Abschaltverlustenergie pro Puls Turn-off energy loss per pulse	$I_C = 800\text{ A}, V_{CE} = 1800\text{ V}, L_S = 40\text{ nH}$ $V_{GE} = \pm 15\text{ V}$ $R_{G\text{off}} = 1,8\ \Omega, C_{GE} = 150\text{ nF}$	$T_{vj} = 25^{\circ}\text{C}$ $T_{vj} = 125^{\circ}\text{C}$	$E_{off}$	870 1000			mJ mJ
Kurzschlußverhalten SC data	$V_{GE} \leq 15\text{ V}, V_{CC} = 2500\text{ V}$ $V_{CE\text{max}} = V_{CES} - L_{SCE} \cdot di/dt$	$t_P \leq 10\ \mu\text{s}, T_{vj} = 125^{\circ}\text{C}$	$I_{SC}$	4000			A
Wärmewiderstand, Chip bis Gehäuse Thermal resistance, junction to case	pro IGBT / per IGBT		$R_{thJC}$		13,0		K/kW
Wärmewiderstand, Gehäuse bis Kühlkörper Thermal resistance, case to heatsink	pro IGBT / per IGBT $\lambda_{\text{Paste}} = 1\text{ W}/(\text{m}\cdot\text{K}) / \lambda_{\text{grease}} = 1\text{ W}/(\text{m}\cdot\text{K})$		$R_{thCH}$	8,00			K/kW
Temperatur im Schaltbetrieb Temperature under switching conditions			$T_{vj\text{op}}$	-40	125		$^{\circ}\text{C}$

prepared by: SB	date of publication: 2013-11-25
approved by: DTS	revision: 2.3



**Vorläufige Daten  
Preliminary Data**

**Diode, Brems-Chopper / Diode, Brake-Chopper  
Höchstzulässige Werte / Maximum Rated Values**

Periodische Spitzensperrspannung Repetitive peak reverse voltage	$T_{vj} = 25^{\circ}\text{C}$ $T_{vj} = -25^{\circ}\text{C}$	$V_{RRM}$	3300 3300	V
Dauergleichstrom Continuous DC forward current		$I_F$	800	A
Periodischer Spitzenstrom Repetitive peak forward current	$t_P = 1 \text{ ms}$	$I_{FRM}$	1600	A
Grenzlastintegral $I^2t$ - value	$V_R = 0 \text{ V}, t_P = 10 \text{ ms}, T_{vj} = 125^{\circ}\text{C}$	$I^2t$	220	$\text{kA}^2\text{s}$
Spitzenverlustleistung Maximum power dissipation	$T_{vj} = 125^{\circ}\text{C}$	$P_{RQM}$	1600	kW
Mindesteinschaltdauer Minimum turn-on time		$t_{on \text{ min}}$	10,0	$\mu\text{s}$

**Charakteristische Werte / Characteristic Values**

			min.	typ.	max.	
Durchlassspannung Forward voltage	$I_F = 800 \text{ A}, V_{GE} = 0 \text{ V}$	$T_{vj} = 25^{\circ}\text{C}$	$V_F$	2,80	3,50	V
	$I_F = 800 \text{ A}, V_{GE} = 0 \text{ V}$	$T_{vj} = 125^{\circ}\text{C}$				
Rückstromspitze Peak reverse recovery current	$I_F = 800 \text{ A}, -di_F/dt = 4500 \text{ A}/\mu\text{s} (T_{vj}=125^{\circ}\text{C})$ $V_R = 1800 \text{ V}$ $V_{GE} = -15 \text{ V}$	$T_{vj} = 25^{\circ}\text{C}$	$I_{RM}$	1100	1300	A A
		$T_{vj} = 125^{\circ}\text{C}$				
Sperrverzögerungsladung Recovered charge	$I_F = 800 \text{ A}, -di_F/dt = 4500 \text{ A}/\mu\text{s} (T_{vj}=125^{\circ}\text{C})$ $V_R = 1800 \text{ V}$ $V_{GE} = -15 \text{ V}$	$T_{vj} = 25^{\circ}\text{C}$	$Q_r$	500	900	$\mu\text{C}$ $\mu\text{C}$
		$T_{vj} = 125^{\circ}\text{C}$				
Abschaltenergie pro Puls Reverse recovery energy	$I_F = 800 \text{ A}, -di_F/dt = 4500 \text{ A}/\mu\text{s} (T_{vj}=125^{\circ}\text{C})$ $V_R = 1800 \text{ V}$ $V_{GE} = -15 \text{ V}$	$T_{vj} = 25^{\circ}\text{C}$	$E_{rec}$	490	1150	mJ mJ
		$T_{vj} = 125^{\circ}\text{C}$				
Wärmewiderstand, Chip bis Gehäuse Thermal resistance, junction to case	pro Diode / per diode		$R_{thJC}$		26,0	K/kW
Wärmewiderstand, Gehäuse bis Kühlkörper Thermal resistance, case to heatsink	pro Diode / per diode $\lambda_{\text{Paste}} = 1 \text{ W}/(\text{m}\cdot\text{K})$ / $\lambda_{\text{grease}} = 1 \text{ W}/(\text{m}\cdot\text{K})$		$R_{thCH}$	16,0		K/kW
Temperatur im Schaltbetrieb Temperature under switching conditions			$T_{vj \text{ op}}$	-40	125	$^{\circ}\text{C}$

prepared by: SB	date of publication: 2013-11-25
approved by: DTS	revision: 2.3

Vorläufige Daten  
Preliminary Data

## Diode, Revers / Diode, Reverse

## Höchstzulässige Werte / Maximum Rated Values

Periodische Spitzensperrspannung Repetitive peak reverse voltage	$T_{vj} = 25^{\circ}\text{C}$ $T_{vj} = -25^{\circ}\text{C}$	$V_{RRM}$	3300 3300	V
Dauergleichstrom Continuous DC forward current		$I_F$	800	A
Periodischer Spitzenstrom Repetitive peak forward current	$t_P = 1 \text{ ms}$	$I_{FRM}$	1600	A
Grenzlastintegral $I^2t$ - value	$V_R = 0 \text{ V}$ , $t_P = 10 \text{ ms}$ , $T_{vj} = 125^{\circ}\text{C}$	$I^2t$	220	$\text{kA}^2\text{s}$
Spitzenverlustleistung Maximum power dissipation	$T_{vj} = 125^{\circ}\text{C}$	$P_{RQM}$	1600	kW
Mindesteinschaltdauer Minimum turn-on time		$t_{on \text{ min}}$	10,0	$\mu\text{s}$

## Charakteristische Werte / Characteristic Values

				min.	typ.	max.	
Durchlassspannung Forward voltage	$I_F = 800 \text{ A}$ , $V_{GE} = 0 \text{ V}$	$T_{vj} = 25^{\circ}\text{C}$	$V_F$		2,80	3,50	V
	$I_F = 800 \text{ A}$ , $V_{GE} = 0 \text{ V}$	$T_{vj} = 125^{\circ}\text{C}$			2,80	3,50	V
Rückstromspitze Peak reverse recovery current	$I_F = 800 \text{ A}$ , $-di_F/dt = 4500 \text{ A}/\mu\text{s}$ ( $T_{vj}=125^{\circ}\text{C}$ ) $V_R = 1800 \text{ V}$	$T_{vj} = 25^{\circ}\text{C}$	$I_{RM}$		1100		A
		$T_{vj} = 125^{\circ}\text{C}$			1300		A
Sperrverzögerungsladung Recovered charge	$I_F = 800 \text{ A}$ , $-di_F/dt = 4500 \text{ A}/\mu\text{s}$ ( $T_{vj}=125^{\circ}\text{C}$ ) $V_R = 1800 \text{ V}$	$T_{vj} = 25^{\circ}\text{C}$	$Q_r$		500		$\mu\text{C}$
		$T_{vj} = 125^{\circ}\text{C}$			900		$\mu\text{C}$
Abschaltenergie pro Puls Reverse recovery energy	$I_F = 800 \text{ A}$ , $-di_F/dt = 4500 \text{ A}/\mu\text{s}$ ( $T_{vj}=125^{\circ}\text{C}$ ) $V_R = 1800 \text{ V}$	$T_{vj} = 25^{\circ}\text{C}$	$E_{rec}$		490		mJ
		$T_{vj} = 125^{\circ}\text{C}$			1150		mJ
Wärmewiderstand, Chip bis Gehäuse Thermal resistance, junction to case	pro Diode / per diode		$R_{thJC}$			26,0	K/kW
Wärmewiderstand, Gehäuse bis Kühlkörper Thermal resistance, case to heatsink	pro Diode / per diode $\lambda_{\text{Paste}} = 1 \text{ W}/(\text{m}\cdot\text{K})$ / $\lambda_{\text{grease}} = 1 \text{ W}/(\text{m}\cdot\text{K})$		$R_{thCH}$		16,0		K/kW
Temperatur im Schaltbetrieb Temperature under switching conditions			$T_{vj \text{ op}}$	-40		125	$^{\circ}\text{C}$

prepared by: SB

date of publication: 2013-11-25

approved by: DTS

revision: 2.3



**Vorläufige Daten  
Preliminary Data**

**Modul / Module**

Isolations-Prüfspannung Isolation test voltage	RMS, f = 50 Hz, t = 1 min.	V <sub>ISOL</sub>	6,0		kV
Teilentladungs-Aussetzspannung Partial discharge extinction voltage	RMS, f = 50 Hz, Q <sub>PD</sub> ≤ 10 pC (acc. to IEC 1287)	V <sub>ISOL</sub>	2,6		kV
Kollektor-Emitter-Gleichsperrspannung DC stability	T <sub>vj</sub> = 25°C, 100 fit	V <sub>CE D</sub>	1800		V
Material Modulgrundplatte Material of module baseplate			AISIC		
Innere Isolation Internal isolation	Basisisolierung (Schutzklasse 1, EN61140) basic insulation (class 1, IEC 61140)		AIN		
Kriechstrecke Creepage distance	Kontakt - Kühlkörper / terminal to heatsink Kontakt - Kontakt / terminal to terminal		32,2 32,2		mm
Luftstrecke Clearance	Kontakt - Kühlkörper / terminal to heatsink Kontakt - Kontakt / terminal to terminal		19,1 19,1		mm
Vergleichszahl der Kriechwegbildung Comperative tracking index		CTI	> 400		
			min.	typ.	max.
Modulstreuinduktivität Stray inductance module		L <sub>SCE</sub>		12	nH
Modulleitungswiderstand, Anschlüsse - Chip Module lead resistance, terminals - chip	T <sub>c</sub> = 25°C, pro Schalter / per switch	R <sub>CC+EE'</sub> R <sub>AA'+CC'</sub>		0,19 0,34	mΩ
Lagertemperatur Storage temperature		T <sub>stg</sub>	-40		125 °C
Anzugsdrehmoment f. Modulmontage Mounting torque for modul mounting	Schraube M6 - Montage gem. gültiger Applikationsschrift Screw M6 - Mounting according to valid application note	M	4,25	-	5,75 Nm
Anzugsdrehmoment f. elektr. Anschlüsse Terminal connection torque	Schraube M4 - Montage gem. gültiger Applikationsschrift Screw M4 - Mounting according to valid application note Schraube M8 - Montage gem. gültiger Applikationsschrift Screw M8 - Mounting according to valid application note	M	1,8 8,0	-	2,1 10 Nm
Gewicht Weight		G		1500	g

prepared by: SB	date of publication: 2013-11-25
approved by: DTS	revision: 2.3

**Vorläufige Daten**  
**Preliminary Data**

**Ausgangskennlinie IGBT, Brems-Chopper (typisch)**  
**output characteristic IGBT, Brake-Chopper (typical)**

$I_C = f(V_{CE})$   
 $V_{GE} = 15\text{ V}$

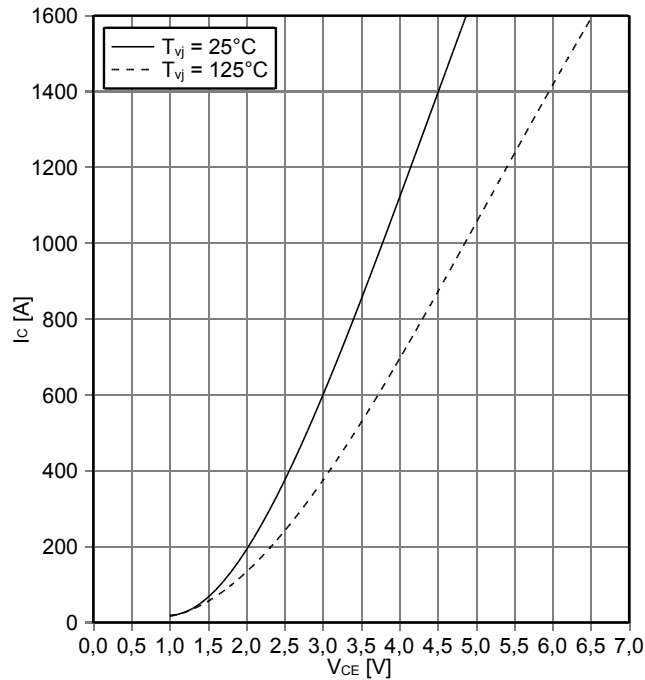

**Ausgangskennlinienfeld IGBT, Brems-Chopper (typisch)**  
**output characteristic IGBT, Brake-Chopper (typical)**

$I_C = f(V_{CE})$   
 $T_{vj} = 125^\circ\text{C}$

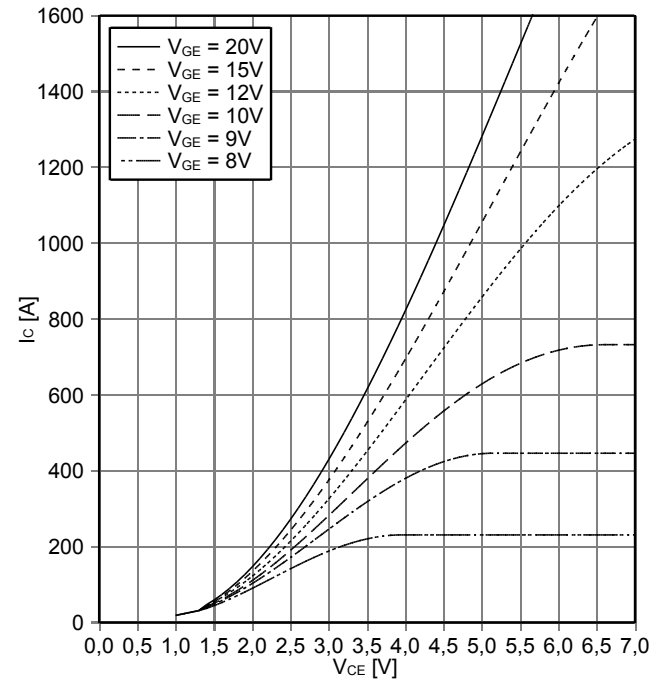

**Übertragungscharakteristik IGBT, Brems-Chopper (typisch)**  
**transfer characteristic IGBT, Brake-Chopper (typical)**

$I_C = f(V_{GE})$   
 $V_{CE} = 20\text{ V}$

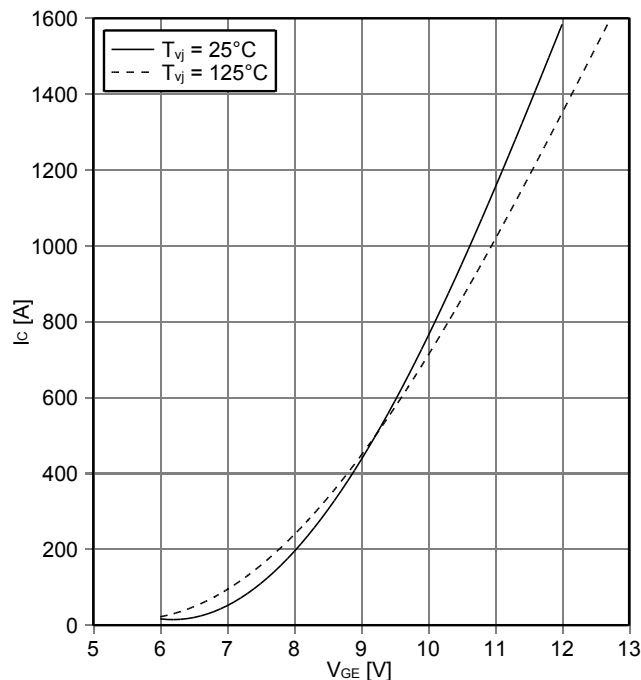

**Schaltverluste IGBT, Brems-Chopper (typisch)**  
**switching losses IGBT, Brake-Chopper (typical)**

$E_{on} = f(I_C), E_{off} = f(I_C)$   
 $V_{GE} = \pm 15\text{ V}, R_{Gon} = 1.4\ \Omega, R_{Goff} = 1.8\ \Omega, V_{CE} = 1800\text{ V}, C_{GE} = 150\text{ nF}$

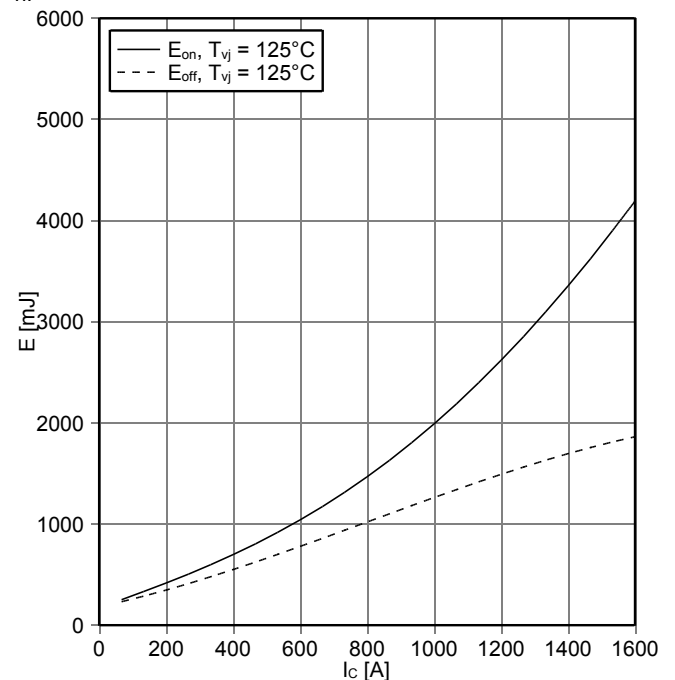

prepared by: SB	date of publication: 2013-11-25
approved by: DTS	revision: 2.3



Vorläufige Daten  
Preliminary Data

Schaltverluste IGBT, Brems-Chopper (typisch)  
switching losses IGBT, Brake-Chopper (typical)

$E_{on} = f(R_G)$ ,  $E_{off} = f(R_G)$   
 $V_{GE} = \pm 15\text{ V}$ ,  $I_C = 800\text{ A}$ ,  $V_{CE} = 1800\text{ V}$ ,  $C_{GE} = 150\text{ nF}$

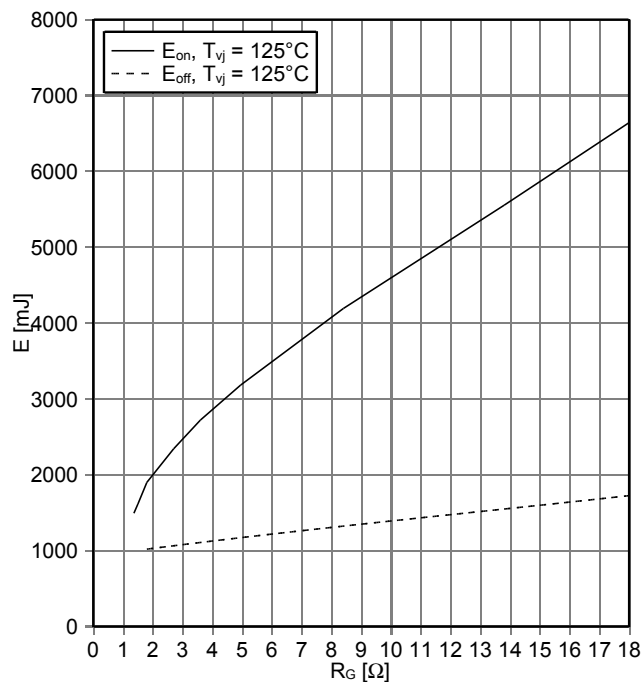

Transienter Wärmewiderstand IGBT, Brems-Chopper  
transient thermal impedance IGBT, Brake-Chopper

$Z_{thJC} = f(t)$

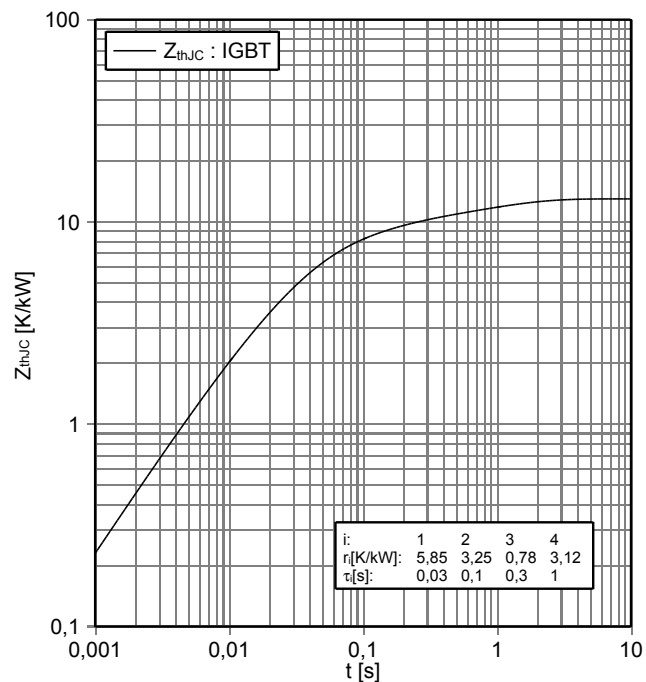

Sicherer Rückw.-Arbeitsber. IGBT, Brems-Chopper (RBSOA)  
reverse bias safe operating area IGBT, Brake-Chopper (RBSOA)

$I_C = f(V_{CE})$   
 $V_{GE} = \pm 15\text{ V}$ ,  $R_{Goff} = 1.8\ \Omega$ ,  $T_{vj} = 125^\circ\text{C}$ ,  $C_{GE} = 150\text{ nF}$

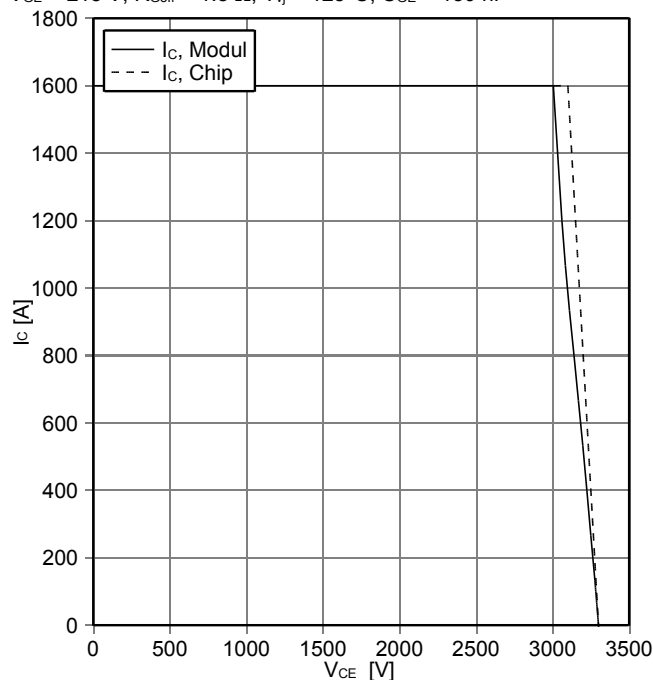

Durchlasskennlinie der Diode, Brems-Chopper (typisch)  
forward characteristic of Diode, Brake-Chopper (typical)

$I_F = f(V_F)$

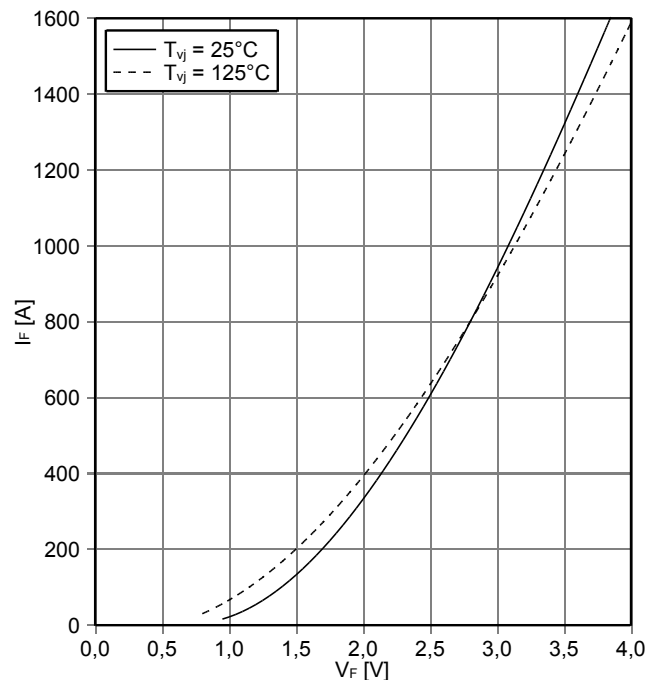

prepared by: SB	date of publication: 2013-11-25
approved by: DTS	revision: 2.3

**Vorläufige Daten**  
**Preliminary Data**

**Schaltverluste Diode, Brems-Chopper (typisch)**  
**switching losses Diode, Brake-Chopper (typical)**

$E_{rec} = f(I_F)$   
 $R_{Gon} = 1.4 \Omega, V_{CE} = 1800 V$

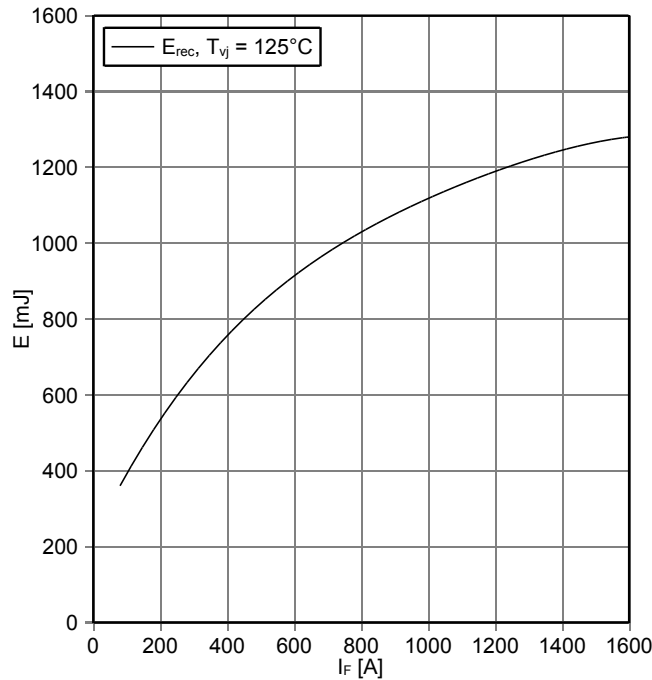

**Schaltverluste Diode, Brems-Chopper (typisch)**  
**switching losses Diode, Brake-Chopper (typical)**

$E_{rec} = f(R_G)$   
 $I_F = 800 A, V_{CE} = 1800 V$

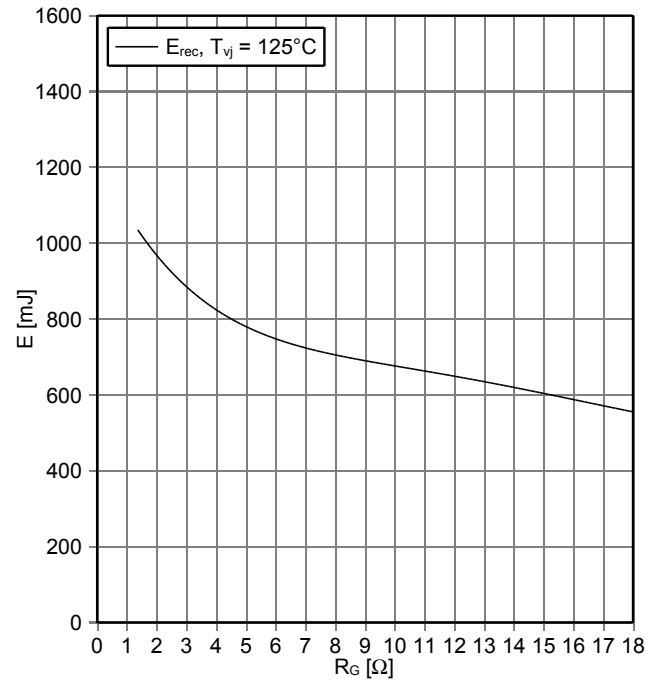

**Transienter Wärmewiderstand Diode, Brems-Chopper**  
**transient thermal impedance Diode, Brake-Chopper**

$Z_{thJC} = f(t)$

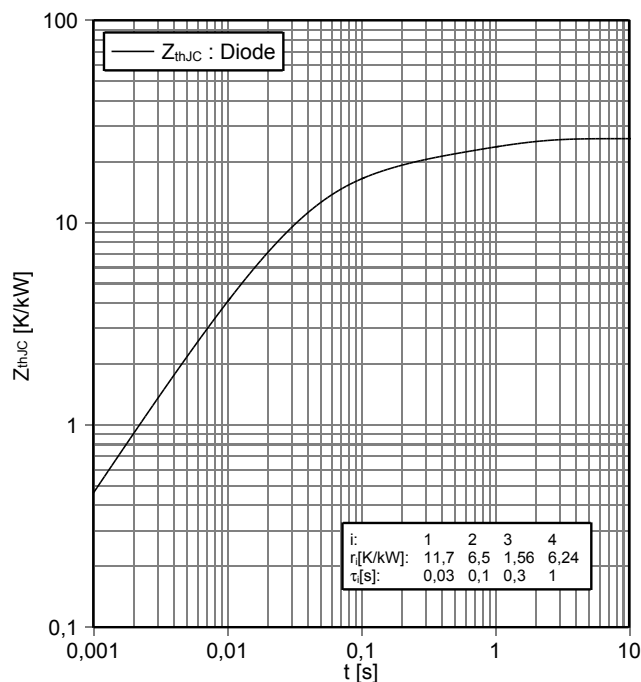

i:	1	2	3	4
r_i [K/kW]:	11,7	6,5	1,56	6,24
τ_i [s]:	0,03	0,1	0,3	1

**Sicherer Arbeitsbereich Diode, Brems-Chopper (SOA)**  
**safe operation area Diode, Brake-Chopper (SOA)**

$I_R = f(V_R)$   
 $T_{vj} = 125^\circ C$

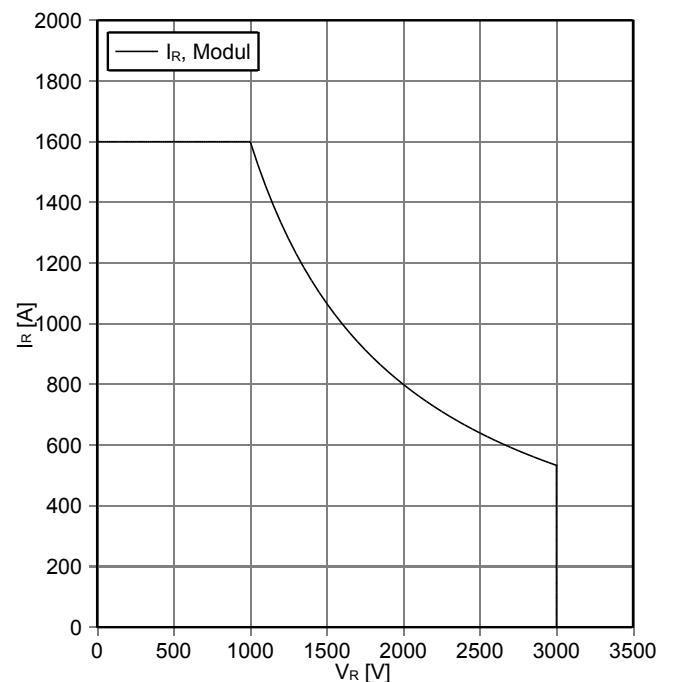

prepared by: SB	date of publication: 2013-11-25
approved by: DTS	revision: 2.3





**Vorläufige Daten**  
**Preliminary Data**

**Durchlasskennlinie der Diode, Revers (typisch)**  
**forward characteristic of Diode, Reverse (typical)**  
 $I_F = f(V_F)$

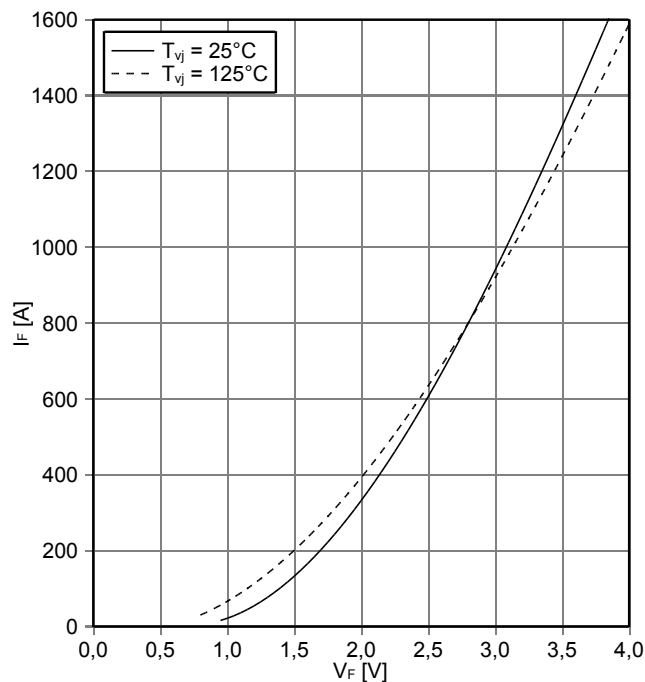

**Schaltverluste Diode, Revers (typisch)**  
**switching losses Diode, Reverse (typical)**  
 $E_{rec} = f(I_F)$

$R_{Gon} = 1.4 \Omega, V_{CE} = 1800 V$

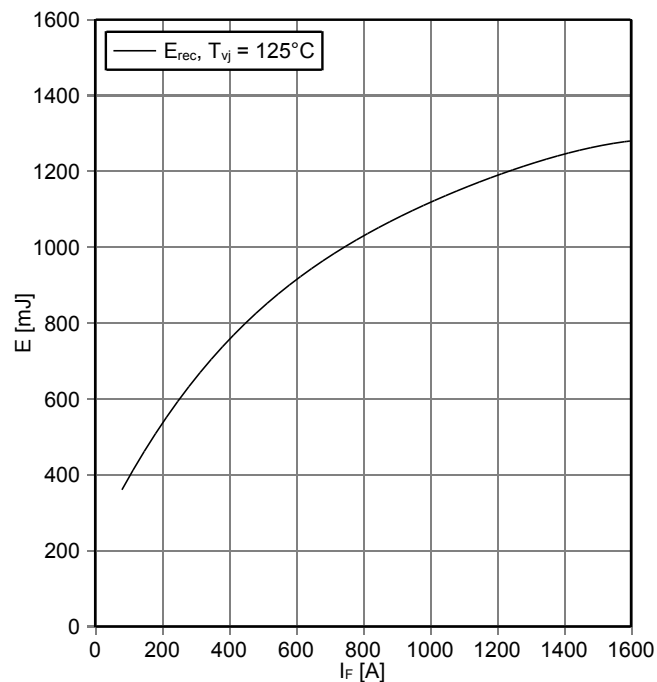

**Schaltverluste Diode, Revers (typisch)**  
**switching losses Diode, Reverse (typical)**  
 $E_{rec} = f(R_G)$

$I_F = 800 A, V_{CE} = 1800 V$

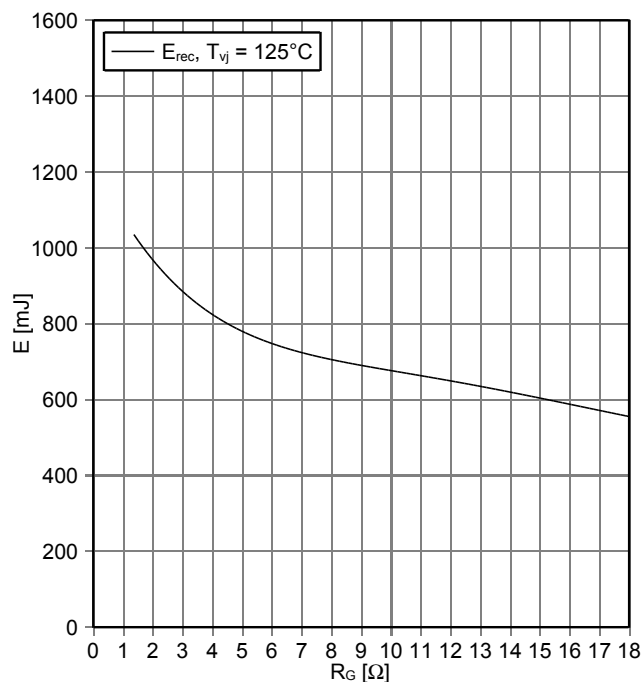

**Transienter Wärmewiderstand Diode, Revers**  
**transient thermal impedance Diode, Reverse**  
 $Z_{thJC} = f(t)$

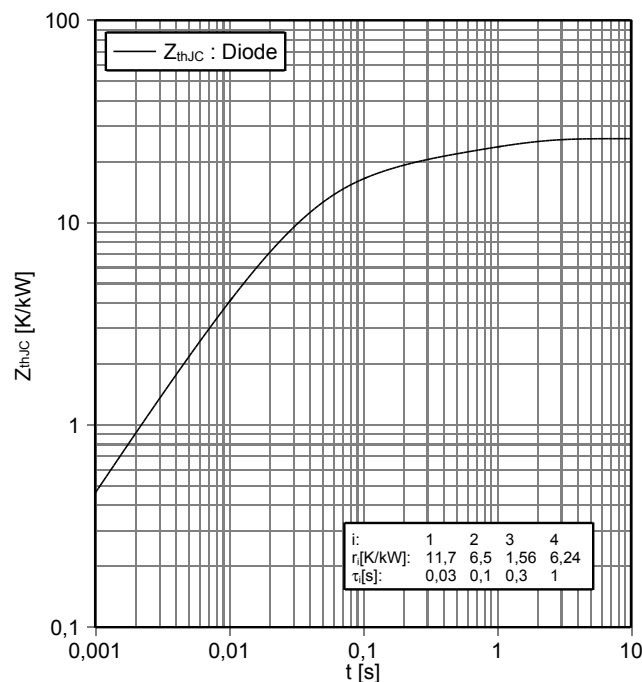

prepared by: SB	date of publication: 2013-11-25
approved by: DTS	revision: 2.3



**Vorläufige Daten**  
**Preliminary Data**

**Sicherer Arbeitsbereich Diode, Revers (SOA)**  
**safe operation area Diode, Reverse (SOA)**

$I_R = f(V_R)$   
 $T_{vj} = 125^\circ\text{C}$

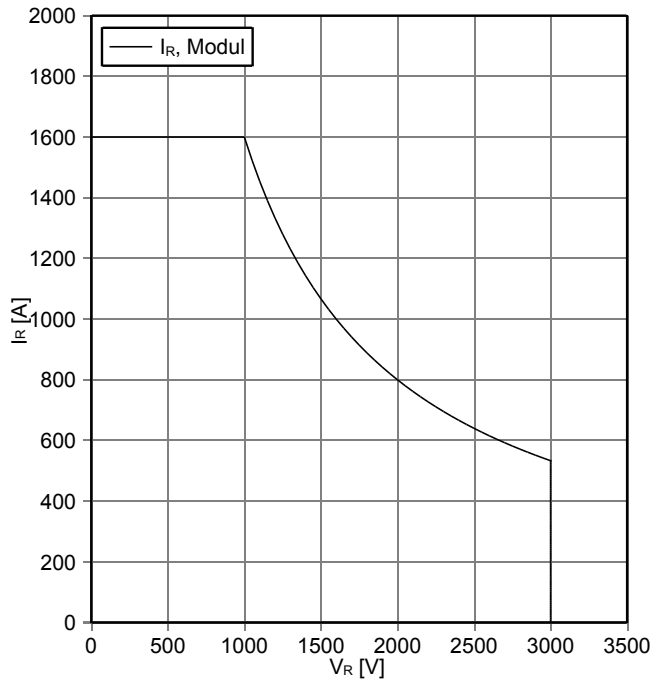

prepared by: SB	date of publication: 2013-11-25
approved by: DTS	revision: 2.3





**Vorläufige Daten  
Preliminary Data**

**Nutzungsbedingungen**

Die in diesem Produktdatenblatt enthaltenen Daten sind ausschließlich für technisch geschultes Fachpersonal bestimmt. Die Beurteilung der Eignung dieses Produktes für Ihre Anwendung sowie die Beurteilung der Vollständigkeit der bereitgestellten Produktdaten für diese Anwendung obliegt Ihnen bzw. Ihren technischen Abteilungen.

In diesem Produktdatenblatt werden diejenigen Merkmale beschrieben, für die wir eine liefervertragliche Gewährleistung übernehmen. Eine solche Gewährleistung richtet sich ausschließlich nach Maßgabe der im jeweiligen Liefervertrag enthaltenen Bestimmungen. Garantien jeglicher Art werden für das Produkt und dessen Eigenschaften keinesfalls übernommen. Die Angaben in den gültigen Anwendungs- und Montagehinweisen des Moduls sind zu beachten.

Sollten Sie von uns Produktinformationen benötigen, die über den Inhalt dieses Produktdatenblatts hinausgehen und insbesondere eine spezifische Verwendung und den Einsatz dieses Produktes betreffen, setzen Sie sich bitte mit dem für Sie zuständigen Vertriebsbüro in Verbindung (siehe [www.infineon.com](http://www.infineon.com), Vertrieb&Kontakt). Für Interessenten halten wir Application Notes bereit.

Aufgrund der technischen Anforderungen könnte unser Produkt gesundheitsgefährdende Substanzen enthalten. Bei Rückfragen zu den in diesem Produkt jeweils enthaltenen Substanzen setzen Sie sich bitte ebenfalls mit dem für Sie zuständigen Vertriebsbüro in Verbindung.

Sollten Sie beabsichtigen, das Produkt in Anwendungen der Luftfahrt, in gesundheits- oder lebensgefährdenden oder lebenserhaltenden Anwendungsbereichen einzusetzen, bitten wir um Mitteilung. Wir weisen darauf hin, dass wir für diese Fälle

- die gemeinsame Durchführung eines Risiko- und Qualitätsassessments;
- den Abschluss von speziellen Qualitätssicherungsvereinbarungen;
- die gemeinsame Einführung von Maßnahmen zu einer laufenden Produktbeobachtung dringend empfehlen und gegebenenfalls die Belieferung von der Umsetzung solcher Maßnahmen abhängig machen.

Soweit erforderlich, bitten wir Sie, entsprechende Hinweise an Ihre Kunden zu geben.

Inhaltliche Änderungen dieses Produktdatenblatts bleiben vorbehalten.

**Terms & Conditions of usage**

The data contained in this product data sheet is exclusively intended for technically trained staff. You and your technical departments will have to evaluate the suitability of the product for the intended application and the completeness of the product data with respect to such application.

This product data sheet is describing the characteristics of this product for which a warranty is granted. Any such warranty is granted exclusively pursuant the terms and conditions of the supply agreement. There will be no guarantee of any kind for the product and its characteristics. The information in the valid application- and assembly notes of the module must be considered.

Should you require product information in excess of the data given in this product data sheet or which concerns the specific application of our product, please contact the sales office, which is responsible for you ( see [www.infineon.com](http://www.infineon.com) ). For those that are specifically interested we may provide application notes.

Due to technical requirements our product may contain dangerous substances. For information on the types in question please contact the sales office, which is responsible for you.

Should you intend to use the Product in aviation applications, in health or live endangering or life support applications, please notify. Please note, that for any such applications we urgently recommend

- to perform joint Risk and Quality Assessments;
- the conclusion of Quality Agreements;
- to establish joint measures of an ongoing product survey, and that we may make delivery depended on the realization of any such measures.

If and to the extent necessary, please forward equivalent notices to your customers.

Changes of this product data sheet are reserved.

prepared by: SB	date of publication: 2013-11-25
approved by: DTS	revision: 2.3