

SAGA-HB-IP-WHT

~60° high bay beam

TECHNICAL SPECIFICATIONS:

Dimensions	Ø 50 mm
Height	12 mm
Fastening	screw
Colour	clear
Box size	480 x 280 x 300 mm
Box weight	0 kg
Quantity in Box	520 pcs
ROHS compliant	yes ⓘ

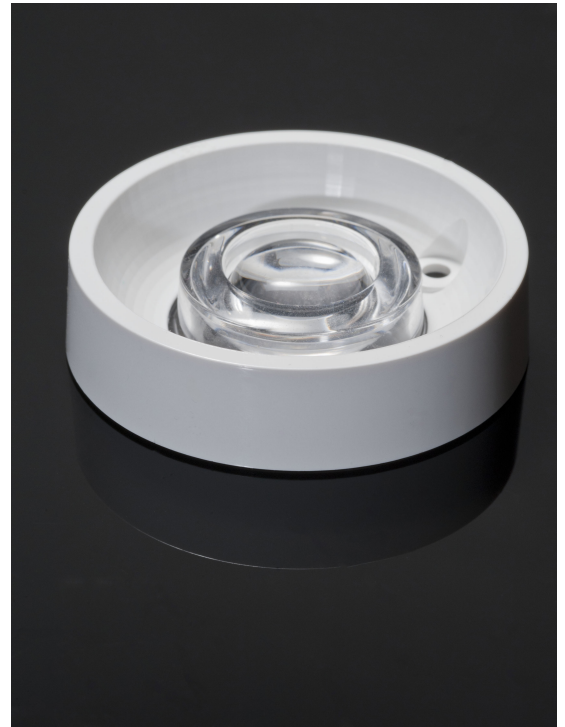

MATERIAL SPECIFICATIONS:

Component	Type	Material	Colour
SAGA-HB-IP	Lens	Silicone	clear
SAGA-FRAME-WHT	Reflector	HRPC	white

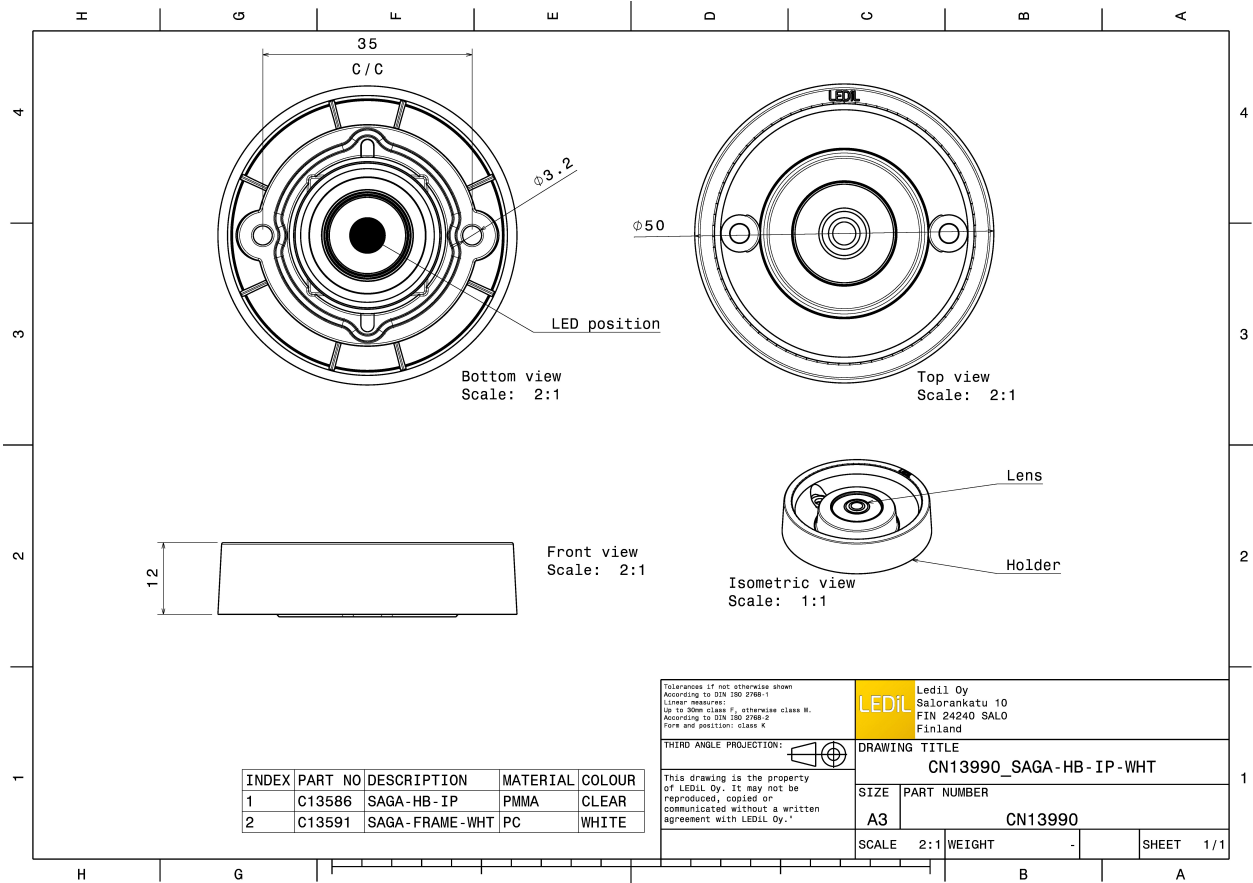

PHOTOMETRIC DATA (MEASURED):

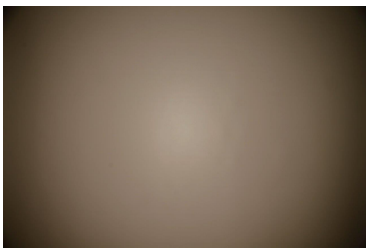
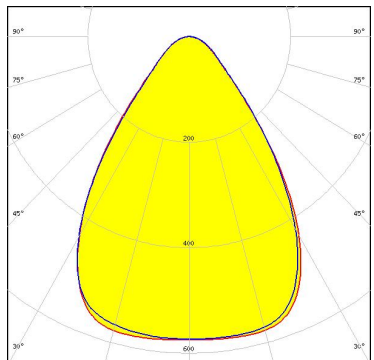
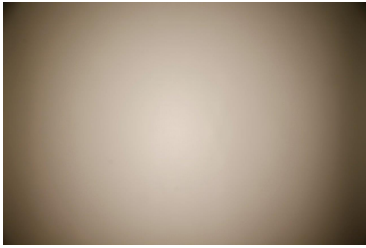
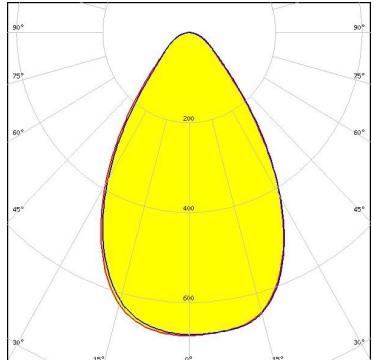
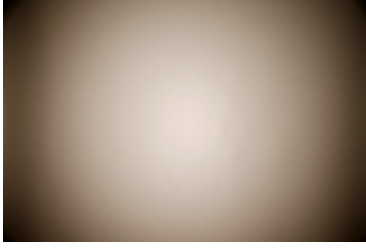
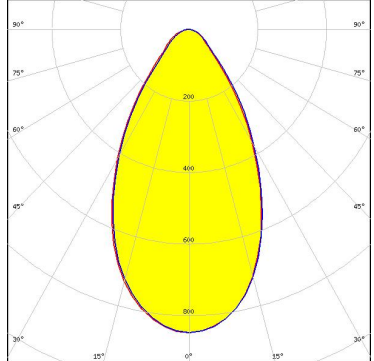
<p>bridgelux.</p> <p>LED V10 Gen6 FWHM 58.0° Efficiency 89 % Peak intensity 0.830 cd/lm Required components:</p>		
<p>bridgelux.</p> <p>LED V6 Gen6 FWHM 73.0° Efficiency 88 % Peak intensity 0.600 cd/lm Required components:</p>		
<p>bridgelux.</p> <p>LED V8 Gen6 FWHM 66.0° Efficiency 88 % Peak intensity 0.670 cd/lm Required components:</p>		
<p>bridgelux.</p> <p>LED VERO10 FWHM 58.0° Efficiency 92 % Peak intensity 0.850 cd/lm Required components:</p>		

PHOTOMETRIC DATA (MEASURED):

CITIZEN

LED CLL01x
FWHM 61.0°
Efficiency 92 %
Peak intensity 0.840 cd/lm
Required components:

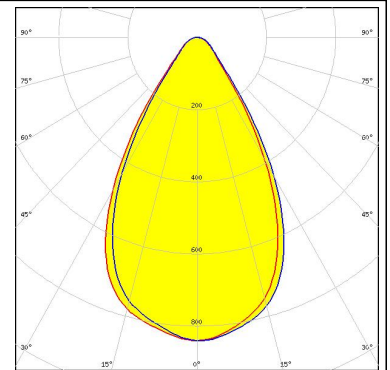

CITIZEN

LED CLL02x/CLU02x (LES10)
FWHM 47.0°
Efficiency 86 %
Peak intensity 1.000 cd/lm
Required components:
Bender Wirth: 434 Typ L6

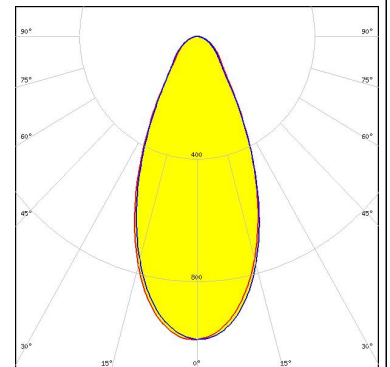
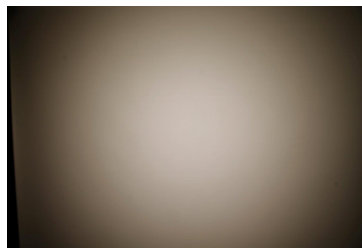

CITIZEN

LED CLL02x/CLU02x (LES10)
FWHM 58.0°
Efficiency 91 %
Peak intensity 0.860 cd/lm
Required components:

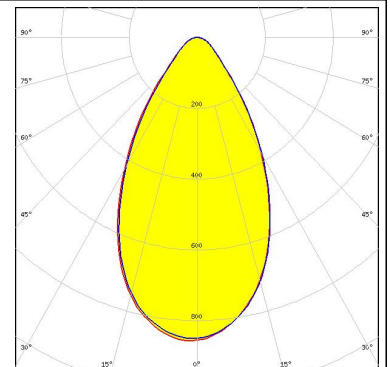
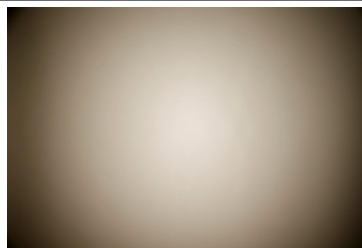

CITIZEN

LED CLL03x/CLU03x
FWHM 61.0°
Efficiency 84 %
Peak intensity 0.610 cd/lm
Required components:
Bender Wirth: 433 Typ L6

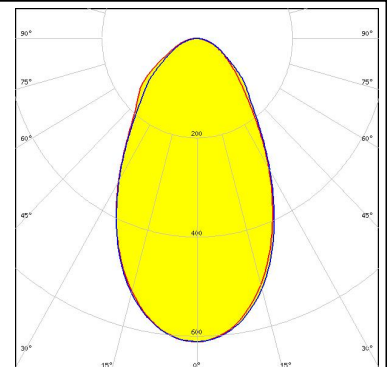
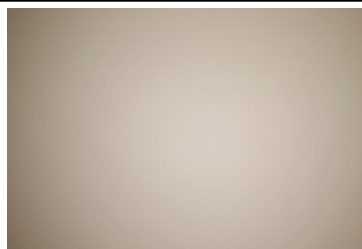

PHOTOMETRIC DATA (MEASURED):

CITIZEN

LED CLL03x/CLU03x
FWHM 64.0°
Efficiency 92 %
Peak intensity 0.700 cd/lm
Required components:

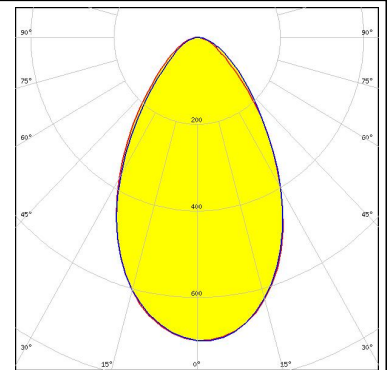
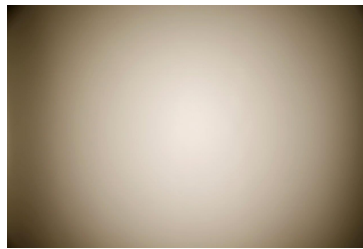

CITIZEN

LED CLU700/701
FWHM 46.0°
Efficiency 86 %
Peak intensity 1.100 cd/lm
Required components:
 Bender Wirth: 434 Typ L6

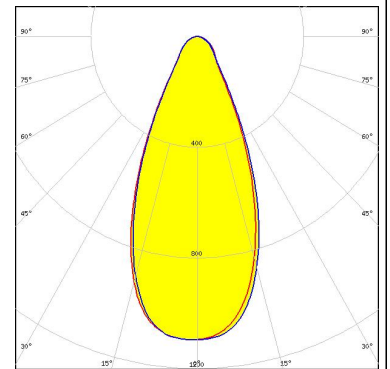
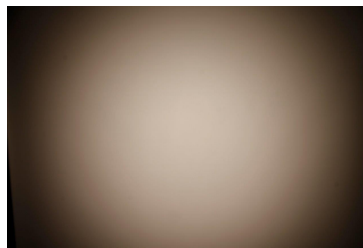

CITIZEN

LED CLU700/701
FWHM 56.0°
Efficiency 87 %
Peak intensity 0.900 cd/lm
Required components:

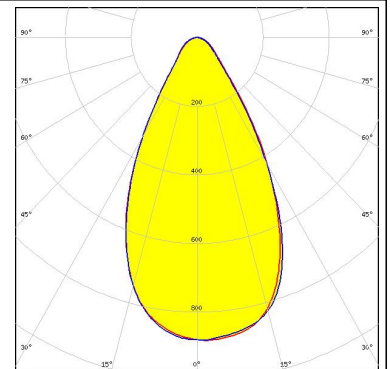
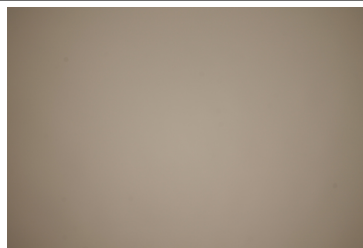

CITIZEN

LED CLU710/711
FWHM 62.0°
Efficiency 90 %
Peak intensity 0.700 cd/lm
Required components:

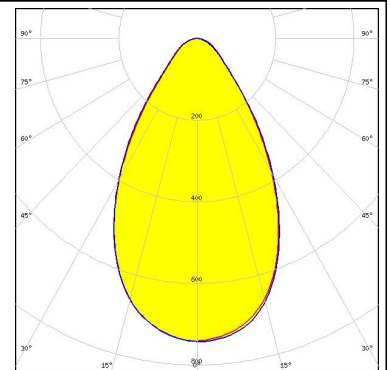
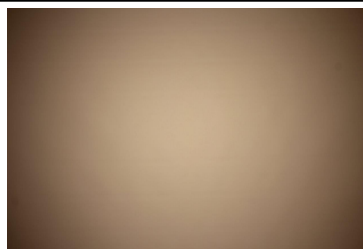

PHOTOMETRIC DATA (MEASURED):

CITIZEN

LED CLU720/721
 FWHM 61.0°
 Efficiency 89 %
 Peak intensity 0.730 cd/lm
 Required components:

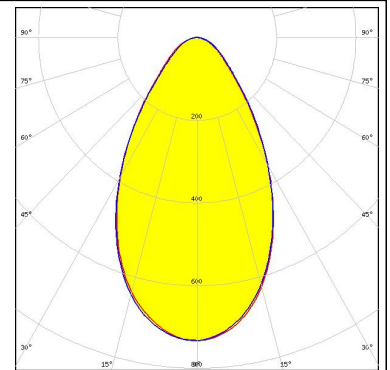
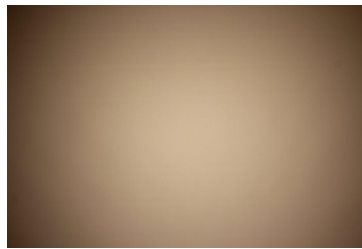

CITIZEN

LED CLU720/721
 FWHM 50.0°
 Efficiency 85 %
 Peak intensity 0.850 cd/lm
 Required components:
 Bender Wirth: 433 Typ L6

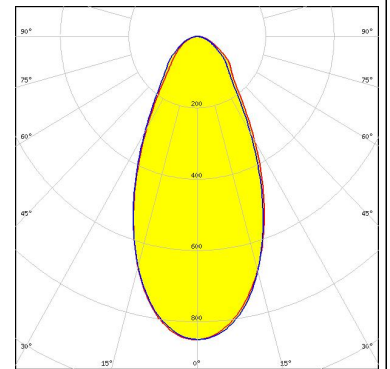
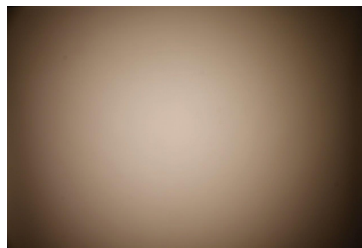

CREE

LED CXA/B 13xx
 FWHM 70.0°
 Efficiency 92 %
 Peak intensity 0.680 cd/lm
 Required components:

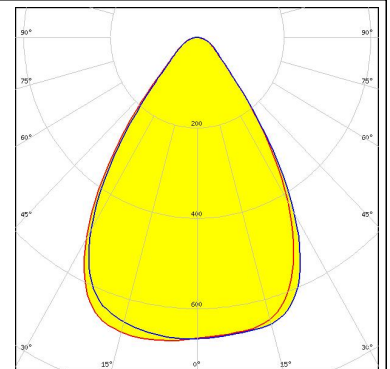
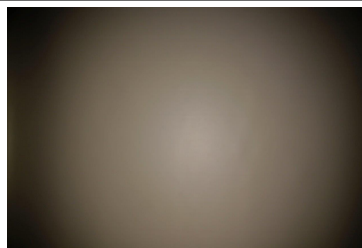

CREE

LED CXA/B 15xx
 FWHM 64.0°
 Efficiency 90 %
 Peak intensity 0.750 cd/lm
 Required components:

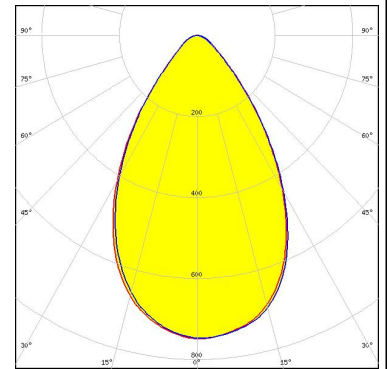
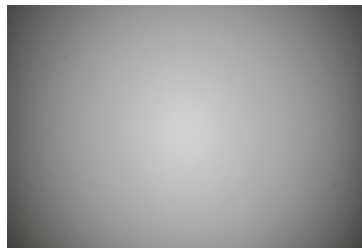

PHOTOMETRIC DATA (MEASURED):



LED CXA/B 15xx
 FWHM 64.0°
 Efficiency 92 %
 Peak intensity 0.750 cd/lm
 Required components:

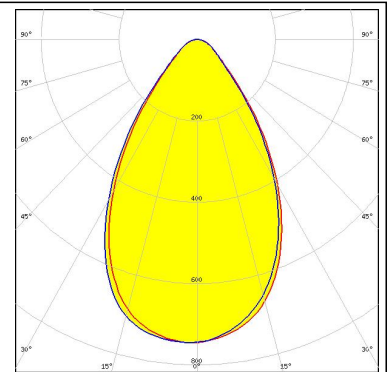
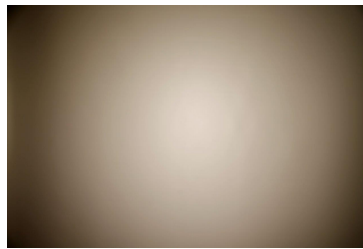

LED CXA/B 1816 & CXA/B 1820 & CXA 1850
 FWHM 63.0°
 Efficiency 90 %
 Peak intensity 0.730 cd/lm
 Required components:

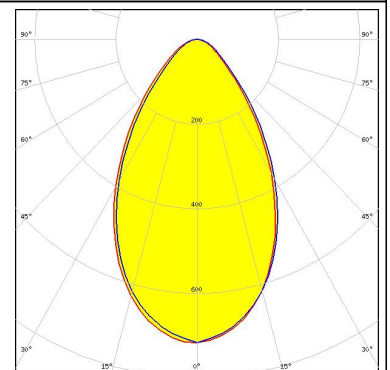
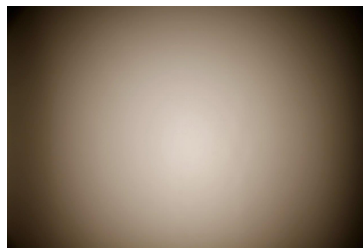

LED MHD-E/G
 FWHM 60.0°
 Efficiency 90 %
 Peak intensity 0.780 cd/lm
 Required components:

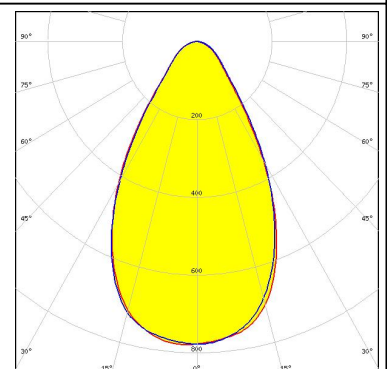
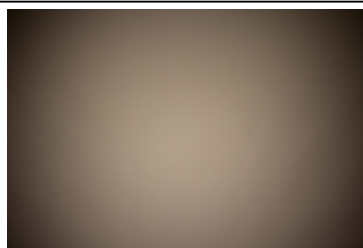

LED LUXEON CoB 1202/1203
 FWHM 63.0°
 Efficiency 89 %
 Peak intensity 0.730 cd/lm
 Required components:

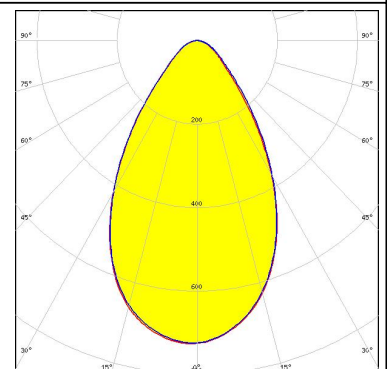
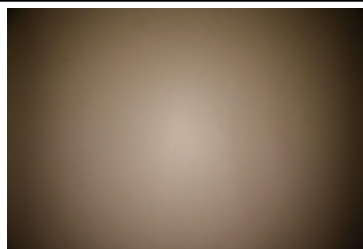

PHOTOMETRIC DATA (MEASURED):



LED LUXEON CoB 1202s
FWHM 67.0°
Efficiency 90 %
Peak intensity 0.700 cd/lm
Required components:

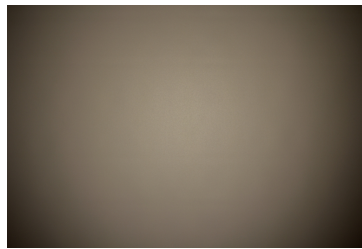

LED CXM-14
FWHM 66.0°
Efficiency 88 %
Peak intensity 0.640 cd/lm
Required components:

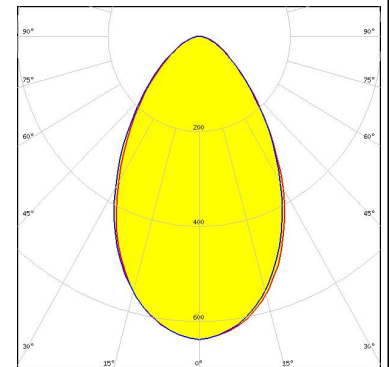
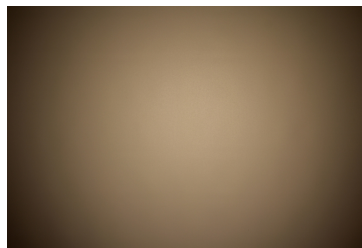

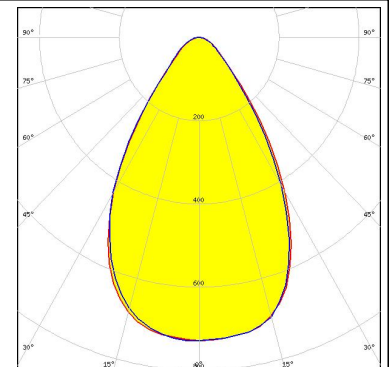
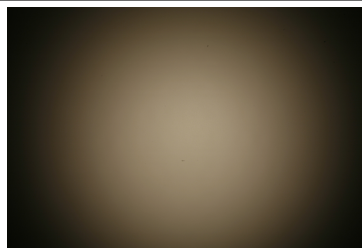

LED CXM-6
FWHM 66.0°
Efficiency 89 %
Peak intensity 0.730 cd/lm
Required components:



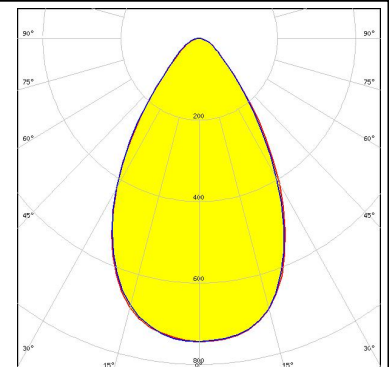
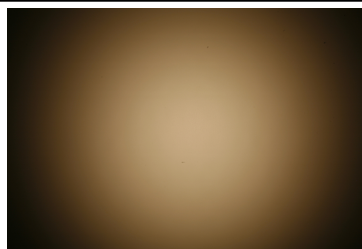

LED CXM-7
FWHM 64.0°
Efficiency 89 %
Peak intensity 0.750 cd/lm
Required components:

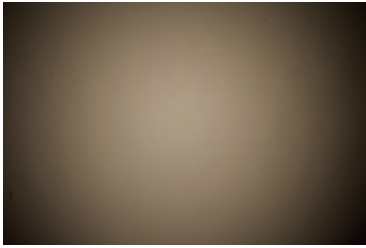
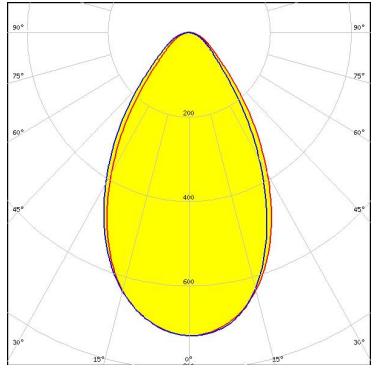
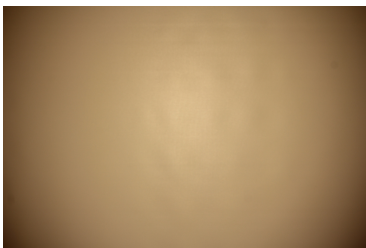

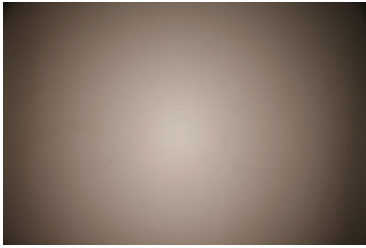
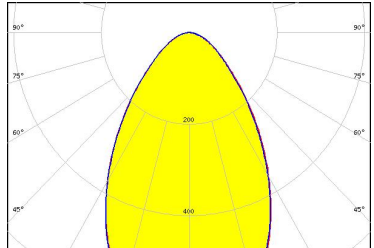
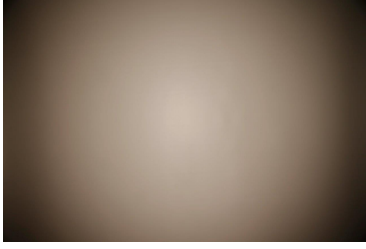
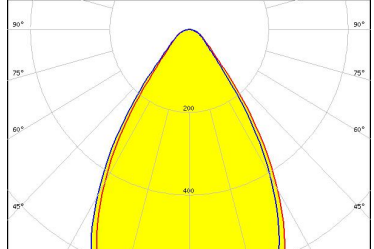
PHOTOMETRIC DATA (MEASURED):

<p>LUMINUS</p> <p>LED CXM-9 FWHM 63.0° Efficiency 88 % Peak intensity 0.720 cd/lm Required components:</p>		
<p>OSRAM <small>Opto Semiconductors</small></p> <p>LED Duris S10 FWHM 74.0° Efficiency 91 % Peak intensity 0.670 cd/lm Required components:</p>		
<p>OSRAM <small>Opto Semiconductors</small></p> <p>LED Soleriq P13 FWHM 64.0° Efficiency 89 % Peak intensity 0.660 cd/lm Required components:</p>		
<p>OSRAM <small>Opto Semiconductors</small></p> <p>LED Soleriq P6 FWHM 65.0° Efficiency 89 % Peak intensity 0.840 cd/lm Required components:</p>		

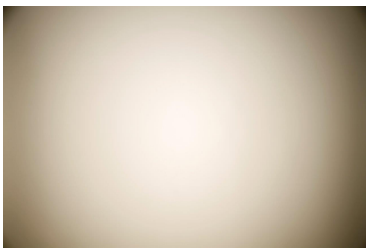
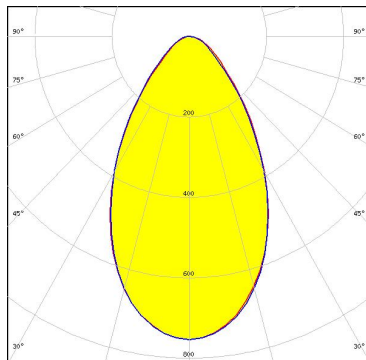
PHOTOMETRIC DATA (MEASURED):

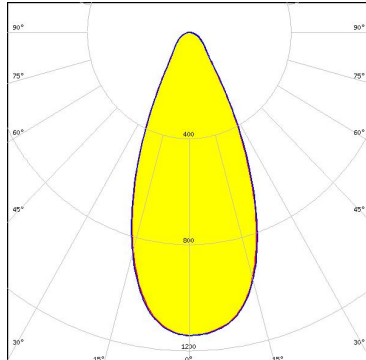
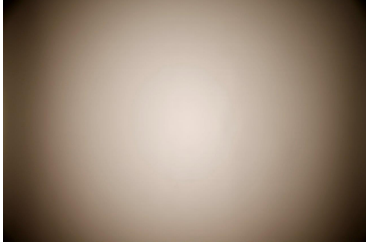
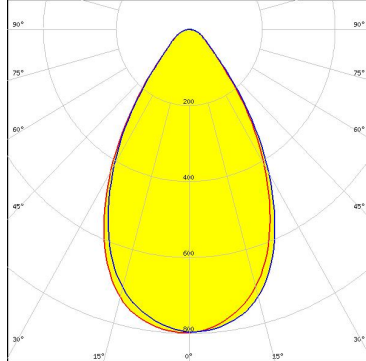
<p>OSRAM Opto Semiconductors</p> <p>LED Soleriq P9 FWHM 58.0° Efficiency 90 % Peak intensity 0.840 cd/lm Required components:</p>		
<p>OSRAM Opto Semiconductors</p> <p>LED Soleriq S13 FWHM 61.0° Efficiency 91 % Peak intensity 0.800 cd/lm Required components:</p>		
<p>SEOL SEOUL SEMICONDUCTOR</p> <p>LED MJT COB LES 6 FWHM 46.0° Efficiency 87 % Peak intensity 1.100 cd/lm Required components: Bender Wirth: 434 Typ L6</p>		
<p>SHARP</p> <p>LED Mini Zenigata (GW6BM) FWHM 62.0° Efficiency 92 % Peak intensity 0.800 cd/lm Required components:</p>		

PHOTOMETRIC DATA (MEASURED):

TRIDONIC

LED SLE G5 LES6

FWHM 64.0°

Efficiency 89 %

Peak intensity 0.800 cd/lm

Required components:

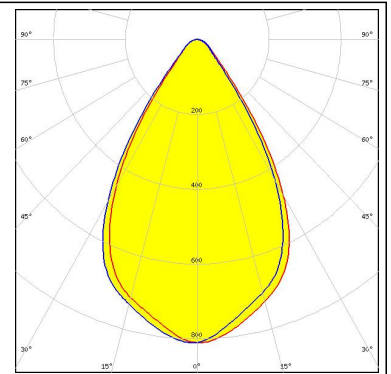
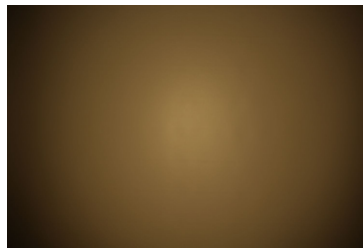

PHOTOMETRIC DATA (SIMULATED):

LUMILEDS

LED LUXEON CoB Compact
FWHM 67.0°
Efficiency 90 %
Peak intensity 0.700 cd/lm
Required components:

LUMINUS

LED CXM-14
FWHM 61.0°
Efficiency 84 %
Peak intensity 0.610 cd/lm
Required components:
Bender Wirth: 433 Typ L6

LUMINUS

LED CXM-9
FWHM 47.0°
Efficiency 86 %
Peak intensity 1.000 cd/lm
Required components:
Bender Wirth: 434 Typ L6

OSRAM Opto Semiconductors

LED Soleriq S9
FWHM 56.0°
Efficiency 93 %
Peak intensity 1.100 cd/lm
Required components:

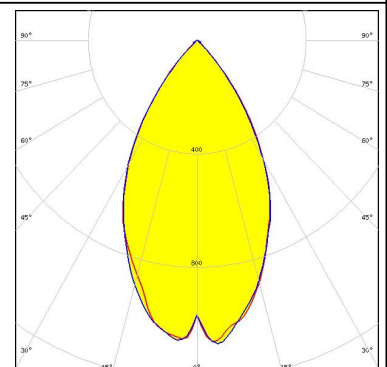

PHOTOMETRIC DATA (SIMULATED):

SAMSUNG

LED LC020C
FWHM 42.0°
Efficiency 87 %
Peak intensity 1.600 cd/lm
Required components:
Bender Wirth: 479 Typ L6

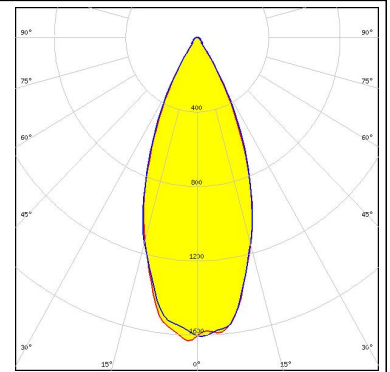

SAMSUNG

LED LC040C
FWHM 51.0°
Efficiency 87 %
Peak intensity 1.100 cd/lm
Required components:
Bender Wirth: 480 Typ L6

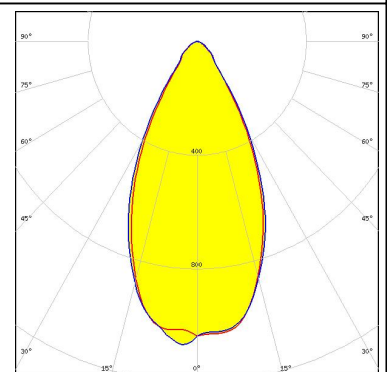

SEOUL SEMICONDUCTOR

LED ZC12/18
FWHM 61.0°
Efficiency 84 %
Peak intensity 0.610 cd/lm
Required components:
Bender Wirth: 433 Typ L6



SEOUL SEMICONDUCTOR

LED ZC4/6
FWHM 47.0°
Efficiency 86 %
Peak intensity 1.000 cd/lm
Required components:
Bender Wirth: 434 Typ L6

GENERAL INFORMATION:

NOTE: The typical beam angle will be changed by different color, chip size and chip position tolerance. The typical total beam angle is the full angle measured where the luminous intensity is half of the peak value.

Due to use of high power COB's with this product, special attention to proper thermal design is highly recommended. LEDiL has no liability for direct, indirect or consecutive damages arising from the LEDiL products being used outside of the recommended temperature range.

MATERIALS:

As part of our continuous research and improvement processes, and to ensure the best possible quality and availability of our products, LEDiL reserves the right to change material grades without notice.

PRODUCT DATA USER AGREEMENT AND DISCLAIMER:

The measured data in the provided downloadable LEDiL Product Datasheets and Mechanical 2D-Drawings is rounded and provided as reference for planning. LEDiL Oy's optical specifications have been verified by conducting performance testing of the products in accordance with the company's quality system. The reported data are averaged results of multiple measurements with typical variation. LEDiL Oy reserves the right to without prior notification make changes and improvements to its products.

LEDiL Oy assumes neither warranty, nor guarantee nor any other liability of any kind for the contents and correctness of the provided data. The provided data has been generated with highest diligence but the provided data may in reality not represent the complete possible variation range of all intrinsic parameters. Therefore, in certain cases a deviation from the provided data could occur.

LEDiL Oy reserves the right to undertake technical changes of its products without further notification which could lead to changes in the provided data. LEDiL Oy assumes no liability of any kind for the possible deviation from any provided data or any other damage resulting from the usage of the provided data.

The user agrees to this disclaimer and user agreement with the download or usage of the provided files.

LEDiL Oy

Joensuunkatu 13
FI-24240 SALO
Finland

LEDiL Inc.

228 West Page Street
Suite D
Sycamore IL 60178
USA

Local sales and technical support

www.ledil.com/where_to_buy

Shipping locations

Salo, Finland
Hong Kong, China

Distribution Partners

www.ledil.com/where_to_buy